

The image features a modern interior scene with a black track lighting fixture mounted on a ceiling. The fixture is illuminated, casting a warm glow. In the background, there are green plants and a white wall. The image is framed by blue geometric shapes: a large triangle in the top-left and another in the bottom-left. The Kanlux logo is positioned in the top-left blue triangle, and the text 'more than light.' is in the bottom-left blue triangle. The main text 'Katalog Catalogue 2024' is located in the bottom-right area of the image.

# ***Kanlux***

**more than  
light.**

**Katalog**  
Catalogue  
20**24**

**more than**  
more than **light.**  
light.

# ***Kanlux***





**14**  
33

**LEUCHTEN AUS DER KANLUX-FABRIK**  
KANLUX FACTORY FIXTURES

**34**  
101

**LEUCHTMITTEL**  
LIGHT SOURCES

**102**  
205

**WOHNRAUMLEUCHTEN UND DEKORATIVE LEUCHTEN**  
DOMESTIC AND DECORATIVE FIXTURES

**206**  
313

**TECHNISCHE LEUCHTEN UND ARCHITEKTURLEUCHTEN**  
TECHNICAL AND ARCHITECTURAL FIXTURES

**314**  
351

**ELEKTROINSTALLATIONSZUBEHÖR**  
ELECTRICAL INSTALLATION EQUIPMENT

**LEUCHTEN  
AUS DER  
KANLUX-FABRIK**  
KANLUX  
FACTORY  
FIXTURES

**Kanlux**  
**F**ACTORY



Kanlux ALIN LED  
◀ 16 - 17 ▶



Kanlux ALIN LED LINE  
◀ 18 - 19 ▶

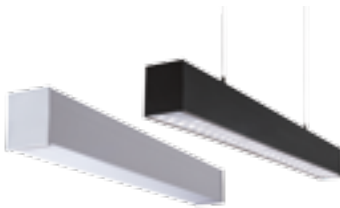

Kanlux ALIN 4LED  
◀ 20 - 21 ▶

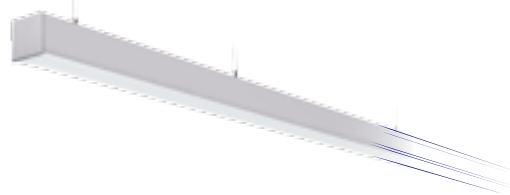

Kanlux ALIN 4LED LINE  
◀ 22 - 23 ▶



Kanlux OFIS S LED  
◀ 24 - 25 ▶



Kanlux HIERRO LED  
◀ 26 - 27 ▶



Kanlux FUTURIO LED  
◀ 28 - 29 ▶



Kanlux ADTR  
◀ 30 - 31 ▶

**LEUCHT-  
MITTEL**  
LIGHT  
SOURCES



Kanlux Kanlux SMART  
◀ 36 ▶



Kanlux Kanlux SMART  
◀ 37 ▶



Kanlux IQ-LED LIFE  
◀ 38 ▶



Kanlux IQ-LED LIFE  
◀ 39 ▶



Kanlux IQ-LED A60  
◀ 40 ▶



Kanlux IQ-LED A67  
◀ 41 ▶



Kanlux IQ-LEDDIM A60  
◀ 42 ▶



Kanlux XLED EX A60  
◀ 43 ▶



Kanlux XLED A60  
◀ 44 ▶



Kanlux XLED A70  
◀ 45 ▶



Kanlux XLED A60M  
◀ 46 ▶



Kanlux XLED STEPDIM  
◀ 47 ▶



Kanlux XLEDIM A60  
◀ 47 ▶



Kanlux XLED A60 B22 M  
◀ 48 ▶



Kanlux XLEDIM A60 B22  
◀ 48 ▶



Kanlux RAPIDv2 LED  
◀ 49 ▶



Kanlux ST45 LED  
◀ 50 ▶



Kanlux ST64 A  
◀ 51 ▶



Kanlux XLED ST64  
◀ 51 ▶



Kanlux XLED A60 MIRROR  
◀ 52 ▶



Kanlux XLED G95  
◀ 52 ▶



Kanlux XLED G125  
◀ 53 ▶



Kanlux XLED G125  
◀ 53 ▶



XLED SW  
◀ 54 ▶



XLED W  
◀ 55 ▶



Kanlux IQ-LED C35  
◀ 56 ▶



Kanlux XLEDEX C35  
◀ 57 ▶



Kanlux XLEDDIM C35  
◀ 57 ▶



Kanlux XLED C35  
◀ 58 ▶



Kanlux XLED C35M  
◀ 58 ▶



Kanlux DUN LED  
◀ 59 ▶



Kanlux IDO LED 6,5W  
◀ 59 ▶



Kanlux IQ-LED G45  
◀ 60 ▶



Kanlux XLEDEX G45  
◀ 61 ▶



Kanlux XLED G45  
◀ 62 ▶



Kanlux XLED G45M  
◀ 63 ▶



Kanlux BILO LED  
◀ 64 ▶



Kanlux IQ-LEDEX GU10  
◀ 65 ▶



Kanlux IQ-LED GU10 4,9W  
◀ 65 ▶



Kanlux IQ-LED GU10  
◀ 66 ▶



Kanlux IQ-LEDIM GU10  
◀ 67 ▶



Kanlux K LED GU10 6W  
◀ 67 ▶

**LEUCHT-  
MITTEL**  
LIGHT  
SOURCES



						
Kanlux TOMiv2 LED ◀ 68 ▶	Kanlux REMI LED ◀ 69 ▶	Kanlux TEDI MAXX LED ◀ 69 ▶	Kanlux ZUBI LED ◀ 70 ▶			
						
Kanlux TANO G4 ◀ 71 ▶	Kanlux LEDI2 G4 ◀ 71 ▶	Kanlux IQ-LED AR-111 ◀ 72 ▶	Kanlux IQ-LED ES-111 ◀ 72 ▶	Kanlux IQ-LED EX T8 ◀ 73 ▶	Kanlux T8 LED GLASSv3 ◀ 74 ▶	Kanlux T8 LED GLASSv3T ◀ 74 ▶
						
Kanlux T8 LED GLASSv4 ◀ 75 ▶	Kanlux T8 LED GLASSv5 ◀ 75 ▶	Kanlux TOMI LED ◀ 76 ▶	Kanlux SIGO LED ◀ 76 ▶	Kanlux ESG LED ◀ 77 ▶	Kanlux RANGO LED ◀ 77 ▶	Kanlux MODv2 LED ◀ 78 ▶
						
Kanlux LEDS-B ◀ 79 ▶	Kanlux LED STRIP L60 ◀ 80 ▶	Kanlux LED STRIP L120 ◀ 81 ▶	Kanlux LED STRIP L120 CCT ◀ 82 ▶	Kanlux LED STRIP LCOB 12V ◀ 83 ▶	Kanlux LED STRIP LCOB 24V ◀ 84 ▶	Kanlux LEDS-B RGB ◀ 85 ▶
						
Kanlux LED STRIP L48 RGBW ◀ 86 ▶	Kanlux COB SET ◀ 86 ▶	Kanlux CONTROLLER MONO/CCT ◀ 87 ▶	Kanlux CONTROLLER RGBW CCT ◀ 87 ▶	Kanlux PROFILO B ◀ 88 ▶	Kanlux PROFILO C ◀ 89 ▶	Kanlux PROFILO D ◀ 90 ▶
						
Kanlux PROFILO F ◀ 91 ▶	Kanlux PROFILO G ◀ 92 ▶	Kanlux PROFILO H ◀ 93 ▶	Kanlux PROFILO J ◀ 94 ▶	Kanlux PROFILO K ◀ 95 ▶	Kanlux NEON LEDI2W/M ◀ 96 ▶	Kanlux XLED HP D9 ◀ 98 ▶
						
Kanlux XLED HP D46 ◀ 98 ▶	Kanlux G9 STAR ◀ 99 ▶	Kanlux J ◀ 99 ▶	Kanlux J STAR ◀ 100 ▶	Kanlux T5 ◀ 100 ▶	Kanlux T8 ◀ 101 ▶	Kanlux MHE ◀ 101 ▶

# WOHNRAUM- LEUCHTEN UND DEKORATIVE LEUCHTEN

## DOMESTIC AND DECORATIVE FIXTURES



Kanlux AGZAR C  
◀ 104 ▶



Kanlux GALOBA C  
◀ 104 ▶



Kanlux JASMIN C  
◀ 105 ▶



Kanlux ETISSA  
◀ 106 ▶



Kanlux OGIVA  
◀ 106 ▶



Kanlux SANI IP44  
◀ 107 ▶



Kanlux SONOR GU10  
◀ 107 ▶



Kanlux AQILO IP65  
◀ 108-109 ▶



Kanlux STOBI  
◀ 110 ▶



Kanlux RITI  
◀ 111 ▶



Kanlux BORD  
◀ 111 ▶



Kanlux BORD XS  
◀ 112 ▶



Kanlux GORD XS  
◀ 112 ▶



Kanlux BLURRO  
◀ 113 ▶



Kanlux CARVO LED  
◀ 114 ▶



Kanlux LUMKO LED  
◀ 114 ▶



Kanlux BONSA LED  
◀ 115 ▶



Kanlux EXATE LED  
◀ 115 ▶



Kanlux SOLN LED  
◀ 116 ▶



Kanlux AMAZI LED  
◀ 116 ▶



Kanlux VAND LED  
◀ 117 ▶



Kanlux RIFA LED  
◀ 118-119 ▶



Kanlux ARVOS LED  
◀ 120 ▶



Kanlux JASMIN W  
◀ 121 ▶



Kanlux JASMIN  
◀ 122-123 ▶



Kanlux DERATO  
◀ 124-125 ▶



Kanlux EVALO  
◀ 126-127 ▶



Kanlux SONDA II  
◀ 128-129 ▶



Kanlux GALOBA  
◀ 130-131 ▶



Kanlux LAURIN  
◀ 132-133 ▶



Kanlux SEMPRA  
◀ 134-135 ▶



Kanlux ENALI  
◀ 136-137 ▶



Kanlux MILENO  
◀ 138-139 ▶



Kanlux BOLA LED  
◀ 140 ▶



Kanlux ULUV LED  
◀ 140 ▶



Kanlux ORISA LED  
◀ 141 ▶



Kanlux HOFI LED  
◀ 141 ▶



Kanlux CALIZA LED  
◀ 142 ▶



Kanlux GALOBA W  
◀ 143 ▶



**WOHNRAUM-  
LEUCHTEN  
UND DEKORATIVE  
LEUCHTEN**  
DOMESTIC  
AND DECORATIVE  
FIXTURES



Kanlux TONIL II LED ◀ 143 ▶	Kanlux AGZAR EL ◀ 144 ▶	Kanlux AGZAR E14 ◀ 144 ▶	Kanlux LARATA EL ◀ 145 ▶	Kanlux LARATA E27 ◀ 145 ▶	Kanlux FLUXY LED IP44 ◀ 146 ▶	Kanlux INITA LED IP54 ◀ 147 ▶
Kanlux EVALO TL ◀ 148 ▶	Kanlux EVALO FL ◀ 149 ▶	Kanlux RAIBO E27 ◀ 150 ▶	Kanlux JUJI E27 ◀ 151 ▶	Kanlux NEDIA E14 ◀ 151 ▶	Kanlux PIXA ◀ 152 ▶	Kanlux HERON II LED ◀ 152 ▶
Kanlux ZARA ◀ 153 ▶	Kanlux SUZI ◀ 153 ▶	Kanlux PRED A LED ◀ 154 ▶	Kanlux REXAR LED ◀ 155 ▶	Kanlux FRANCO II LED ◀ 155 ▶	Kanlux GLOZO DSO ◀ 156 ▶	Kanlux GLOZO DSL ◀ 157 ▶
Kanlux FELINE DSO ◀ 158 ▶	Kanlux FELINE DSL ◀ 159 ▶	Kanlux GOVIK ◀ 160-161 ▶	Kanlux CHIRO GU10 ◀ 162 ▶	Kanlux SPAG ◀ 162 ▶	Kanlux MINI RITI ◀ 163 ▶	Kanlux MINI GORD ◀ 163 ▶
Kanlux MINI BORD ◀ 164 ▶	Kanlux TINY BORD ◀ 164 ▶	Kanlux IMINES ◀ 165 ▶	Kanlux AGEO ◀ 165 ▶	Kanlux APRILA ◀ 165 ▶	Kanlux SEIDY ◀ 166-167 ▶	Kanlux SIMEN DSO ◀ 168 ▶
Kanlux SIMEN DSL ◀ 168 ▶	Kanlux ALOR ◀ 169 ▶	Kanlux ELNIS S ◀ 170 ▶	Kanlux ELNIS L ◀ 170 ▶	Kanlux SOREN ◀ 171 ▶	Kanlux DALLA ◀ 171 ▶	Kanlux ELICEO ◀ 172 ▶

# WOHNRAUM- LEUCHTEN UND DEKORATIVE LEUCHTEN

## DOMESTIC AND DECORATIVE FIXTURES



Kanlux MORTA  
◀ 173 ▶



Kanlux MORTA DT  
◀ 173 ▶



Kanlux MORTA OCT  
◀ 174 ▶



Kanlux MORTA B  
◀ 174 ▶



Kanlux IVRI  
◀ 175 ▶



Kanlux ARET  
◀ 175 ▶



Kanlux ALREN R  
◀ 176 ▶



Kanlux ALREN  
◀ 176 ▶



Kanlux COLIE  
◀ 177 ▶



Kanlux NESTA  
◀ 177 ▶



Kanlux EVIT  
◀ 178 ▶



Kanlux GWEN  
◀ 178 ▶



Kanlux LUTO  
◀ 179 ▶



Kanlux NAVI  
◀ 179 ▶



Kanlux VIDI  
◀ 180 ▶



Kanlux RADAN  
◀ 181 ▶



Kanlux TESON  
◀ 181 ▶



Kanlux HORN  
◀ 181 ▶



Kanlux ARGUS II  
◀ 182-183 ▶



Kanlux TRIBIS II  
◀ 184-185 ▶



Kanlux DROXY IP65  
◀ 186 ▶



Kanlux FLINI IP44  
◀ 186 ▶



Kanlux QULES  
◀ 187 ▶



Kanlux MARIN  
◀ 187 ▶



Kanlux IMBER LED  
◀ 188 ▶



Kanlux ASTIM LED IP44  
◀ 189 ▶

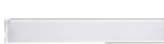

Kanlux ROLSO  
◀ 189 ▶



Kanlux ASTEN LED IP44  
◀ 190-191 ▶



Kanlux AKVO IP44 S  
◀ 192 ▶



Kanlux AKVO IP44  
◀ 193 ▶



Kanlux ERINUS LED  
◀ 194-195 ▶



Kanlux APUS LED  
◀ 196 ▶



Kanlux TERRA LED  
◀ 197 ▶



Kanlux SABIK LED  
◀ 198 ▶



Kanlux SOLA LED  
◀ 199 ▶



Kanlux IRS 3XAAA  
◀ 200 ▶



Kanlux MEFIS LED  
◀ 200 ▶



Kanlux ZEPO  
◀ 202 ▶



Kanlux MERA LED  
◀ 203 ▶



Kanlux HAXA LED  
◀ 204 ▶



Kanlux LINUS LED  
◀ 204 ▶









Kanlux GAVI CT  
◀ 205 ▶



Kanlux GAVI LED  
◀ 205 ▶



**TECHNISCHE  
LEUCHTEN UND ARCHI-  
TEKTURLEUCHTEN**  
TECHNICAL  
AND ARCHITECTURAL  
FIXTURES

						
Kanlux BLINGO LED ◀ 208-209 ▶	Kanlux BLINGO CV ◀ 210-211 ▶	BRAVO LED ◀ 212-213 ▶	Kanlux AVAR LED ◀ 214 ▶	Kanlux REGIS ◀ 216 ▶	Kanlux REGIS 4LED ◀ 217 ▶	Kanlux NOTUS ◀ 218 ▶
						
Kanlux NOTUS 4LED ◀ 219 ▶	Kanlux TP STRONG ◀ 220 ▶	Kanlux TP SLIM LED ◀ 221 ▶	Kanlux TP SLIM TW LED ◀ 221 ▶	Kanlux MAH LED HI ◀ 222 ▶	Kanlux MAH LED N ◀ 223 ▶	Kanlux MAH PLUS 4LED ◀ 224 ▶
						
Kanlux MAH PLUS ◀ 225 ▶	Kanlux MEBA LED IP54 ◀ 226 ▶	Kanlux MEBA 4LED IP54 ◀ 226 ▶	Kanlux MEBA LED ◀ 227 ▶	Kanlux MEBA 4LED ◀ 227 ▶	Kanlux ALDO 4LED ◀ 228-229 ▶	Kanlux IPER LED ◀ 230-231 ▶
						
Kanlux BENO LED ◀ 232-233 ▶	Kanlux VARSO LED ◀ 234-235 ▶	Kanlux STIVI LED ◀ 236 ▶	Kanlux ORTE LED ◀ 237 ▶	Kanlux DABA PRO ◀ 238 ▶	Kanlux DABA N LED SMD ◀ 238 ▶	Kanlux TYBIA LED ◀ 239 ▶
						
Kanlux JURBA DL ◀ 240 ▶	Kanlux PIRES DL ◀ 241 ▶	Kanlux FOGLER LED ◀ 242 ▶	Kanlux FOGLER DL ◀ 242 ▶	Kanlux SANSO LED ◀ 243 ▶	Kanlux MARC DL ◀ 243 ▶	Kanlux ERTON ◀ 244 ▶
						
Kanlux PLAFMIN ◀ 244 ▶	Kanlux HERMI ◀ 245 ▶	Kanlux MILO ◀ 245 ▶	Kanlux INES ◀ 246 ▶	Kanlux SANGA DL ◀ 246 ▶	Kanlux TUNA ◀ 247 ▶	Kanlux TURK ◀ 247 ▶



# TECHNISCHE LEUCHTEN UND ARCHI- TEKTURLEUCHTEN

## TECHNICAL AND ARCHITECTURAL FIXTURES

						
Kanlux HIMA LED ◀ 248-249 ▶	Kanlux TIBERI PRO ◀ 250 ▶	Kanlux TIBERI PRO NT ◀ 251 ▶	Kanlux AREL LED ◀ 252 ▶	Kanlux MATEO ES ◀ 253 ▶	Kanlux IVIAN LED ◀ 253 ▶	Kanlux TAVO LED ◀ 254-255 ▶
						
Kanlux ROUNDA V2LED ◀ 256-257 ▶	Kanlux KATRO V2LED ◀ 258 ▶	Kanlux CARSA V2LED ◀ 260 ▶	Kanlux KANTI V2LED ◀ 261 ▶	Kanlux FL AGOR LED ◀ 262 ▶	Kanlux FL AGOR HI ◀ 263 ▶	Kanlux IQ-LED FL ◀ 264 ▶
						
Kanlux ANTEM LED ◀ 266 ▶	Kanlux STATO LED ◀ 267 ▶	Kanlux FL SONE SLR ◀ 268 ▶	Kanlux FL SOLNAR SLR ◀ 269 ▶	Kanlux STRETON LED ◀ 270 ▶	Kanlux HB PRO LED HI ◀ 272 ▶	Kanlux REKA LED ◀ 274 ▶
						
Kanlux BISO LED ◀ 275 ▶	Kanlux GARTO LED ◀ 275 ▶	Kanlux ZEWE EL ◀ 276 ▶	Kanlux BART EL ◀ 277 ▶	Kanlux LART EL ◀ 277 ▶	Kanlux DULI LED ◀ 278 ▶	Kanlux GLASI LED ◀ 279 ▶
						
Kanlux TAXI SMD ◀ 279 ▶	Kanlux TURRO LED ◀ 280 ▶	Kanlux GORDO N ◀ 281 ▶	Kanlux ROGER DL ◀ 281 ▶	Kanlux BERG AD ◀ 282 ▶	Kanlux BERG DL ◀ 282 ▶	Kanlux XARD DL ◀ 283 ▶
						
Kanlux MORO N ◀ 283 ▶	Kanlux ABETE LED ◀ 285 ▶	Kanlux PEVO ◀ 286 ▶	Kanlux LAVEN ◀ 287 ▶	Kanlux PRESO ◀ 288 ▶	Kanlux SELTO ◀ 289 ▶	Kanlux LIEGO ◀ 290 ▶



**TECHNISCHE LEUCHTEN UND ARCHITEKTURLEUCHTEN**  
 TECHNICAL AND ARCHITECTURAL FIXTURES



Kanlux VIMO  
◀ 291 ▶



Kanlux GORI  
◀ 292 ▶



Kanlux VADRA  
◀ 293 ▶



Kanlux INVO OP  
◀ 294 ▶



Kanlux INVO TR  
◀ 295 ▶



Kanlux STONO N  
◀ 296 - 296 ▶



Kanlux USTI SP  
◀ 298 ▶



Kanlux VORA  
◀ 299 ▶



Kanlux GRIBLO 7 GR  
◀ 300 ▶



Kanlux AKVEN LED  
◀ 300 ▶



Kanlux GRL  
◀ 301 ▶



Kanlux DASTO  
◀ 302 ▶



Kanlux NASTO  
◀ 302 ▶



Kanlux ACORD ATLI  
◀ 304-305 ▶



Kanlux ACORD ATLI2 GU10  
◀ 306 ▶



Kanlux ACORD ATLI3 GU10  
◀ 306 ▶



Kanlux ACORD ATLI4 GU10  
◀ 307 ▶



Kanlux ACORD ATLI5 GU10  
◀ 307 ▶



Kanlux BTL LED  
◀ 308 ▶



Kanlux BTLW LED  
◀ 309 ▶



Kanlux TEAR N  
◀ 310 ▶



Kanlux TEAR N RC  
◀ 311 ▶



Kanlux TEAR N PADAPTOR  
◀ 313 ▶

**SMART ZUBEHÖR** SMART EQUIPMENT



Kanlux SMART  
◀ 316 ▶



Kanlux SMART  
◀ 316 ▶



Kanlux SMART  
◀ 317 ▶



Kanlux SMART  
◀ 318 ▶



Kanlux SMART  
◀ 319 ▶



Kanlux SMART  
◀ 319 ▶



Kanlux SMART  
◀ 319 ▶

**ELEKTROINSTALLATIONSZUBEHÖR**  
 ELECTRICAL INSTALLATION EQUIPMENT



Kanlux SQMOTION  
◀ 322 ▶



Kanlux ALER-N  
◀ 322 ▶



Kanlux ZONA MINI  
◀ 323 ▶



Kanlux ZONA MINI WT  
◀ 323 ▶



Kanlux SENTO-O  
◀ 324 ▶



Kanlux SENSQUARE  
◀ 324 ▶



Kanlux MERGE-WT  
◀ 325 ▶



Kanlux SLICK JQ  
◀ 325 ▶



Kanlux ALER JQ  
◀ 326 ▶



Kanlux ALER MINI  
◀ 326 ▶



Kanlux ZONA JQ-37  
◀ 327 ▶

# ELEKTROINSTALLATIONSZUBEHÖR

## ELECTRICAL INSTALLATION EQUIPMENT



						
Kanlux ZONA ◀ 327 ▶	Kanlux MERGE JQ ◀ 328 ▶	Kanlux MARID JQ ◀ 328 ▶	Kanlux ROLF JQ ◀ 329 ▶			
						
Kanlux ROLF JQ ◀ 329 ▶	Kanlux ROLF JQ ◀ 330 ▶	Kanlux MERGE JQ ◀ 330 ▶	Kanlux MERGE ◀ 331 ▶	Kanlux MERGE ◀ 331 ▶	Kanlux SENTO ◀ 332 ▶	Kanlux SENZO ◀ 332 ▶
						
Kanlux AZ-10A ◀ 333 ▶	Kanlux CYBER ◀ 334 ▶	Kanlux STER TS-MF ◀ 334 ▶	Kanlux ADI ◀ 335 ▶	Kanlux POWELED ◀ 335 ▶	Kanlux CIRCO ◀ 336 ▶	Kanlux DRIVE LED ◀ 336 ▶
						
Kanlux SET ◀ 336 ▶	Kanlux WIR ZL ◀ 337 ▶	Kanlux TWISTER ◀ 337 ▶	Kanlux CYKLON ◀ 338 ▶	Kanlux GRIP ◀ 339 ▶	Kanlux STAN GP ◀ 339 ▶	Kanlux PIN W/US ◀ 339 ▶
						
Kanlux ZARK ◀ 340 ▶	Kanlux APO ◀ 340 ▶	Kanlux BR-GZ10 ◀ 340 ▶	Kanlux HLDR-E14 ◀ 341 ▶	Kanlux HLDR-E14 ◀ 341 ▶	Kanlux HLDR-E27 ◀ 341 ▶	Kanlux HLDR-E27 ◀ 342 ▶
						
Kanlux HLDR-E27 ◀ 342 ▶	Kanlux HLDR-G9 ◀ 342 ▶	Kanlux HLDR-GX5.3 ◀ 343 ▶	Kanlux HLDR-GZ10 ◀ 343 ▶	Kanlux HLDR-R75 ◀ 343 ▶	Kanlux ONTEC S ◀ 344 ▶	Kanlux ONTEC S ◀ 345 ▶
						
Kanlux ITECH ◀ 346 ▶	Kanlux ONTEC G ◀ 347 ▶	Kanlux ONTEC C ◀ 347 ▶	Kanlux ONTEC R ◀ 348 ▶	Kanlux PICTO G ◀ 349 ▶	Kanlux PICTO S ◀ 350 ▶	Kanlux IT ◀ 351 ▶

# ***Kanlux***





*Kanlux*  
**FACTORY**

**LEUCHTEN AUS DER KANLUX-FABRIK**  
KANLUX FACTORY FIXTURES

**Wir können unsere Komplettlösungen  
speziell auf Ihre Bedürfnisse zuschneiden.  
Die Produkte der Kanlux Factory überzeugen  
durch ihre perfekte Passform und die Liebe zum  
Detail. Lernen Sie sie noch heute kennen!**

Our complete solutions can be adjusted  
to your needs. Attention to every detail  
and perfect fit are what characterises  
Kanlux Factory products.  
Discover them today!



*Die photometrischen Daten finden Sie unter:  
photometric data you can find on:*

► [kanlux.com](https://www.kanlux.com)



# ALIN LED

LINEARE LED-LEUCHTE ▶ LINEAR LIGHTING FIXTURES

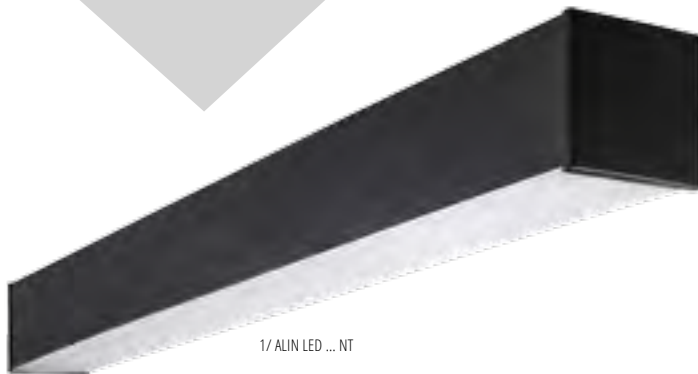

1/ ALIN LED ... NT

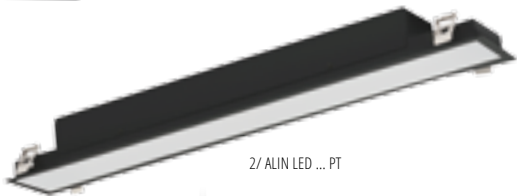

2/ ALIN LED ... PT



3/ ALIN LED ... NT + ALIN CORD + ROPE

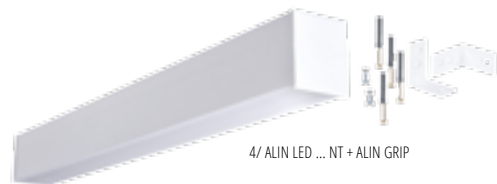

4/ ALIN LED ... NT + ALIN GRIP



5/ ALIN LED ... RM

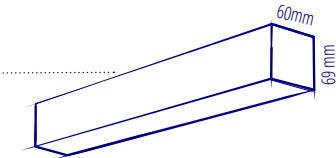

DREI LÄNGEN:  
THREE LENGTHS:  
580MM  
1140MM  
1700MM

FÜNF VERSIONEN  
FIVE VERSIONS

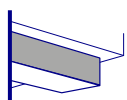

1/ AUFPUTZ  
SURFACE  
MOUNTED

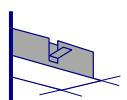

2/ UNTERPUTZ  
RECESSED  
MOUNTED

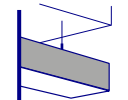

3/ ABHÄNGEND  
SUSPENDED  
MOUNTED

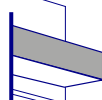

4/ WAND-  
MONTAGE  
WALL  
MOUNTED

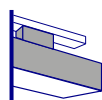

5/ SCHIENEN-  
MONTAGE  
RAIL  
MOUNTED

## WAS UNTERSCHIEDET UNS?

DREI  
GEHÄUSEFARBEN  
THREE  
HOUSING  
COLORS



WEISS  
WHITE

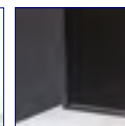

SCHWARZ  
BLACK



SILBER  
SILVER



CONFIGURATOR



Kanlux ALIN LED ist ein Produkt, das mit dem Gedanken an eine ideale Leuchte entstanden ist. Es wurde von Kanlux Designern entworfen, die Innovation mit über 30 Jahren Erfahrung kombiniert haben. Die Markenkomponenten und die präzise Ausführung sorgen für Ästhetik und Langlebigkeit, die sich auf lange Jahre erstreckt. Das breite Angebot an Modellen ermöglicht die Anpassung der Leuchte an jedes Investitionsobjekt.

5 Jahre Garantie auf der Grundlage der Garantieerklärung, die auf der folgenden Internetseite zugänglich ist: [www.kanlux.com](http://www.kanlux.com)

The Kanlux ALIN LED is a product which was created with a view to a perfect fixture. It was created by the Kanlux designers, who combined innovation with 30 years of experience. Their branded components and perfect workmanship ensure the aesthetics and durability of operation for many years. The wide range of models affords the possibility to adjust the fixture to the needs of each investment.

5 years Warranty under the terms of the warranty statement, available on our website: [www.kanlux.com](http://www.kanlux.com)

Wir produzieren für Sie eine ideale Leuchte. Kreieren Sie sie mit Hilfe unseres Konfigurators.

We will produce a perfect luminaire for you. Create it with our configurator.



ZWEI LICHTFARBEN  
UND OPTION MIT  
TUNABLE WHITE  
TWO COLOR  
TEMPERATURES  
AND OPTION WITH  
TUNABLE WHITE

LEGENDE ► KEY

AL	KANLUX ALIN LED
ALD	KANLUX ALIN LED DALI
ALC	CASAMBI READY
S	580mm
M	1140mm
L	1700mm
S	sehr geringe Leistung / super low power
L	niedrige Leistung / low power
M	mittlere Leistung / medium power
H	hohe Leistung / high power
WW	3000K Ra ≥ 80
NW	4000K Ra ≥ 80
TW	tunable white
MAT	Lampenschirm matt / matt lampshade
MPR	mikroprismatischer Lampenschirm / microprismatic lampshade
W	Gehäusefarbe: Weiß / housing colour: white
B	Gehäusefarbe: Schwarz / housing colour: black
S	Gehäusefarbe: Silber / housing colour: silver
NT	Aufputz-Version / surface-mounted
PT	Unterputz-Version / recessed mounted
ALIN +ALIN CORD +ROPE	Abhängend / suspended mounted
ALIN +ALIN NT GRIP	Wandmontage / wall mounted
RM	Schiennenmontage / rail mounted
SE	Ausführung mit Bewegungsmelder / motion sensor
AS	asymmetrisches optisches System / asymmetric optic system



ALLE ARTIKELNUMMERN FINDEN SIE IM KANLUX FACTORY KATALOG / ALL THE CODES OF KANLUX FACTORY FIXTURES YOU CAN FIND IN THE KANLUX FACTORY CATALOGUE



		MAT		MPR	
		WW (830)	NW (840)	WW (830)	NW (840)
SL	10W	1150lm	1300lm	1050lm	1200lm
SH	19W	2250lm	2550lm	2050lm	2350lm
MS	18W	2150lm	2400lm	2050lm	2250lm
ML	25W	2980lm	3250lm	2750lm	3000lm
MM	29W	3450lm	3900lm	3170lm	3600lm
MH	40W	4500lm	5050lm	4150lm	4650lm
LL	33W	4100lm	4550lm	3750lm	4150lm
LH	52W	5600lm	6300lm	5150lm	5800lm

WHAT MAKES US DIFFERENT?

INDIVIDUELLE GEHÄUSEFARBEN  
CUSTOMIZATION OF THE HOUSING COLOR

ZWEI DIFFUSOR-ARTEN  
TWO TYPES OF DIFFUSER

HOCHWERTIGES LED-MODUL  
HIGH QUALITY LED MODULE

MARKENDIODEN UND OSRAM/  
TRIDONIC STROMVERSORUNG  
BRANDED LEDS AND OSRAM/  
TRIDONIC DRIVERS

OPTIONAL DALI-STEUERUNG  
DALI LED DRIVER AVAILABLE AS AN OPTION



# ALIN LED LINE

LINEARE LED-LEUCHTE ▶ LINEAR LIGHTING FIXTURES

# FACTORY



Ein Beleuchtungssystem geschaffen auf der Grundlage perfekt ausgearbeiteter Kanlux ALIN LED-Leuchten. Die Lösung ermöglicht die Erzeugung von langen Lichtlinien in einfachen oder nicht standardisierten Formen. Vollständige Anpassung für eine bestimmte Maßnahme bietet die Möglichkeit um einen einzigartigen Effekt zu erzielen bei jedem Projekt mit Kanlux ALIN LED LINE.

5-Jahres-Garantie gemäß den Bedingungen der Garantieerklärung, verfügbar unter Website: [www.kanlux.com](http://www.kanlux.com)

Kanlux ALIN LED LINE is an innovative lighting system created based on perfectly prepared Kanlux ALIN LED luminaires. This solution allows for creating long light lines with straight or custom shapes. Full adaptation to the specific investment enables creation of a unique effect in each project using Kanlux ALIN LED LINE.

5 years Warranty under the terms of the warranty statement, available on our website: [www.kanlux.com](http://www.kanlux.com)



UNBEGRENZTE LÄNGE VON LICHTLINIEN MIT KOMPLEXEN STRUKTUREN UND FORMEN  
UNLIMITED LENGTH OF LIGHTING LINE WITH COMPLEX STRUCTURES AND SHAPES



ALIN LED LINE IST EIN UNKONVENTIONELLES PROJEKT BASIEREND AUF ELEMENTEN:  
LF/LM/LL  
PROFILVERBINDER: X/T/L  
ANSCHLÜSSE: LTX1/LTX1C/LTX2C/LTX1E  
ALIN LED LINE IS UNCONVENTIONAL PROJECTS BASED ON ELEMENTS: LF/LM/LL  
PASSIVE PROFILE CONNECTORS: X/T/L  
ACTIVE CONNECTORS: LTX1/LTX1C/LTX2C/LTX1E

CONFIGURATOR



Wir produzieren für Sie eine ideale Leuchte. Kreieren Sie sie mit Hilfe unseres Configurators.

We will produce a perfect luminaire for you. Create it with our configurator.

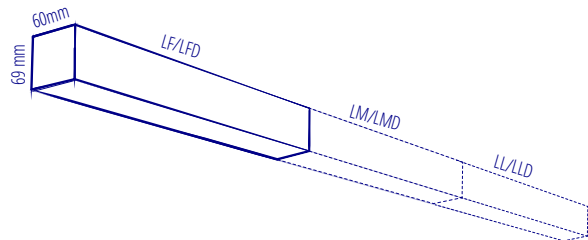
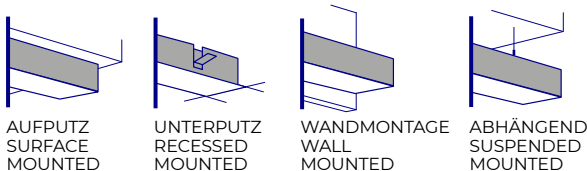

VIER ANSCHLÜSSE:  
FOUR ACTIVE CONNECTORS:  
LTX1  
LTX1C  
LTX2C  
LTX1E

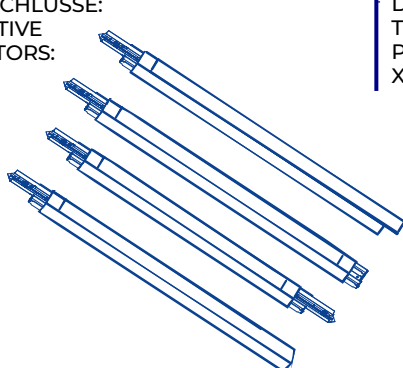

DREI VERBINDER:  
THREE PASSIVE PROFILE:  
X/T/L

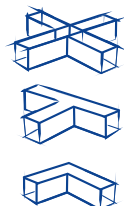

ZWEI LICHTFARBEN UND OPTION MIT TUNABLE WHITE  
TWO COLOR TEMPERATURES AND OPTION WITH TUNABLE WHITE



LEGENDE ► KEY

LF	1137mm Anfangsteil / 1137mm first component
LM	1124mm mittleres Bauteil / 1124mm middle component
LL	1137mm letztes Bauteil / 1137mm last component
LFD	1137mm Anfangsteil DALI / 1137mm first component DALI
LMD	1124mm Mittelteil DALI / 1124mm middle component DALI
LLD	1137mm letzte Komponente DALI / 1137mm last component DALI
L-X, LD-X	X-förmiger Verbinder, DALI / X-shaped connector, DALI type X connector
L-L, LD-L	L-förmiger Verbinder, DALI / L-shaped connector, DALI L type connector
L-T, LD-T	T-förmiger Verbinder, DALI / T-shaped connector, DALI T-connector
LTX1	Verbinder LED: Linien → Verbinder (LTX) / long straight connector → connector (LTX)
LTX1C	Verbinder LED: Linien → Verbinder (LTX) / LTX connector → long straight connector
LTX2C	Verbinder LED: Linien → Verbinder (LTX) / LTX connector → LTX connector
LTX1E	LED-Element, Endverbinder (LTX) / element ending the line behind the LTX connector
S	extrem niedrige Leistung / super low power
L	geringe Leistung / low power
M	mittlere Leistung / medium power
H	hohe Leistung / high power
WW	3000K Ra ≥ 80
NW	4000K Ra ≥ 80
TW	tunable white
MAT	matter Lampenschirm / matt lampshade
MPRM	mikroprismatischer Lampenschirm / microprismatic lampshade
W	Gehäusefarbe: Weiß / housing colour: white
B	Gehäusefarbe: Schwarz / housing colour: black
S	Gehäusefarbe: Silber / housing colour: silver

NT	Aufputzversion / surface-mounted
PT	Unterputz-Version / recessed mounted
ALIN +ALIN NT GRIP	hängend montierte Version / wall mounted
ALIN +CORD +ROPE	Wandmontageversion / suspended mounted

		MAT		MPR	
		WW (830)	NW (840)	WW (830)	NW (840)
MS	18W	2150lm	2400lm	2050lm	2250lm
ML	25W	2980lm	3250lm	2750lm	3000lm
MM	29W	3450lm	3900lm	3170lm	3600lm
MH	40W	4500lm	5050lm	4150lm	4650lm



OPTIONAL DALI-UND  
CASAMBI STEUERUNG  
DALI LED DRIVER AND CASAMBI  
READY AVAILABLE AS AN OPTION

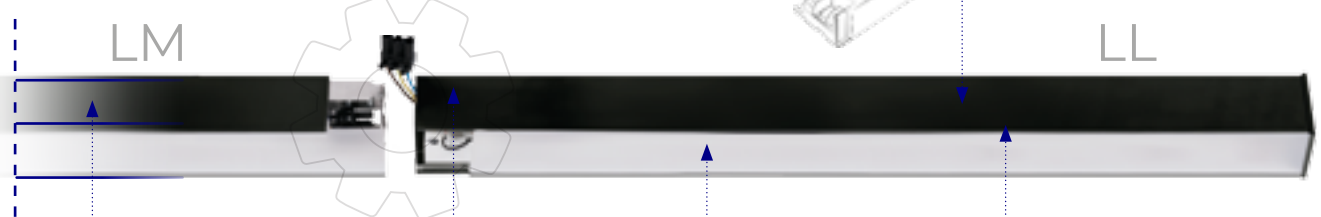

INDIVIDUELLE  
GEHÄUSEFARBEN  
CUSTOMIZATION OF  
THE HOUSING COLOR

DREI  
GEHÄUSEFARBEN  
THREE HOUSING  
COLORS

ZWEI  
DIFFUSOR-ARTEN  
TWO TYPES OF  
DIFFUSER

OPTION MIT EINGEAUTEM,  
UNSICHTBAREN,  
MIKROWELLEN  
BEWEGUNGSMELDER  
OPTION WITH BUILT-IN,  
HIDDEN MICROWAVE  
MOTION SENSOR



WEISS  
WHITE

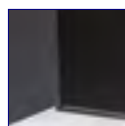

SCHWARZ  
BLACK

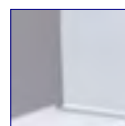

SILBER  
SILVER



MATT  
MATT



MPR  
MIKROPRISMATISCH  
MICROPRISMATIC



Kanlux

# ALIN 4LED

GERADLINIGE LEUCHE FÜR T8 LED-RÖHREN ▶ T8 LED TUBE LINEAR FITTINGS

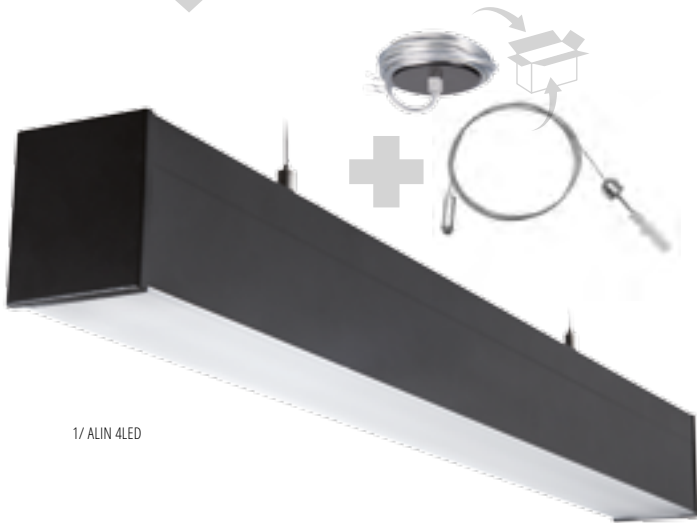

1/ ALIN 4LED

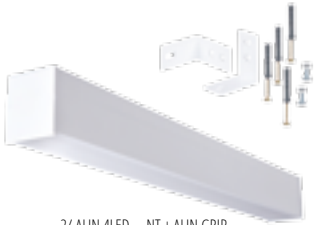

2/ ALIN 4LED ... NT + ALIN GRIP

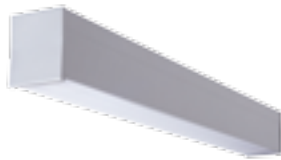

3/ ALIN 4LED ... NT

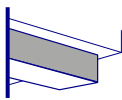

3/ AUFPUTZ  
SURFACE  
MOUNTED

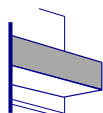

2/ WANDMONTAGE  
WALL  
MOUNTED

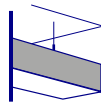

1/ ABHÄNGEND  
SUSPENDED  
MOUNTED

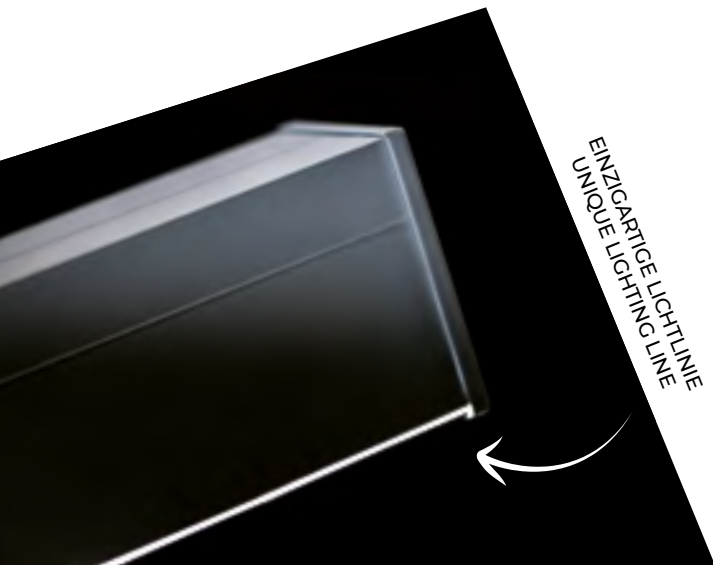

EINZIGARTIGE LICHTLINE  
UNIQUE LIGHTING LINE

# Kanlux FACTORY



Kanlux ALIN 4LED ist eine an die Leuchtstoffröhren T8 LED angepasste Leuchte. Das ist eine Lösung für diejenigen, die eine Lampe mit einem austauschbarem Leuchtmittel schätzen. Die Markenkomponenten und die präzise Ausführung sorgen für Ästhetik und Langlebigkeit, die sich auf lange Jahre erstreckt. Das breite Angebot an Modellen ermöglicht die Anpassung der Leuchte an jedes Investitionsobjekt.



5 Jahre Garantie auf der Grundlage der Garantieerklärung, die auf der folgenden Internetseite zugänglich ist: [www.kanlux.com](http://www.kanlux.com)

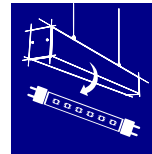

The Kanlux ALIN 4LED is a fixture adapted to T8 LED fluorescent lamps. It is a solution for those who appreciate a replaceable light source. The branded components and perfect workmanship ensure the aesthetics and durability of operation for many years. The wide range of models affords the possibility to adjust the fixture to the needs of each investment.

5 years Warranty under the terms of the warranty statement, available on our website: [www.kanlux.com](http://www.kanlux.com)

CONFIGURATOR



Wir produzieren für Sie eine ideale Leuchte. Kreieren Sie sie mit Hilfe unseres Konfigurators.

We will produce a perfect luminaire for you. Create it with our configurator.



INDIVIDUELLE  
GEHÄUSEFARBEN  
CUSTOMIZATION  
OF THE HOUSING  
COLOR



WAS UNTERSCHIEDET UNS?

DREI LÄNGEN:  
THREE LENGTHS:  
633MM  
1244MM  
1544MM

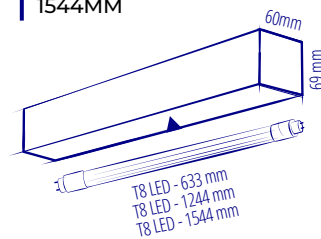

LEGENDE ► KEY

AL 4LED	KANLUX ALIN 4LED
MAT	matt Lampenschirm / matt lampshade
MPR	mikroprismatischer Lampenschirm / microprismatic lampshade
W	Gehäusefarbe: Weiß / housing colour: white
B	Gehäusefarbe: Schwarz / housing colour: black
S	Gehäusefarbe: Silber / housing colour: silver
NT	Aufputz-Version / surface-mounted
ALIN +ALIN NT GRIP	Wandmontage / wall mounted
ALIN +CORD +ROPE	Abhängend / suspended mounted
SE	Version mit Bewegungssensor / motion sensor



ALLE ARTIKELNUMMERN  
FINDEN SIE IM KANLUX  
FACTORY KATALOG  
/ ALL THE CODES OF KANLUX  
FACTORY FIXTURES YOU CAN  
FIND IN THE KANLUX FACTORY  
CATALOGUE



WEISS  
WHITE

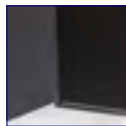

SCHWARZ  
BLACK



SILBER  
SILVER

DREI  
GEHÄUSEFARBEN  
THREE HOUSING  
COLORS

WHAT MAKES US DIFFERENT?

AUSTAUSCHBARE LICHTQUELLE:  
LEUCHTSTOFFLAMPEN  
EMPFOHLEN KANLUX IQ LED  
REPLACEABLE LIGHT  
SOURCE: RECOMMENDED  
IQ LED KANLUX TUBES

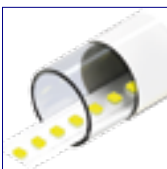

ZWEI DIFFUSORARTEN  
TWO TYPES OF DIFFUSER



MAT  
MATT

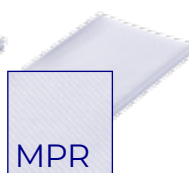

MPR  
MIKROPRISMATISCH  
MICROPRISMATIC

OPTION MIT EINGEBAUTEN,  
UNSICHTBAREN, MIKROWELLEN  
BEWEGUNGSMELDER  
OPTION WITH BUILT-IN, HIDDEN  
MICROWAVE MOTION SENSOR



# ALIN 4LED LINE

GERADLINIGE LEUCHE FÜR T8 LED-RÖHREN ▶ T8 LED TUBE LINEAR FITTINGS

# FACTORY

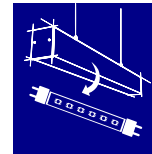

Kanlux ALIN 4LED LINE ist eine absolute Neuheit. Eine einzigartige Lösung, bei der Leuchten mit austauschbaren T8LED-Lichtquellen verwendet werden, um eine modische und funktionelle Lichtlinie zu schaffen. Die unbegrenzte Länge der Linie, das universelle, maßgeschneiderte Design und die Freiheit, die Parameter der Lichtquelle jederzeit zu wählen und zu ändern, geben Ihnen die Möglichkeit, ein einzigartiges, maßgeschneidertes Beleuchtungssystem zu schaffen.

5-Jahres-Garantie gemäß den Bedingungen der Garantieerklärung, verfügbar unter Website: [www.kanlux.com](http://www.kanlux.com)

A unique solution that uses luminaires with replaceable light sources T8LED to create a fashionable and functional light line. Unlimited line length, universal design suited to your needs as well as the freedom to choose and change the parameters of the light source at any time enable the creation of an exceptionally tailored lighting system.

5 years Warranty under the terms of the warranty statement, available on our website: [www.kanlux.com](http://www.kanlux.com)

CONFIGURATOR



Wir produzieren für Sie eine ideale Leuchte. Kreieren Sie sie mit Hilfe unseres Konfigurators.

We will produce a perfect luminaire for you. Create it with our configurator.

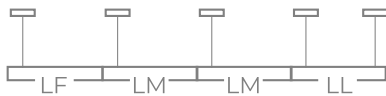

UNBESCHRÄNKTE LÄNGE  
DER BELEUCHTUNGSLINIE  
UNLIMITED LENGTH  
OF LIGHT LINE



KOMBINATIONSMÖGLICHKEIT IN EINER REIHE VON ALIN 4LED-LEUCHTEN MIT EINER LÄNGE VON 1230MM  
POSSIBLE TO COMBINE IN A LINE OF ALIN 4LED LUMINAIRES WITH A LENGTH OF 1230MM

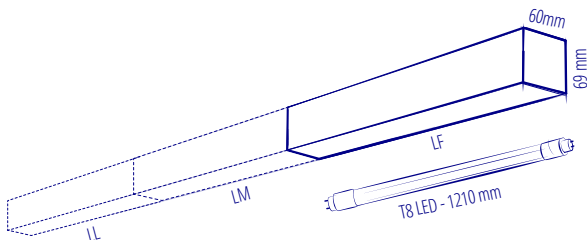
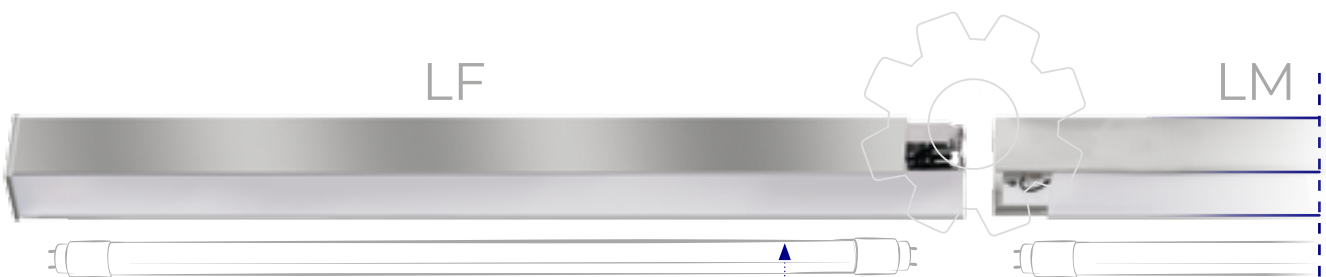
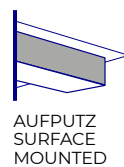

AUSTAUSCHBARE LICHTQUELLE:  
LEUCHTSTOFFLAMPEN  
EMPFOHLEN KANLUX IQ LED  
REPLACEABLE LIGHT  
SOURCE: RECOMMENDED  
IQ LED KANLUX TUBES

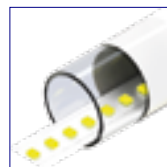

LEGENDE ► KEY

LF	1364mm Anfangsteil / 1364mm first component
LM	1221mm mittlere Komponente / 1221mm middle component
LL	1097mm letztes Bauteil / 1097mm last component
MAT	matter Lampenschirm / matt lampshade
MPRM	mikroprismatischer Lampenschirm / microprismatic lampshade
W	Gehäusefarbe: Weiß / housing colour: white
B	Gehäusefarbe: Schwarz / housing colour: black
S	Gehäusefarbe: Silber / housing colour: silver
NT	Aufputz-Version / surface-mounted
ALIN +CORD +ROPE	Abhängend / suspended mounted
ALIN +ALIN NT GRIP	Wandmontageversion / wall mounted



DREI  
GEHÄUSEFARBEN  
THREE HOUSING  
COLORS



INDIVIDUELLE  
GEHÄUSEFARBEN  
CUSTOMIZATION  
OF THE HOUSING  
COLOR

ZWEI  
DIFFUSOR-ARTEN  
TWO TYPES OF  
DIFFUSER

OPTION MIT EINGEBAUEM,  
UNSICHTBAREM, MIKROWELLEN  
BEWEGUNGSMELDER  
OPTION WITH BUILT-IN, HIDDEN  
MICROWAVE MOTION SENSOR

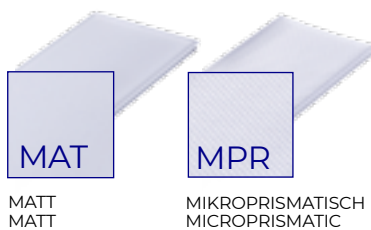



# OFIS S LED

LED-BÜROLEUCHE ▶ LED OFFICE FIXTURE



1/ OFIS S LED ... NT...N4



2/ OFIS S LED ... PT...P1



1/ OFIS S LED ... NT...N3



2/ OFIS S LED ... PT...P3

ABDECKUNGEN IN  
ZWEI FARBEN  
TWO  
VERSIONS

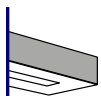

1/ AUFPUTZ  
SURFACE  
MOUNTED



2/ UNTERPUTZ  
RECESSED  
MOUNTED

ZWEI  
GEHÄUSEFARBEN  
TWO HOUSING  
COLORS



WEISS  
WHITE

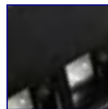

SCHWARZ  
BLACK



DREI  
LICHTFARBEN  
UND OPTION  
MIT TUNABLE  
WHITE  
THREE COLOR  
TEMPERATURES  
AND OPTION  
WITH TUNABLE  
WHITE



Kanlux OFIS S LED ist eine moderne Leuchtenserie, die vor allem für Büroräume geeignet ist. Das schlichte, besonders flache Gehäuse macht die Leuchte sehr elegant, wodurch sie sich perfekt in die Deckenebene einfügt. Die Wahl der Farbe des Leuchtenkörpers, des Diffusors und der Farbtemperatur macht die Leuchte äußerst vielseitig, während das einzigartige Design die Installation so weit wie möglich beschleunigt. Mit einer neuen Generation von Rastern ist es möglich, die Blendwirkung auf ein sehr niedriges Niveau zu reduzieren.

5-Jahres-Garantie gemäß den Bedingungen der Garantieerklärung, verfügbar unter Website: [www.kanlux.com](http://www.kanlux.com)

Kanlux OFIS S LED is a series of modern luminaires intended primarily for office spaces. The simple, extremely flat casing makes the luminaire very elegant so it blends perfectly into the ceiling plane. The possibility of selecting the casing colour, the diffuser and the colour temperature makes it eminently versatile, and the unique design accelerates assembly to the maximum.

5 years Warranty under the terms of the warranty statement, available on our website: [www.kanlux.com](http://www.kanlux.com)

CONFIGURATOR



Wir produzieren für Sie eine ideale Leuchte. Kreieren Sie sie mit Hilfe unseres Konfigurators.

We will produce a perfect luminaire for you. Create it with our configurator.



LEGENDE ► KEY

OS	OFIS S LED
OSD	OFIS S LED DALI
OSC	OFIS S LED CASAMBI READY
40W	Leistung [W] Version MPR / power [W] MPR version
S	extrem niedrige Leistung 22W / super low power 22W
L	geringe Leistung 31W / low power 31W
M	mittlere Leistung 39W / medium power 39W
H	hohe Leistung 49W / high power 49W
5D	optisches System mit 50 Grad Linse / optical system with 50 degree lens
8D	optisches System mit 80 Grad Linse / optical system with 80 degree lens
WW/830	Ra≥80 3000K
WN/835	Ra≥80 3500K
NW/840	Ra≥80 4000K
TW	Ausführung TUNABLE WHITE / TUNABLE WHITE (CCT)
MPRM	mikroprismatischer Diffusor / microprismatic diffuser
RST	Raster / raster
W	Gehäusefarbe: Weiß / housing white
B	Gehäusefarbe: Schwarz / housing black
N1	Aufputz-Version 600x600mm / surface 600x600mm
N3	Aufputz-Version 1200x300mm / surface 1200x300mm
P1	Unterputzversion 595x595mm / recessed 5x9x595mm

P3	Unterputzversion 1195x295mm / recessed 1195x295mm
SE	Version mit Bewegungsmelder / version with the motion sensor
EM	Version mit integrierter Notleuchte / version with built-in emergency module



ALLE ARTIKELNUMMERN FINDEN SIE IM KANLUX FACTORY KATALOG / ALL THE CODES OF KANLUX FACTORY FIXTURES YOU CAN FIND IN THE KANLUX FACTORY CATALOGUE

S/W	3200lm	UGR ≤ 14
S/B	2800lm	UGR ≤ 14
L/W	4300lm	UGR ≤ 15
L/B	3800lm	UGR ≤ 15
M/W	5400lm	UGR ≤ 16
M/B	4800lm	UGR ≤ 16
H/W	6300lm	UGR ≤ 16
H/B	5600lm	UGR ≤ 16

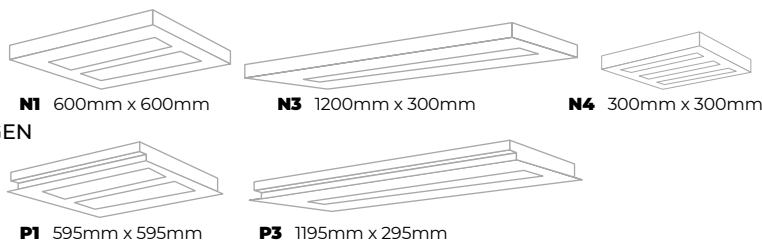

ABMESSUNGEN  
GRÖSSE  
SIZE

ZWEI VERSIONEN DES OPTISCHEN SYSTEMS  
TWO VERSION OF OPTIC SYSTEM

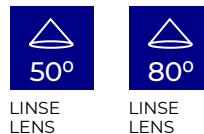

LINSE LENS

LINSE LENS

MARKENDIODEN UND STROMVERSORGUNGEN  
OSRAM/TRIDONIC  
BRANDED LEDS AND  
OSRAM/TRIDONIC DRIVERS



MIKROPRISMATISCH  
MICRO-PRISMATIC



EINE NEUE GENERATION VON RASTERN UM DIE BLENDUNG ZU REDUZIEREN  
A NEW GENERATION OF RASTER TO REDUCE THE GLARE

OPTIONAL DALI-STEUERUNG  
DALI LED DRIVER  
AVAILABLE AS AN OPTION  
AND CASAMBI READY

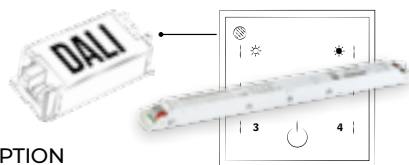

# HIERRO LED

LED-BÜROLEUCHE ▶ LED OFFICE FIXTURE

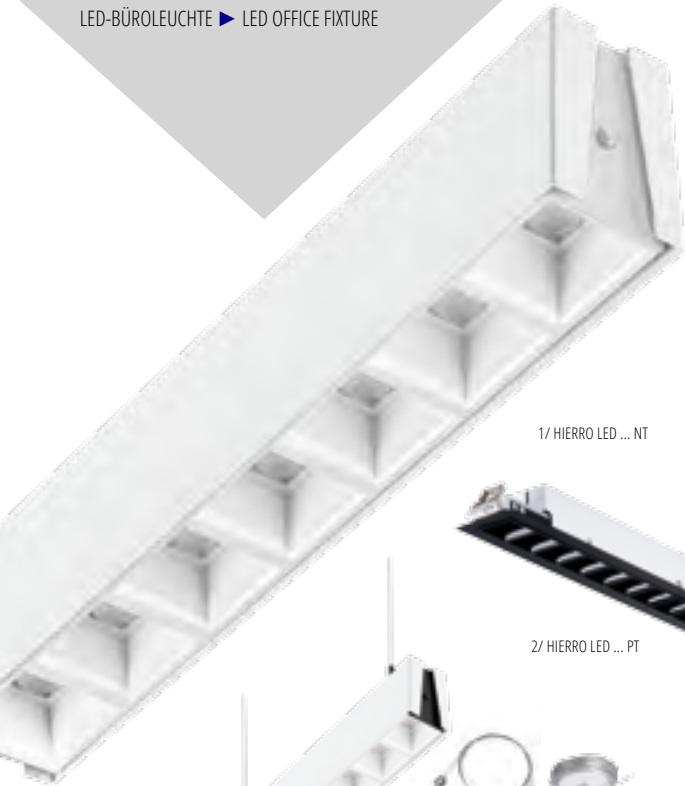

1/ HIERRO LED ... NT



2/ HIERRO LED ... PT



3/ HIERRO LED ... NT + ALIN CORD + ROPE



4/ HIERRO LED ... NTFX



5/ HIERRO LED ... RM  
6/ HIERRO LED ... RMFX

# Kanlux FACTORY



HIERRO ist eine neue Leuchterserie von Büroleuchten im Angebot von Kanlux. Ihre minimalistische und elegante Form folgt den neuesten Trends im architektonischem Design. Die stilvolle Lösung wird häufig in modernen Büros, Geschäften und Lofträumen als Grund-, Zusatz- oder Akzentbeleuchtung verwendet. Das Produktspektrum wird ergänzt durch eine Vielzahl von Steuerungsoptionen. Dies ermöglicht die Realisierung energieeffizienter und fortschrittlicher Beleuchtungssysteme, die für attraktive Lichteffekte sorgen.

5 Jahre Garantie auf der Grundlage der Garantieerklärung, die auf der folgenden Internetseite zugänglich ist: [www.kanlux.com](http://www.kanlux.com)

HIERRO is a new family of luminaires in the Kanlux range. Its minimalist and elegant form follows the latest trends in architectural design. The stylish solution is widely used in modern offices, shops and loft spaces as basic, additional or accent lighting. The product spectrum is made complete with a variety of control options. This makes it possible to implement energy-efficient and advanced lighting systems that provide attractive lighting effects.

5 years Warranty under the terms of the warranty statement, available on our website: [www.kanlux.com](http://www.kanlux.com)

CONFIGURATOR



Wir produzieren für Sie eine ideale Leuchte. Kreieren Sie sie mit Hilfe unseres Konfigurators.

We will produce a perfect luminaire for you. Create it with our configurator.

3 GRÖSSEN  
3 SIZE



**S** 43x65x290mm



**M** 43x65x570mm



**L** 43x65x850mm

6 VERSIONEN  
SIX VERSIONS

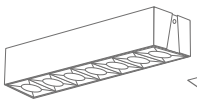

1/ AUFPUTZ  
SURFACE  
MOUNTED

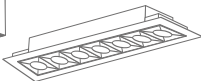

2/ UNTERPUTZ  
RECESSED  
MOUNTED

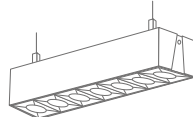

3/ AUFPUTZ MIT SEIL  
SURFACE MOUNTED  
WITH SLINGS

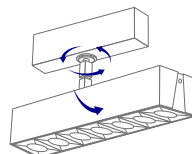

4/ AUFPUTZ FLEX  
340° 90°  
SURFACE MOUNTED  
FLEX 340° 90°

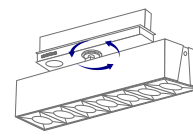

5/ SCHIENENMONTAGE  
STANDARD 340°  
RAIL MOUNTED  
STANDARD 340°

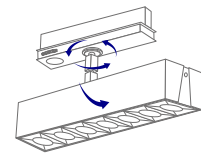

6/ SCHIENENMONTAGE  
FLEX 340° 90°  
RAIL MOUNTED  
340° 90° FLEX



LEGENDE ► KEY

HR	HIERRO LED	
HRD	HIERRO LED DALI	
HRC	HIERRO LED CASAMBI READY	
WW/830	Ra≥80 3000K	
WN/835	Ra≥80 3500K	
NW/840	Ra≥80 4000K	
TW	Ausführung TUNABLE WHITE / TUNABLE WHITE (CCT)	
W	Gehäusefarbe: WEISS / housing white	
B	Gehäusefarbe: SCHWARZ / housing black	
NT	Aufputz-Version / surface	
PT	Unterputz-Version / recessed	
HIERRO +ALIN CORD +ROPE	Abhängend / suspended mounted	
RM	Schienenmontage / rail mounted	
FX/FLEX	zusätzliche Winkelverstellung (auf individuelle Bestellung) / additional angle adjustment (to individual order)	
S	Länge 300mm / length 300mm	
M	Länge 600mm / length 600mm	
L	Länge 900mm / length 900mm	
SL	Parameter / parameters 9W 1250lm 300mm	Version / version NT, PT, RM
SH	Parameter / parameters 14W 1700lm 300mm	Version / version NT, PT, RM
ML	Parameter / parameters 18W 2450lm 600mm	Version / version NT, PT
MM	Parameter / parameters 23W 3000lm 600mm	Version / version NT, PT, RM
MH	Parameter / parameters 28W 3450lm 600mm	Version / version NT, PT, RM
LL	Parameter / parameters 23W 3150lm 900mm	Version / version NT, PT, RM
LM	Parameter / parameters 32W 4200lm 900mm	Version / version NT, PT, RM
LH	Parameter / parameters 42W 5150lm 900mm	Version / version NT, PT, RM



ALLE ARTIKELNUMMERN FINDEN SIE IM KANLUX FACTORY KATALOG / ALL THE CODES OF KANLUX FACTORY FIXTURES YOU CAN FIND IN THE KANLUX FACTORY CATALOGUE

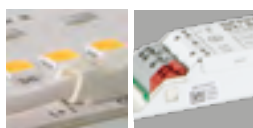

MARKENDIODEN UND OSRAM/TRIDONIC STROMVERSORGUNG  
BRANDED LEDS AND OSRAM/TRIDONIC DRIVERS

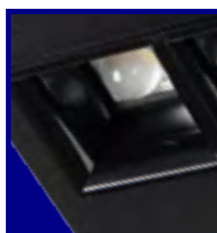

EINE NEUE GENERATION VON RASTERN UM DIE BLENDUNG ZU REDUZIEREN

A NEW GENERATION OF RASTER TO REDUCE THE GLARE

OPTIONAL DALI-UND CASAMBI STEUERUNG / DALI LED AND CASAMBI READY DRIVER AVAILABLE AS AN OPTION



ZWEI GEHÄUSEFARBEN UND MIX VERSIONEN AUF INDIVIDUELLE BESTELLUNG  
TWO HOUSING COLOURS AND MIX VERSIONS TO INDIVIDUAL ORDER



WEISS  
WHITE



SCHWARZ  
BLACK



WEISS/SCHWARZ  
WHITE/BLACK



DREI LICHTFARBEN UND OPTION MIT TUNABLE WHITE  
THREE COLOR TEMPERATURES AND OPTION WITH TUNABLE WHITE

ZWEI VERSIONEN DES OPTISCHEN SYSTEMS  
TWO VERSION OF OPTIC SYSTEM



50°  
LINSE  
LENS



80°  
LINSE ALS INDIVIDUELLE BESTELLUNG / LENS TO INDIVIDUAL ORDER

# FUTURIO LED

STAUBDICHTER LED LEUCHTE ▶ LED DUSTPROOF LIGHTING FITTING



# FACTORY



Kanlux FUTURIO LED ist eine Serie von hermetischen Leuchten, die im Kanlux-Werk hergestellt werden. Sie zeichnen sich durch hohe Verarbeitungsqualität und beeindruckende Parameter aus. Kanlux FUTURIO LED bedeutet auch schnelle und einfache Montage. Eine breite Palette von Modellen bietet die Möglichkeit, die Leuchte an die Bedürfnisse der jeweiligen Investition anzupassen. Es sind auch Sonderausführungen erhältlich: für den Einsatz in hohen Temperaturen oder mit hohen Lichtstrom.

5-Jahres-Garantie gemäß den Bedingungen der Garantieerklärung, verfügbar unter Website: [www.kanlux.com](http://www.kanlux.com)

The Kanlux FUTURIO LED is a series of hermetic fixtures which is produced in the Kanlux factory. They are distinguished by high quality of workmanship and impressive parameters. The Kanlux FUTURIO LED is also quick and easy to install. A wide range of models affords the possibility to adjust the fixture to the needs of each investment. Specialist versions are also available: for high-temperature applications or with high luminous flux.

5 years Warranty under the terms of the warranty statement, available on our website: [www.kanlux.com](http://www.kanlux.com)

CONFIGURATOR



Wir produzieren für Sie eine ideale Leuchte. Kreieren Sie sie mit Hilfe unseres Configurators.

We will produce a perfect luminaire for you. Create it with our configurator.

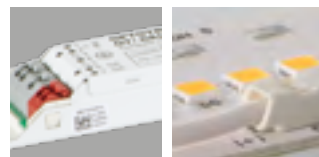

LEDS UND STROMVERSORGUNGEN DER MARKE OSRAM/TRIDONIC  
BRANDED LEDS  
AND OSRAM/TRIDONIC DRIVERS



SCHNELLE INSTALLATION OHNE ÖFFNEN DER LEUCHTE  
EASY MOUNTING WITHOUT THE NECESSITY OF OPENING THE FIXTURE

REGULIERUNGSMÖGLICHKEIT MIT HILFE DER MONTAGEHALTERUNG  
ADJUSTABLE MOUNTING BRACKET



LINIENVERBINDUNG MÖGLICH  
POSSIBILITY OF LINEAR CONNECTION



LEGENDE ► KEY

FT	FUTURIO LED
FTD	FUTURIO LED DALI
FTC	CASAMBI READY
26W - 73W	Leistung[W] / power [W]
840	Ra≥80 4000K
OPL	Opal-Lamellenschirm / opal lamshade
RYF	Lampenschirm mit prismatischer Struktur / prismatic structure lampshade
INT	Linse mit engem Strahlengang / narrow beam angle lens
ASY	asymmetrische Linse für den Abstrahlwinkel / asymmetrical beam angle lens
FTHL	Sonderausführung mit hohen Lumen / special version with high lumen
FTHT	Sonderausführung für den Einsatz bei hohen Temperaturen / special version to work with high temperature
SCF	vereinfachte Option der Korridorfunktion / simple option of the corridor function



ALLE ARTIKELNUMMERN FINDEN SIE IM KANLUX FACTORY KATALOG / ALL THE CODES OF KANLUX FACTORY FIXTURES YOU CAN FIND IN THE KANLUX FACTORY CATALOGUE



ZWEI LÄNGEN  
TWO LENGTHS

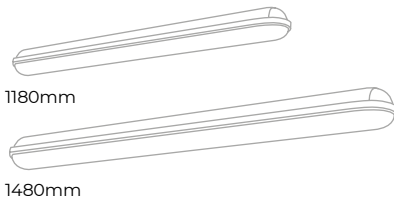

OPTIONALE DALI-STEUERUNG  
DALI LED AND CASAMBI READY DRIVER AVAILABLE AS AN OPTION

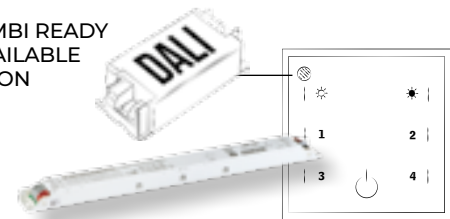

IP 65  
IK 08



ZWEI VERSIONEN MIT LINSEN  
TWO MODELS WITH LENSES

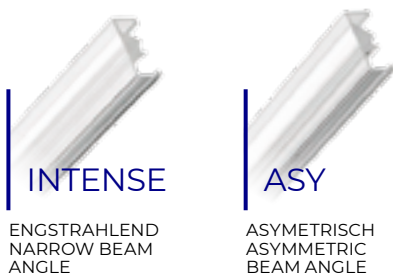

ZWEI ARTEN VON LAMPENSCHIRMEN  
TWO TYPES OF LAMP SHADES

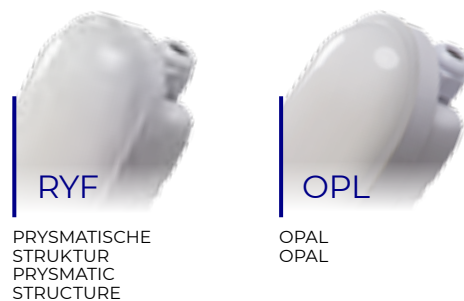

# ADTR

OBERFLÄCHENRAHMEN ► SURFACE-MOUNTED FRAME



Die ADTR-Familie von Universaladaptern ist der schnellste Weg zur Aufbaumontage von Leuchtplatten, z.B. BRAVO, BLINGO. Die monolithische Bauweise, die keine vorherige Verschraubung erfordert, spart Zeit und sorgt jederzeit und unter allen Bedingungen für eine perfekte Optik. Die große Auswahl an Formen und Abmessungen gewährleistet volle Kompatibilität mit 99,9 % der LED-Panel-Lösungen für Kanten und Hintergrundbeleuchtung.

A family of universal ADTR adapters is the fastest way to install surface-mounted lighting panels, e.g. BRAVO, BLINGO. Monolithic design that does not require bolting together beforehand saves time and provides a perfect visual effect every time and under any conditions. Wide range of shapes and sizes ensures full compatibility with 99,9% of LED edge and backlight panel solutions available in the market.

LEGENDE ► KEY

ADTR	Adapter / adapter
ADTR-H	hoher Adapter / high adapter
ADTR-H 76MM	Adapter hoch 76mm / high adapter 76mm
ADTR-S	Adapter SLIM / adapter SLIM
ADTR-S-H	Adapter SLIM hoch 76mm / adapter SLIM high 76mm
W	Gehäusefarbe: Weiß / housing colour: white
B	Gehäusefarbe: Schwarz / housing colour: black
S	Gehäusefarbe: Silber / housing colour: silver

DREI FORMEN  
THREE SHAPES

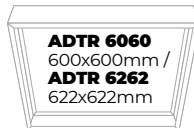

ADTR 12030 B	27614	5905339276148
ADTR 12030 SR	27612	5905339276124
ADTR 12030 W	27611	5905339276117
ADTR 3060 B	29842	5905339298423
ADTR 3060 SR	29841	5905339298416
ADTR 3060 W	29840	5905339298409
ADTR-H 3060 B	33394	5905339333940
ADTR-H 3060 SR	33395	5905339333957
ADTR-H 3060 W	33393	5905339333933
ADTR 6060 B	27615	5905339276155
ADTR 6060 SR	27610	5905339276100
ADTR 6060 W	27613	5905339276131
ADTR 6262 B	33430	5905339334305
ADTR 6262 SR	33431	5905339334312
ADTR 6262 W	33432	5905339334329
ADTR-H 12030 B	33391	5905339333919
ADTR-H 12030 SR	33392	5905339333926
ADTR-H 12030 W	33390	5905339333902
ADTR-H 6060 B	29845	5905339298454
ADTR-H 6060 SR	29844	5905339298447
ADTR-H 6060 W	29843	5905339298430
ADTR-H 6262 B	33433	5905339334336
ADTR-H 6262 SR	33434	5905339334343
ADTR-H 6262 W	33435	5905339334350
ADTR-H 76MM 6060 W	33398	5905339333988
ADTR-H 76MM 6262 B	33437	5905339334374
ADTR-H 76MM 6262 SR	33438	5905339334381
ADTR-H 76MM 6262 W	33436	5905339334367
ADTR-S 6060 W	27616	5905339276162
ADTR-S-H 6060 W	27617	5905339276179



# ADTR

OBERFLÄCHENRAHMEN ► SURFACE-MOUNTED FRAME



DREI HÖHEN  
THREE HEIGHTS



**ADTR**  
Höhe  
45mm /  
height  
45mm



**ADTR-H**  
Höhe  
65mm /  
height  
65mm



**ADTR-H 76MM**  
Höhe  
76mm /  
height  
76mm

DREI  
GEHÄUSEFARBEN  
THREE HOUSING  
COLORS



SCHWARZ  
BLACK



WEISS  
WHITE



SILBER  
SILVER

ÄSTHETISCH GESTALTET  
AESTHETICALLY MADE

KEINE  
ZUSÄTZLICHEN  
ANSCHLÜSSE  
UND KUNSTSTOFF  
ECKKLAMMERN  
NO ADDITIONAL  
CONNECTORS OR  
PLASTIC CORNERS

HOHE STABILITÄT  
UND GARANTIERT  
GENAUE WINKEL  
HIGH STABILITY  
AND GUARANTEED  
CORRECT ANGLES



**Kanlux FACTORY**  
Wir beleuchten Ihr  
Unternehmen

**Kanlux FACTORY**  
Let us light up your  
company





**Kanlux**  
**FACTORY**  
CONFIGURATOR

Wir werden das Licht an  
Ihre Bedürfnisse anpassen  
We will match the light  
with your needs

KONFIGURIEREN SIE IHRE IDEALE LEUCHE  
CONFIGURE THE PERFECT LUMINAIRE ON YOUR OWN



Kanlux **ALIN**



Kanlux **OFIS S**



Kanlux **HIERRO**



Kanlux **FUTURIO**

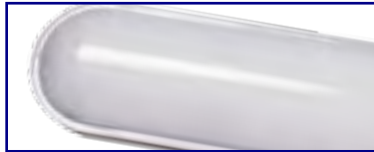

Kanlux **ADTR**



LÄNGE  
LENGTH

LAMPENSCHIRM  
LAMP SHADE

FARBTEMPERATUR  
COLOR TEMPERATURE

LEISTUNG  
POWER

FARBE  
COLOUR

MONTAGEART  
ASSEMBLY

Wir produzieren für Sie eine ideale  
Leuchte. Kreieren Sie sie mit  
Hilfe unseres Konfigurators.

We will produce a perfect  
luminaire for you. Create it  
with our configurator.



# ***Kanlux***





## **LEUCHTMITTEL** LIGHT SOURCES

**Es ist uns wichtig, dass die Produkte in Ihrer Umgebung sicher sind und eine lange Lebensdauer haben. Dafür sorgen wir bei der Produktion und in unserem Kanlux-Labor. Wir sind uns dessen bewusst, dass wir Ihnen ein Produkt anbieten, das vollkommen sicher ist und Ihre Anforderungen erfüllt.**

You want the products around you to be safe and durable. We take care of all of this it during the production and in our Kanlux laboratory. We are sure that we give you a product that is completely safe and meets your requirements.



*Photometrische Daten finden Sie unter:  
photometric data you can find on:*

► [kanlux.com](https://www.kanlux.com)

# KANLUX SMART

LED-LEUCHTMITTEL ▶ LED LIGHT SOURCE



S A60 7W E27 CCT



S A60 9W E27 RGB CCT



Ein modernes Haus ist ein intelligentes und funktionales Haus. Die Leuchtmittel der Serie Kanlux SMART sind so konzipiert, dass sie jedes Haus zu einem solchen machen. Sie können sie über eine mobile Anwendung, über Wi-Fi oder Bluetooth steuern. Die SMART-Lampen von Kanlux verfügen über folgende Funktionen: Dimmen, sanfter Wechsel der Lichtfarbe (CCT) und der Farbe (RGB), die Sie aus einer Palette von 16 Millionen Farben wählen können. Dank Funktionen wie Zeitplan, Biorhythmus oder Gruppierung mit anderen SMART-Geräten werden Sie das Licht zu Hause erfolgreich an Ihren Lebensrhythmus anpassen. Für noch mehr Bedienkomfort können Sie die Kanlux SMART-Lampen mit Sprachbefehlen (Google Assistant / Alexa) steuern.

A modern home is a smart and functional home. The bulbs from the Kanlux SMART series are designed in such a way as to enable the transformation of every home into a modern one. You can control them through a mobile app, via Wi-Fi or Bluetooth. Kanlux SMART bulbs have the following functions: dimming, smooth change of light colour (CCT) and colour (RGB), which you can choose from a palette of 16 million colours. With features such as schedules, biorhythm and grouping with other SMART devices, you can successfully adjust the light in your home to your lifestyle. For even greater comfort of use, you can control Kanlux SMART bulbs by voice command (Google Assistant/Alexa). Learn more about Kanlux SMART on [www.kanluxsmart.com](http://www.kanluxsmart.com)

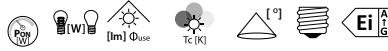

S A60 7W E27 CCT	<b>33640</b>	5905339336408	7	60	806	2700-6500	320	E27	E
S A60 9W E27 RGB CCT	<b>33641</b>	5905339336415	9	60	806	2700-6500	180	E27	F
S A60 11,5W E27 RGB CCT	<b>33642</b>	5905339336422	11,5	75	1055	2700-6500	180	E27	F
S GU10 4,7W RGB CCT	<b>33643</b>	5905339336439	4,7	39	325	2700-6500	110	GU10	G
S C37 4,9W E14 RGB CCT	<b>33644</b>	5905339336446	4,9	40	470	2700-6500	180	E14	F



## Steuerung der Kanlux SMART-Produkte mit der mobilen Anwendung SMART LIFE

Control Kanlux SMART products with the SMART LIFE mobile application

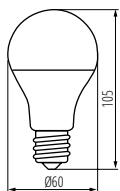

S A60 7W E27 CCT

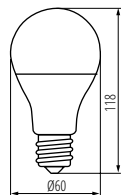

S A60 9W E27 RGB CCT

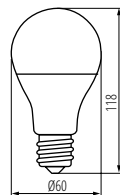

S A60 11,5W E27 RGB CCT

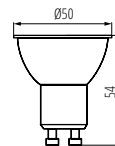

S GU10 4,7W RGB CCT

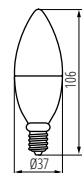

S C37 4,9W E14 RGB CCT

**Kanlux**

# KANLUX SMART

LED-LEUCHTMITTEL ► LED LIGHT SOURCE



S A60 7W E27 CCT



S A60 9W E27 RGB CCT



S A60 11,5WE27 RGB CCT



S GU10 4,7W RGB CCT



S C37 4,9W E14 RGB CCT



**Sie können die Beleuchtung in Ihrem Haus mit Ihrer Stimme steuern. Kanlux SMART-Leuchtmittel arbeiten mit Amazon Alexa und Google Home.**

You can control the lights in your home using your voice. Kanlux SMART sources work with Amazon Alexa and Google Home.

**Funktion „Biorhythm“** | „Biorhythm“ function

**Funktion „Planen - Zeitplan“** | Plan-schedule“ function

**Funktion „Countdown“** | „Countdown“ function

**Intelligente Ereignisverknüpfungsfunktion „Automatisierung/Tap-to-Run“** | Smart event connection function „Automation/Tap-to-Run“

**Funktion „Szenen“** | „Scenes“ function

**Kanlux SMART Leuchtmittel gesteuert über 2,4GHz Wi-Fi und Bluetooth**

Kanlux SMART sources controlled via 2.4GHz Wi-Fi and Bluetooth



[www.kanluxsmart.com](http://www.kanluxsmart.com)

# Kanlux IQ-LED LIFE

LED-LEUCHTMITTEL ▶ LED LIGHT SOURCE



IQ-LED L G45 4,2W



IQ-LED L GU10 4,8W



**5+**  
WARRANTY  
5 years

**LESS**  
blue

**NATURAL &**  
**SAFE** light

**Ra90+**  
true colors

Kanlux IQ-LED LIFE zeichnen sich durch hohe photobiologische Sicherheit, augenfreundliche Farbtemperatur und Zuverlässigkeit aus. Die neuen LIFE-Modelle der bekannten Kanlux IQ-LED-Serie haben vor allem weniger blaues Licht, wodurch die Kanlux IQ-LED LIFE dem natürlichen Licht am nächsten kommen und äußerst sicher und freundlich für Ihre Augen und die Ihrer Lieben sind. Die Kanlux IQ-LED LIFE-Lampen bieten vollen Bedienungskomfort und eine hohe Wiedergabe natürlicher Farben (Ra90) sowie eine fünfjährige Garantie.

5 Jahre Garantie gemäß den Bedingungen der Garantieerklärung, die auf der Website verfügbar ist

Abdeckungsmaterial: Kunststoff

Kanlux IQ-LEDs ensure photobiological safety, have a colour temperature that is beneficial to the eyes and are reliable. The new LIFE models are close to natural light. IQ-LED LIFE products reduce the amount of blue light (LESS BLUE), which affects the mood and well-being of the user, while maintaining the full functionality of the light source. Kanlux IQ-LED LIFE lamps ensure accurate reproduction of natural colours (Ra90) and have a five-year warranty. Kanlux IQ-LED LIFE offers even better quality and comfort of use.

5 years Warranty under the terms of the warranty statement, available on our website  
Lampshade material: plastic

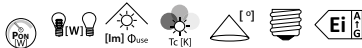

Model	Code	Power [W]	Beam [°]	Temp [K]	Lumen [lm]	Temp [K]	Temp [K]	Temp [K]	Temp [K]	Temp [K]	Temp [K]	Temp [K]
IQ-LED L G45 4,2W-WW	<b>33760</b>	5905339337603	4,2	40	470	2700	240	E14	E			
IQ-LED L G45 4,2W-NW	<b>33761</b>	5905339337610	4,2	41	490	4000	240	E14	E			
IQ-LED L A60 7,2W-WW	<b>33762</b>	5905339337627	7,2	60	806	2700	220	E27	E			
IQ-LED L A60 7,2W-NW	<b>33763</b>	5905339337634	7,2	62	840	4000	220	E27	E			
IQ-LED L GU10 4,8W-WW	<b>33764</b>	5905339337641	4,8	49	450	2700	100	GU10	E			
IQ-LED L GU10 4,8W-NW	<b>33765</b>	5905339337658	4,8	49	450	4000	100	GU10	E			

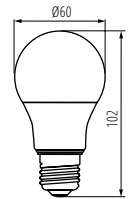

IQ-LED L A60 7,2W

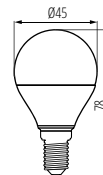

IQ-LED L G45 4,2W

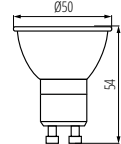

IQ-LED L GU10 4,8W

[V]

220-240 AC

[Hz]

50

SMD

Glare-free  
für MacKadern

Ra  
90

≥40000

25000

Hg

**Kanlux**

# **IQ-LED LIFE**

LED-LEUCHTMITTEL ► LED LIGHT SOURCE



IQ-LED L G45 4,2W



IQ-LED L A60 7,2W



IQ-LED L GU10 4,8W

## **Kanlux macht eine Trendwende und gibt Ihnen eine neue Qualität von Licht!**

Kanlux is making a REVOLUTION and gives you a NEW QUALITY OF LIGHT!



**LESS**  
blue



**Ra90+**  
true colors



**NATURAL &**  
**SAFE light**



**5**  
**WARRANTY**  
5 years





# IQ-LED A60

LED-LEUCHTMITTEL ► LED LIGHT SOURCE



IQ-LED A60 3,4W



IQ-LED A60 5,9W



IQ-LED A60 7,8W



IQ-LED A60 11W

IQ-LED A60 3,4W-WW	36670	5905339366702	3,4	40	470	2700	180	E27	D
IQ-LED A60 3,4W-NW	36671	5905339366719	3,4	40	470	4000	180	E27	D
IQ-LED A60 3,4W-CW	36672	5905339366726	3,4	40	470	6500	180	E27	D
IQ-LED A60 5,9W-WW	36673	5905339366733	5,9	60	806	2700	180	E27	D
IQ-LED A60 5,9W-NW	36674	5905339366740	5,9	60	806	4000	180	E27	D
IQ-LED A60 5,9W-CW	36675	5905339366757	5,9	60	806	6500	180	E27	D
IQ-LED A60 7,8W-WW	36676	5905339366764	7,8	75	1055	2700	180	E27	D
IQ-LED A60 7,8W-NW	36677	5905339366771	7,8	75	1055	4000	180	E27	D
IQ-LED A60 7,8W-CW	36678	5905339366788	7,8	75	1055	6500	180	E27	D
IQ-LED A60 11W-WW	36679	5905339366795	11	100	1521	2700	180	E27	D
IQ-LED A60 11W-NW	36680	5905339366801	11	100	1521	4000	180	E27	D
IQ-LED A60 11W-CW	36681	5905339366818	11	100	1521	6500	180	E27	D

220-240 AC  
 50 Hz  
 SMD  
 360° Use  
 ellipse ≤ 60 MacKam  
 Ra 90  
 ≥50000 h  
 25000 h  
 Hg  
 RoHS  
 CE  
 EAC  
 UK  
 Recycle

**WARRANTY** 3 years  
 **SAFE** light  
 **Ra90+** true colors  
 **QUALITY & COMFORT** of light

Kanlux IQ-LED A60 bietet eine augenfreundliche Farbtemperatur und Zuverlässigkeit, alles im klassischen A60-Design. Die neuen Kanlux IQ-LED-Leuchtmittel zeichnen sich zudem durch eine außergewöhnliche Lichtausbeute von bis zu 138 Lumen pro Watt und damit einen geringeren Energieverbrauch aus. Kanlux IQ-LED sorgt für vollen Bedienkomfort und Sicherheit.

Material: Kunststoff  
Abdeckungsmaterial: Kunststoff

Kanlux IQ-LED A60 provides an eye-friendly temperature of colour and reliability, and all this in the classic A60 design. The new IQ-LED bulbs by Kanlux also offer exceptional luminous efficacy, up to 138 Lumens per Watt, and as a result lower energy consumption. IQ-LEDs from Kanlux offer full comfort and safety.

Material: plastic  
Lampshade material: plastic

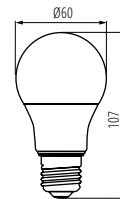

IQ-LED A60 3,4W

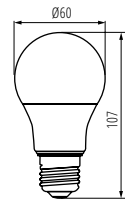

IQ-LED A60 5,9W

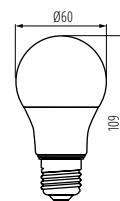

IQ-LED A60 7,8W

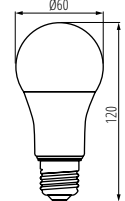

IQ-LED A60 11W



# IQ-LED A67

LED-LEUCHTMITTEL ► LED LIGHT SOURCE



IQ-LED A67 N 19W-WW



IQ-LED A67 N 19W-NW



IQ-LED A67 N 19W-CW



Kanlux IQ-LED steht für photobiologische Sicherheit, augenfreundliche Farbtemperatur und Zuverlässigkeit - all das in der neuen großen A67-Lampe. IQ-LED-Leuchtmittel bieten vollen Nutzungskomfort und Sicherheit, was durch das TÜV Rheinland Zertifikat bestätigt wird.

Material: Kunststoff  
Abdeckungsmaterial: Kunststoff

Kanlux IQ-LED means photo-biological safety, colour temperature friendly to eyes and reliability and all this in a new, large bulb A67. IQ-LED bulbs ensure full comfort of use and safety.

Material: plastic  
Lampshade material: plastic

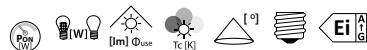

Model	Code	Part No.	Power [W]	Current [A]	Voltage [V]	Temp [K]	Beam [°]	Base	Class
IQ-LED A67 N 19W-WW	33746	5905339337467	19	150	2452	2700	200	E27	E
IQ-LED A67 N 19W-NW	33747	5905339337474	19	150	2452	4000	200	E27	E
IQ-LED A67 N 19W-CW	33748	5905339337481	19	150	2452	6500	200	E27	E

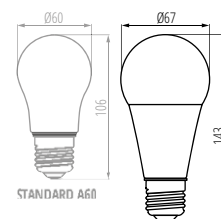

IQ-LED A67 N 19W

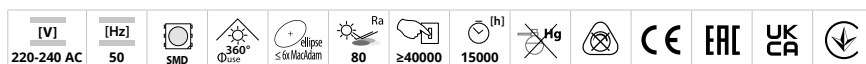

# IQ-LEDDIM A60

LED-LEUCHTMITTEL ► LED LIGHT SOURCE



IQ-LEDDIM A60 7,3W



IQ-LEDDIM A60 10,5W



IQ-LEDDIM A60 13,6W

			P <sub>in</sub> [W]	ϕ [mm]	h [mm]	lm	θ <sub>use</sub> [°]	TC [K]	γ [°]	ELV	Ei A G
IQ-LEDDIM A60 7,3W-WW	<b>33722</b>	5905339337221	7,3	60	806	2700	220	E27	E		
IQ-LEDDIM A60 7,3W-NW	<b>33723</b>	5905339337238	7,3	60	806	4000	220	E27	E		
IQ-LEDDIM A60 10,5W-WW	<b>33724</b>	5905339337245	10,5	75	1060	2700	220	E27	F		
IQ-LEDDIM A60 10,5W-NW	<b>33725</b>	5905339337252	10,5	75	1060	4000	220	E27	F		
IQ-LEDDIM A60 13,6W-WW	<b>33726</b>	5905339337269	13,6	100	1521	2700	220	E27	E		
IQ-LEDDIM A60 13,6W-NW	<b>33727</b>	5905339337276	13,6	100	1521	4000	220	E27	E		

[V]	[Hz]	SMD	360° ϕ <sub>use</sub>	dim ≤ 60 MacKam	Ra	≥40000	[h]	Hg		CE	ERC	UK	
220-240 AC	50			80	25000								



**WARRANTY**  
3 years

**DIMMING**  
FUNCTION

**SAFE**  
light

**QUALITY & COMFORT**  
of light

Kanlux IQ-LED steht für photobiologische Sicherheit, augenfreundliche Farbtemperatur und Zuverlässigkeit. Jetzt ist all das in der neuen Version mit dem E27-Sockel erhältlich - zusätzlich funktioniert die IQ-LEDDIM-Version mit Dimmern. IQ-LED-Leuchtmittel bieten vollen Nutzungskomfort und Sicherheit, was durch das TÜV Rheinland Zertifikat bestätigt wird.

Material: Kunststoff  
Abdeckungsmaterial: Kunststoff

Kanlux IQ-LED means photo-biological safety, colour temperature friendly to eyes and reliability. Now, all this in a new version with E27 light bulb base - additionally, the IQ-LEDDIM version cooperates with dimmers. IQ-LED bulbs ensure full comfort of use and safety.

Material: plastic  
Lampshade material: plastic

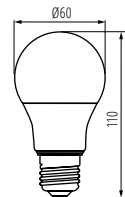

IQ-LEDDIM A60 7,3W; IQ-LEDDIM A60 10,5W

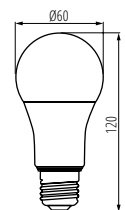

IQ-LEDDIM A60 13,6W

# XLED EX A60

LED-LEUCHTMITTEL ▶ LED LIGHT SOURCE

NEW



XLED EX A60 4W



XLED EX A60 5W



XLED EX A60 7,2W



Die nächste Ausgabe der EXTREM effizienten Lichtquellen Kanlux XLED EX A60 v2. Die überdurchschnittliche Lichtausbeute von 210 Lumen pro Watt macht diese LED-Lampen 15-mal effizienter als ihre herkömmlichen Standard-Vorgänger. 5 Jahre Garantie, 50.000 Stunden Haltbarkeit, 50.000 Ein-/Ausschaltzyklen sind weitere Vorteile. Darüber hinaus verfügen sie über einen Glaskolben und Glühfaden-„Stäbe“, die Wolframlampen ähneln, jedoch die neuesten Errungenschaften der LED-Technologie nutzen.

5 Jahre Garantie gemäß den Bedingungen der Garantieerklärung, die auf der Website verfügbar ist

Abdeckungsmaterial: Glas

The next edition of EXTREMELY efficient light sources Kanlux XLED EX A60. The above-average luminous efficiency of 210 lumens per watt makes these LED bulbs 15 times more efficient than their traditional, standard predecessors. 5-year warranty, 50,000 hours of durability, 50,000 on/off cycles are their other advantages. In addition, they have a glass bulb and filament "rods" that resemble tungsten bulbs, but use the latest achievements of LED technology.

5 years Warranty under the terms of the warranty statement, available on our website  
Lampshade material: glass



Model	Code	Part No.	Power (W)	Beam Angle (°)	Lumen (lm)	Beam Diameter (mm)	Height (mm)	Base	Energy Class
XLED EX A60 4W-WW	36243	5905339362438	4	62	840	2700	320	E27	A
XLED EX A60 4W-NW	36244	5905339362445	4	62	840	4000	320	E27	A
XLED EX A60 5W-WW	36245	5905339362452	5	75	1055	2700	320	E27	A
XLED EX A60 5W-NW	36246	5905339362469	5	75	1055	4000	320	E27	A
XLED EX A60 7,2W-WW	36247	5905339362476	7,2	100	1521	2700	320	E27	A
XLED EX A60 7,2W-NW	36248	5905339362483	7,2	100	1521	4000	320	E27	A

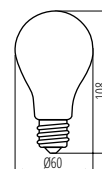

XLED EX A60



# XLED A60

LED-LEUCHTMITTEL ▶ LED LIGHT SOURCE



XLED A60 4,5W



XLED A60 7W



XLED A60 8W, 10W



Kanlux XLED kombiniert die besten Eigenschaften einer herkömmlichen Glühlampe und modernen LED-Leuchtmitteln. Deshalb nennen wir sie das erste echte „LED-LEUCHTMITTEL“. Ein Glaskörper in Form einer herkömmlichen Glühlampe und LEDs, die so angeordnet sind, dass sich das Licht in alle Richtungen ausbreitet und der Ausstrahlungswinkel sogar bis zu 320 Grad beträgt!

Abdeckungsmaterial: Glas

Kanlux XLED combines the best features of traditional bulbs and modern LED light sources. Therefore, we talk about it as the first real LED bulb. A glass bulb in the shape of a traditional bulb and LED diodes placed in such a way so that light can part in all directions, and the angle of light comes to even 320 degrees!

Lampshade material: glass



Model	Power (W)	Voltage (V)	Power factor (PF)	Beam angle (°)	Filament	Lifetime (h)	Energy efficiency class (Ei)	ENEC
XLED A60 4,5W-WW	29600	5905339296009	4,5	40	470	2700	320	E27 15000 F
XLED A60 7W-WW	29601	5905339296016	7	60	810	2700	320	E27 15000 E
XLED A60 7W-NW	29602	5905339296023	7	60	810	4000	320	E27 15000 E
XLED A60 7W-CW	29603	5905339296030	7	60	810	6500	320	E27 15000 E
XLED A60 8W-WW	29604	5905339296047	8	75	1055	2700	320	E27 15000 E
XLED A60 10W-WW	29605	5905339296054	10	99	1520	2700	320	E27 10000 D
XLED A60 10W-NW	29606	5905339296061	10	99	1520	4000	320	E27 10000 D

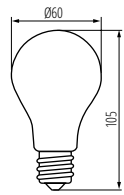

XLED A60 4,5W; XLED A60 7W; XLED A60 8W; XLED A60 10W



**Kanlux**

# XLED A70

LED-LEUCHTMITTEL ► LED LIGHT SOURCE



XLED A70 18W



Kanlux XLED kombiniert die besten Eigenschaften einer herkömmlichen Glühlampe und moderner LED-Leuchtmittel. Deshalb nennen wir sie das erste echte „LED-LEUCHTMITTEL“. Ein Glaskörper in Form einer traditionellen „Birne“ und LEDs, die so angeordnet sind, dass sich das Licht in alle Richtungen ausbreitet.

Abdeckungsmaterial: Glas

Kanlux XLED combines the best features of traditional bulbs and modern LED light sources. Therefore, we talk about it as the first real “LED bulb”. A70 glass bulb has extraordinary size in the shape of a traditional bulb and LED diodes are arranged inside in such a way so that light can part in all directions.

Lampshade material: glass

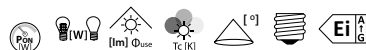

XLED A70 18W-WW	<b>29648</b>	5905339296481	18	149	2450	2700	320	E27	D
XLED A70 18W-NW	<b>29649</b>	5905339296498	18	149	2450	4000	320	E27	D

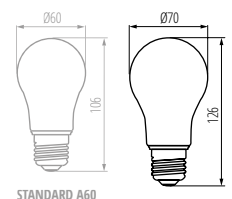

STANDARD A60

XLED A70 18W



# XLED A60M

LED-LEUCHTMITTEL ▶ LED LIGHT SOURCE



XLED A60M 4,5W, XLED A60M 7W,  
XLED A60M 8W, XLED A60M 10W



Kanlux XLED kombiniert die besten Eigenschaften einer herkömmlichen Glühlampe und modernen LED-Leuchtmitteln. Deshalb nennen wir sie das erste echte „LED-LEUCHTMITTEL“. Ein Glaskörper in Form einer herkömmlichen Glühlampe und LEDs, die so angeordnet sind, dass sich das Licht in alle Richtungen ausbreitet und der Ausstrahlungswinkel sogar bis zu 320 Grad beträgt!

Abdeckungsmaterial: Glas

Kanlux XLED combines the best features of traditional bulbs and modern LED light sources. A matt bulb in the shape of a traditional bulb and LED diodes placed in such a way so that light can part in all directions, and the angle of light comes to even 320 degrees!

Lampshade material: glass



	Power (W)	Voltage (V)	Beam angle (°)	Color temperature (K)	Beam diameter (mm)	Base type	Lifetime (h)	Energy efficiency class
XLED A60 4,5W-WW-M	29607	5905339296078	4,5	40	470	2700	320	E27 15000 F
XLED A60 4,5W-NW-M	29608	5905339296085	4,5	40	470	4000	320	E27 15000 F
XLED A60 7W-WW-M	29609	5905339296092	7	60	810	2700	320	E27 15000 E
XLED A60 7W-NW-M	29610	5905339296108	7	60	810	4000	320	E27 15000 E
XLED A60 8W-WW-M	29612	5905339296122	8	75	1055	2700	320	E27 15000 E
XLED A60 8W-NW-M	29613	5905339296139	8	75	1055	4000	320	E27 15000 E
XLED A60 10W-WW-M	29615	5905339296153	10	99	1520	2700	320	E27 10000 D
XLED A60 10W-NW-M	29616	5905339296160	10	99	1520	4000	320	E27 10000 D

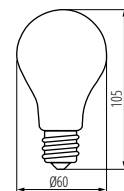

XLED A60M 4,5W, XLED A60M 7W,  
XLED A60M 8W, XLED A60M 10W

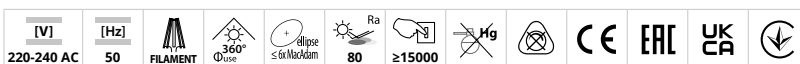

Kanlux

# XLED STEPDIM

LED-LEUCHTMITTEL ► LED LIGHT SOURCE



XLED A60 7W-STEPDIM



XLEDA60 7W-WW-STEPDIM	<b>29634</b>	5905339296344	max 7	60	max 810	2700	320	E27	E
XLEDA60 7W-NW-STEPDIM	<b>29635</b>	5905339296351	max 7	60	max 810	4000	320	E27	E

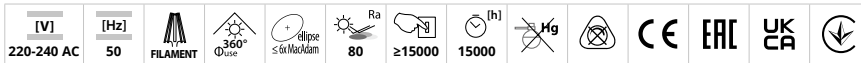

**STEP DIMMING** function

- 1x CLICK 100% power
- 2x CLICK 50% power
- 3x CLICK 7% power
- 2x CLICK + RESET 100% power
- <0,5s



Kanlux XLED kombiniert die besten Eigenschaften einer herkömmlichen Glühlampe und modernen LED-Leuchtmitteln. Deshalb nennen wir sie das erste echte „LED-LEUCHTMITTEL“. Ein Glaskörper in Form einer herkömmlichen Glühlampe und LEDs, die so angeordnet sind, dass sich das Licht in alle Richtungen ausbreitet. Darüber hinaus können wir den Lichtstrom in der STEPDIM-Version ohne zusätzlichen Dimmer schrittweise reduzieren.

Abdeckungsmaterial: Glas

Kanlux XLED combines the best features of traditional bulbs and modern LED light sources. Therefore, we talk about it as the first real LED bulb. A glass bulb in the shape of a traditional bulb and LED diodes placed in such a way so that light can part in all directions. Additionally, in the STEPDIM version you can gradually reduce the light stream without an additional dimmer.

Lampshade material: glass

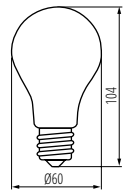

XLED A60 7W-STEPDIM

Kanlux

# XLEDIM A60

LED-LEUCHTMITTEL ► LED LIGHT SOURCE



XLEDIM A60 E27 11W

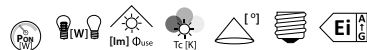

XLEDIM A60 E27 11W-WW	<b>37240</b>	5905339372406	11	100	1521	2700	320	E27	D
XLEDIM A60 E27 11W-NW	<b>37241</b>	5905339372413	11	100	1521	4000	320	E27	D
XLEDIM A60 E27 11W-CW	<b>37242</b>	5905339372420	11	100	1521	6500	320	E27	D

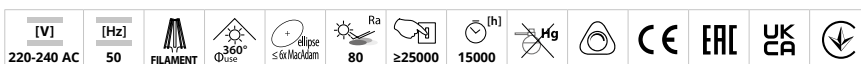

Kanlux XLEDIM A60 11W LED-Leuchtmittel bieten das gleiche Licht wie traditionelle 100-W-Glühbirnen (1520lm) und sind dimmbar. Sie vereinen das traditionelle Glühbirnen-Design mit modernster LED-Technik. Außerdem gewährleisten sie vollen Nutzungskomfort und Sicherheit, was durch Tests in unserem Kanlux-Labor bestätigt wird.

Abdeckungsmaterial: Glas

Kanlux XLEDIM A60 has high light output in a traditional bulb shape. Additionally, Kanlux XLEDIM A60 is a decorative filament that will look great in outdoor lamps. Kanlux XLEDIM A60 11W bulbs provide light equivalent to traditional 100W bulbs (1520lm) and work with dimmers. Moreover, they ensure full comfort of use and safety, which is confirmed by tests at the Kanlux Laboratory.

Lampshade material: glass

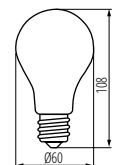

XLEDIM A60 E27 11W



# XLED A60 B22

LED-LEUCHTMITTEL ► LED LIGHT SOURCE



XLED A60 B22



XLED A60M B22-M

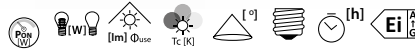

Model	Power [W]	Part No.	Power [W]	Beam Angle [°]	Beam Spread [mm]	Temp. [K]	Beam Spread [mm]	Temp. [K]	Life [h]	Energy Class
XLED A60 B22 7W-WW	33100	5905339331007	7	60	810	2700	320	B22	15000	E
XLED A60 B22 7W-WW-M	33102	5905339331021	7	60	810	2700	320	B22	15000	E
XLED A60 B22 7W-CW-M	33103	5905339331038	7	60	810	6500	320	B22	15000	E
XLED A60 B22 10W-WW-M	33108	5905339331083	10	99	1520	2700	320	B22	10000	D
XLED A60 B22 10W-CW-M	33109	5905339331090	10	99	1520	6500	320	B22	10000	D

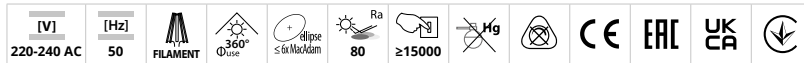

Kanlux XLED A60 B22 M kombiniert die besten Eigenschaften einer herkömmlichen Glühlampe und modernen LED-Leuchtmitteln. Deshalb nennen wir sie die erste echte „LED-Lampe“. Ein Glaskörper in Form einer herkömmlichen Glühlampe und LEDs, die so angeordnet sind, dass sich das Licht in alle Richtungen ausbreitet, und der Ausstrahlungswinkel sogar bis zu 320 Grad beträgt! Die XLED A60 haben ein B22 Sockel.

Abdeckungsmaterial: Glas

Kanlux XLED A60 B22 M combines the best features of traditional light bulbs and modern LED light sources. Matte bulb in the shape of a traditional light bulb and LED diodes arranged in such a way that the light spreads in all directions, and the beam angle is even 320 degrees! XLED A60 B22 M bulbs have a B22 cap.

Lampshade material: glass

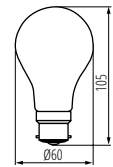

XLED A60 B22

# XLEDIM A60 B22

LED-LEUCHTMITTEL ► LED LIGHT SOURCE



XLEDIM A60 B22 12W



Model	Power [W]	Part No.	Power [W]	Beam Angle [°]	Beam Spread [mm]	Temp. [K]	Beam Spread [mm]	Temp. [K]	Life [h]	Energy Class
XLEDIM A60 B22 12W-WW	37243	5905339372437	12	100	1521	2700	320	B22	E	
XLEDIM A60 B22 12W-CW	37244	5905339372444	12	100	1521	6500	320	B22	E	

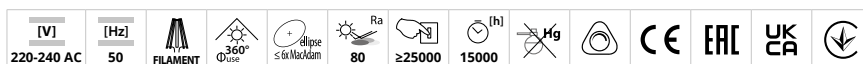

Kanlux XLEDIM A60 B22 LED-Leuchtmittel bieten das gleiche Licht wie traditionelle 100-W-Glühbirnen (1520lm) und sind dimmbar. Diese Leuchtmittel haben einen B22-Sockel. Sie vereinen das traditionelle Glühbirnen-Design mit modernster LED-Technik. Außerdem gewährleisten sie vollen Nutzungskomfort und Sicherheit, was durch Tests in unserem Kanlux-Labor bestätigt wird.

Abdeckungsmaterial: Glas

Kanlux XLEDIM A60 B22 is high luminous power enclosed in a traditional bulb shape. In addition, Kanlux XLEDIM A60 is a decorative filament that will look wonderful in exposed lamps. Kanlux XLEDIM A60 bulbs of 11W produce light equivalent to traditional 100W incandescent bulbs (1520lm) and are compatible with dimmers. Sources marked B22 are fitted with a B22 cap.

Lampshade material: glass

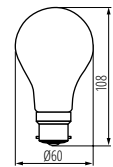

XLEDIM A60 B22 12W

# RAPIDv2 LED

LED-LEUCHTMITTEL ▶ LED LIGHT SOURCE



RAPID v2 E27



RAPID PRO v2 E27



RAPID MAXX v2 E27



RAPID HI v2 E27



Die Kanlux RAPID E27 sind mit großer Präzision und Sorgfalt hergestellt. Ihre Versionen Kanlux RAPID HI erreichen sehr hohe Leistungen (Äquivalente von traditionellen 100-W-Glühlampen). Sie zeichnen sich vor allem durch hohe Lichtstromstärke und Lichtausbeute von fast 117 lm/W aus. Ein weiterer Vorteil dieses Leuchtmittel ist der hybride Gehäusebau.

Material: Kunststoff  
Abdeckungsmaterial: Kunststoff

Kanlux RAPIDv2 E27 sources were made with the highest attention to every detail. They are distinguished by high luminous flux and luminous efficiency reaching almost 117 lm/W (RAPID HI). An additional advantage of these LED lamps is the hybrid housing design.

Material: plastic  
Lampshade material: plastic

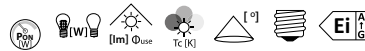

RAPID v2 E27-NW	<b>22944</b>	5905339229441	4,9	41	500	4000	180	E27	F
RAPID v2 E27-WW	<b>22945</b>	5905339229458	4,9	41	500	3000	180	E27	F
RAPID PRO v2 E27-NW	<b>22946</b>	5905339229465	8	60	810	4000	180	E27	F
RAPID PRO v2 E27-WW	<b>22947</b>	5905339229472	8	60	810	3000	180	E27	F
RAPID MAXX v2 E27-NW	<b>22948</b>	5905339229489	9,5	74	1050	4000	180	E27	E
RAPID MAXX v2 E27-WW	<b>22949</b>	5905339229496	9,5	74	1050	3000	180	E27	E
RAPID HI v2 E27-NW	<b>22954</b>	5905339229540	13	99	1520	4000	180	E27	E
RAPID HI v2 E27-WW	<b>22955</b>	5905339229557	13	99	1520	3000	180	E27	E

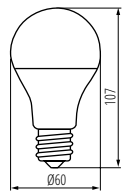

RAPID v2 E27; RAPID PRO v2 E27

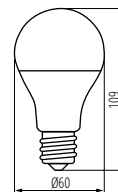

RAPID MAXX v2 E27

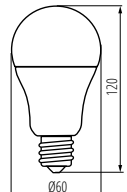

RAPID HI v2 E27



# ST45 LED

LED-LEUCHTMITTEL ▶ LED LIGHT SOURCE



ST45 LED 0,5W



NEW

ST45 LED 0,9W E27-RE



NEW

ST45 LED 0,9W E27-GR



NEW

ST45 LED 0,9W E27-BL



Kanlux ST45 LED ist eine Lichtquelle, deren Leuchtmittel aus Kunststoff besteht, was eine außergewöhnliche Bruchsicherheit im Außenbereich gewährleistet. Sie ist eine hervorragende Ergänzung für jede Lichtgirlande, funktioniert aber auch gut in Gartenleuchten wie Kanlux VIMO oder Kanlux SELTO. Die ST45-LEDs haben einen E27-Sockel und sind äußerst sparsam im Verbrauch - ihre Wattzahl beträgt 0,5 W. Sie können traditionelle Glühbirnen in natürlichen oder warmen Farben wählen oder sich für die farbige Version (RE-rot, GR-grün, BL-blau).

Abdeckungsmaterial: Kunststoff

Kanlux ST45 LED is a plastic bulb that provides exceptional resistance to breakage in outdoor conditions. It is the perfect accessory for a light garland, but will also work well with garden luminaires such as Kanlux VIMO, for example, and for lighting verandas, terraces, garden gazebos or restaurant gardens. ST45 LEDs have an E27 cap and are outstandingly economical in use. They come in warm white and neutral white, as well as a few selected colours (red, green, blue).

Lampshade material: plastic



ST45 LED 0,5W E27-WW	<b>26045</b>	5905339260451	0,5	50	warmweiß   Warm white	220	E27
ST45 LED 0,5W E27-NW	<b>26046</b>	5905339260468	0,5	50	weiß   white	220	E27
ST45 LED 0,9W E27-BL	<b>26039</b>	5905339260390	0,9	8	blau   blue	220	E27
ST45 LED 0,9W E27-GR	<b>26048</b>	5905339260482	0,9	75	grün   green	220	E27
ST45 LED 0,9W E27-RE	<b>26049</b>	5905339260499	0,9	20	rot   red	220	E27

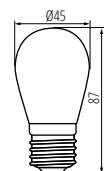

ST45 LED E27

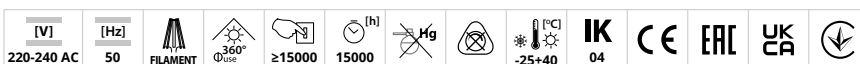

# Kanlux ST64 A

LED-LEUCHTMITTEL ► LED LIGHT SOURCE



ST64 A 4W-SW



DECO  
RI  
function

1800K  
SUPER  
WARM

unique  
LIGHT  
effect

Kanlux ST64 A ist eine äußerst dekoratives LED-Leuchtmittel mit einer sehr warmen Lichtfarbe (1800K). Der „LED-Faden“ und das Braunglas, aber auch der Ring an der Kappe dieser Lichtquelle sind dekorativ. Dies schafft eine warme, erholsame Atmosphäre.

Abdeckungsmaterial: Glas

Kanlux ST64 A is an exceptionally decorative LED bulb with a very warm light color (1800K). The decorative value is both the "LED filament" and amber glass, but also the ring itself at the base of this light source. With its help, we will create a warm atmosphere conducive to relaxation.

Lampshade material: glass



ST64 A 4W-SW	26047	5905339260475	4	20	200	1800	E27
--------------	-------	---------------	---	----	-----	------	-----

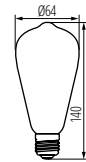

ST64 A 4W-SW

[V]	[Hz]	FILAMENT	360° Φuse	Ra	≥15000	[h]	25000	Hg	CE	EAC	UK CA	↓
220-240 AC	50			80								

# Kanlux XLED ST64

LED-LEUCHTMITTEL ► LED LIGHT SOURCE



XLED ST64-7W



XLED ST64C 7W



320°

HIGH  
lumen

FILAMENT  
LED

Kanlux XLED ST64 vereint die besten Eigenschaften von traditionellen Glühlampen und modernen LED-Leuchtmitteln. Die LED-Dioden sind so verteilt, dass sich das Licht in alle Richtungen ausbreitet. Darüber hinaus zeichnet sich die Version Kanlux XLED ST64 durch eine untypische Form aus, die in offenen Lampenabdeckung zur Geltung kommt und jedem Interieur einen dekorativen Charakter verleiht. Kanlux XLED ST64 hat einen bernsteinfarbenen Glaskörper, um die warme Farbe des Lichts zu betonen, bei der ST64C ist er transparent.

Abdeckungsmaterial: Glas

Kanlux XLED ST64 combines the best features of traditional bulbs and modern LED light sources. The LEDs are arranged in such a way that light spreads in all directions. In addition, Kanlux XLED ST64 version has an unusual shape that will stand out in open lampshades and add decorativeness to any interior. Kanlux XLED ST64 is an amber coloured bulb emphasising the warm colour of the light, while ST64C has a transparent bulb.

Lampshade material: glass



XLED ST64 7W-WW	29637	5905339296375	7	55	725	2700	320	E27	F
XLED ST64C 7W-NW	33513	5905339335135	7	60	806	4000	320	E27	E

[V]	[Hz]	FILAMENT	360° Φuse	ellipso s(6)Nackdam	Ra	≥15000	[h]	15000	Hg	CE	EAC	UK CA	↓
220-240 AC	50			80									

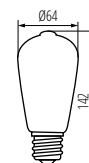

XLED ST64 7W

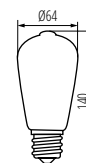

XLED ST64C 7W

# XLED A60 MIRROR

LED-LEUCHTMITTEL ► LED LIGHT SOURCE



XLED A60 M 7W



Dekorative Leuchtmittel Kanlux XLED MIRROR sind mit Silberglanz verziert. Ein Teil der Leuchte ist mit einer Spiegelschicht versehen, die sich perfekt in moderne Arrangements einfügt. Das Licht im Kanlux XLED MIRROR wird von der Reflexionsschicht nach oben reflektiert, was weniger direktes Licht erzeugt und eine gemütliche Atmosphäre schafft. Es wird perfekt in Lampen mit freiliegendem Leuchtmittel als zusätzliche Dekoration oder in Lampen mit Lampenabdeckung, wo wir den Effekt von gedämpftem, stimmungsvollem Licht erreichen können.

Material: Glas

Exceptional, decorative bulbs Kanlux XLED MIRROR provide decorative silver light. Part of the bubble is a mirror coating that will blend in perfectly as an addition to modern designs. The light in Kanlux XLED MIRROR is reflected upwards with a reflective layer, providing less direct light and creating a cosy atmosphere. It is perfect for lamps with an exposed bulb as an additional decoration or for lamps with a lampshade, where we can achieve the effect of subdued, romantic light.

Material: glass



XLED A60 M 7W-WW	<b>33514</b>	5905339335142	7	52	680	2700	150	E27	F
XLED A60 M 7W-NW	<b>33515</b>	5905339335159	7	52	680	4000	150	E27	F

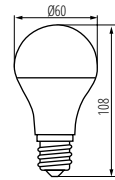

XLED A60 M 7W

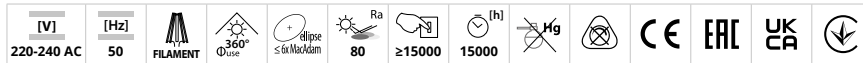

# XLED G95

LED-LEUCHTMITTEL ► LED LIGHT SOURCE



XLED G95 7W-WW



XLED G95 5,8W-NW



Kanlux XLEDs bieten nicht nur die beste Lichtleistung, sondern auch eine zusätzliche Dekoration. Kanlux XLED G95-Leuchtmittel haben einen großen, runden Glaskolben und einen breiten Abstrahlwinkel. Kanlux XLED G95 sehen in offenen Lampen und Wandleuchten sowie in schirmlosen Überhängen sehr eindrucksvoll aus. Besonders hervorzuheben ist das Modell XLED G95S mit dunklem Rauchglas, eine äußerst dekorative, aber auch sehr elegante Lichtquelle.

Abdeckungsmaterial: Glas

Kanlux XLED means not only the best lighting parameters, but also additional decorativeness. Kanlux XLED G95 bulbs are a large, round, glass bulb and a wide beam angle. Kanlux XLED G95 look very impressive in open lamps and wall lamps, as well as in overhangs without a shade. It is worth paying attention to the XLED G95S model with dark, smoked glass, it is an extremely decorative, but also very elegant light source.

Lampshade material: glass



XLED G95 7W-WW	<b>36241</b>	5905339362414	7	55	725	2500	320	E27	F
XLED G95 5,8W-NW	<b>36242</b>	5905339362421	5,8	40	470	4000	320	E27	G

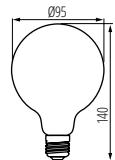

XLED G95

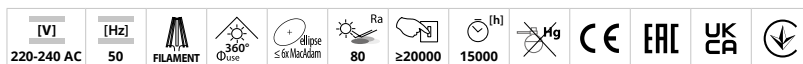

# Kanlux XLED G125

LED-LEUCHTMITTEL ► LED LIGHT SOURCE



XLED G125 7W



XLED G125 7W-WW	<b>29638</b>	5905339296382	7	55	725	2700	320	E27	F
-----------------	--------------	---------------	---	----	-----	------	-----	-----	---

[V]	[Hz]	FILAMENT	360° Φ <sub>use</sub>	±0.5 ≤ 6x Nachdam	Ra	≥15000	[h]	Hg	CE	ERC	UK	CA	↓
220-240 AC	50				80		15000						

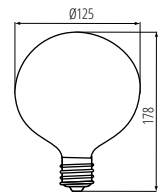

XLED G125 7W



Kanlux XLED bedeutet nicht nur die besten Lichtparameter, sondern auch ein zusätzlicher dekorativer Blickfang. Kanlux XLED G125-Glühlampe ist ein großes rundes Leuchtmittel aus Glas, mit einem weiten Leuchtwinkel. Kanlux XLED G125 präsentiert sich sehr angenehm in offenen Lampen und Wandleuchten sowie in Hängeleuchten ohne Lampenschirm.

Abdeckungsmaterial: Glas

Kanlux XLED does not only mean the best lighting parameters, but also additional decorativeness. Kanlux XLED G125 bulbs are a large round glass bulb and a wide angle of light. Kanlux XLED G125 look very pleasant in open lamps and wall lamps as well as in sags without a shade.

Lampshade material: glass

# Kanlux XLED G125

LED-LEUCHTMITTEL ► LED LIGHT SOURCE



XLED G125 11W

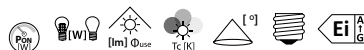

XLED G125 11W-WW	<b>33511</b>	5905339335111	11	99	1520	2700	320	E27	D
XLED G125 11W-NW	<b>33512</b>	5905339335128	11	99	1520	4000	320	E27	D

[V]	[Hz]	FILAMENT	360° Φ <sub>use</sub>	±0.5 ≤ 6x Nachdam	Ra	≥25000	[h]	Hg	CE	ERC	UK	CA	↓
220-240 AC	50				80		15000						

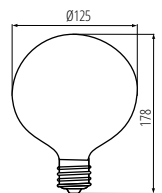

XLED G125 11W



Kanlux XLED GLOBE sind große Leuchtmittel mit dekorativem Charakter. Sie machen sich gut in offenen Leuchten oder in Pendelleuchten, bei denen kein Lampenschirm verwendet wird. Kanlux XLED GLOBE-Quellen haben eine sehr hohe Lichtausbeute und einen breiten Abstrahlwinkel (320 Grad), so dass sie den Raum individuell und effektiv beleuchten können.

Abdeckungsmaterial: Glas

Kanlux XLED GLOBE are large, decorative light sources. They look great in open luminaires or in pendants with no lampshades. Kanlux XLED GLOBE sources have a very high luminous efficacy and a wide beam angle (320 degrees), so a single light source can effectively illuminate a room.

Lampshade material: glass

# Kanlux XLED SW

LED-LEUCHTMITTEL ▶ LED LIGHT SOURCE



XLED A60 4W-SW



XLED C35T 2,5W-SW



XLED ST64 4W-SW



XLED G95 4W-SW



XLED G125 4W-SW



**1800K  
SUPER  
WARM**

**320°**

**DE  
CO  
RI  
function**



Kanlux XLED-Lichtquellen in einer einzigartigen, dekorativen Version helfen Ihnen, eine gemütliche Atmosphäre zu schaffen. Alles dank einer sehr warmen Lichtfarbe, die von einem bernsteinfarbenen Glas und einem spiralförmigen LED-Glühfaden. Diese LED-Glühbirnen dekorieren Ihr Zuhause, Cafe, Restaurant oder jeden anderen Ort. Es ist eine einzigartige Kombination aus Dekorativität und moderner, energiesparender LED Technologie.

Abdeckungsmaterial: Glas

Kanlux XLED light sources in a unique, decorative version will help you create a cozy atmosphere. All thanks to a very warm color of light enclosed in amber glass and a spiral LED filament. These LED bulbs will decorate your home, cafe, restaurant or any other place. It is a unique combination of decorativeness and modern, energy-saving LED technology.

Lampshade material: glass

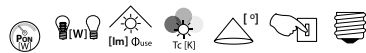

Model	Code	Part No.	W	Watt	lm	lm/lumen	lm/lumen	lm/lumen	lm/lumen	lm/lumen	lm/lumen
XLED C35T 2,5W-SW	29641	5905339296412	2,5	15	135	1800	320	≥15000	E14		
XLED A60 4W-SW	33516	5905339335166	4	25	250	1800	320	≥20000	E27		
XLED ST64 4W-SW	33517	5905339335173	4	25	250	1800	320	≥25000	E27		
XLED G95 4W-SW	33518	5905339335180	4	25	250	1800	320	≥20000	E27		
XLED G125 4W-SW	33519	5905339335197	4	25	250	1800	320	≥20000	E27		



XLED C35T 2,5W-SW

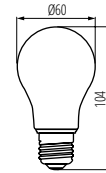

XLED A60 4W-SW

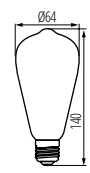

XLED ST64 4W-SW



XLED G95 4W-SW

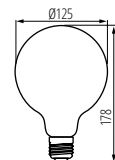

XLED G125 4W-SW

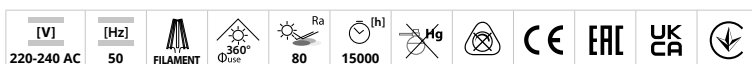

# XLED W

LED-LEUCHTMITTEL ▶ LED LIGHT SOURCE

NEW



XLED W A60 8,5W-WW



XLED W ST64 7W-WW



XLED W C35E14 4,5W-WW



XLED W G45E14 4,5W-WW



Die Kanlux XLED W-Glaskolben haben die klassische Form und Stil, aber mit einem diskreten weißen Glühfaden, was eine Neuheit ist. Sie profitieren von der Energieeffizienz von LEDs, aber die gelben Filamentfäden wurden durch weiße Fäden ersetzt. Die minimalistische XLED W sieht sowohl im eingeschalteten als auch im ausgeschalteten Zustand gut aus. Der einzigartige weiße Glühfaden erzeugt eine warme Farbtemperatur von 2700K. Die Kanlux XLED W ist in den gängigen Formen erhältlich: traditionell, Tropfen, Kerze und ST64..

Abdeckungsmaterial: Glas

The Kanlux XLED W glass bulbs have a classic shape and style while incorporating a discreet white filament, which is a novelty. What you gain is the energy efficiency of LEDs but the yellow filaments have been replaced with white ones. The minimalist XLED W looks remarkably decorative in both on and off mode. The unique white filament produces a warm colour temperature of 2700K. Kanlux XLED W comes in popular shapes: traditional, ball, candle and ST64.

Lampshade material: glass



XLED W A60 8,5W-WW



XLED W ST64 7W-WW

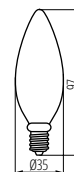

XLED W C35E14 4,5W-WW

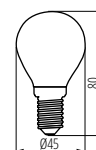

XLED W G45E14 4,5W-WW

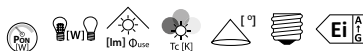

Model	Code	Part No.	Power (W)	Voltage (V)	Lumens (lm)	Temp (K)	Beam angle (°)	Filament	Energy class
XLED W A60 8,5W-WW	37380	5905339373809	8,5	75	1055	2700	320	E27	E
XLED W ST64 7W-WW	37381	5905339373816	7	60	806	2700	320	E27	E
XLED W C35E14 4,5W-WW	37382	5905339373823	4,5	40	470	2700	320	E14	F
XLED W G45E14 4,5W-WW	37383	5905339373830	4,5	40	470	2700	320	E14	F

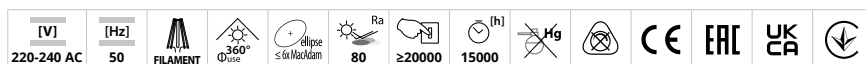



# IQ-LED C35

LED-LEUCHTMITTEL ▶ LED LIGHT SOURCE



IQ-LED C35E14 3,4W



IQ-LED C35E14 3,4W



IQ-LED C35E14 5,9W



Kanlux IQ-LED A35 E14 bietet eine augenfreundliche Farbtemperatur und Zuverlässigkeit, alles im klassischen Kerzendesign. Die neuen Kanlux IQ-LED-Leuchtmittel zeichnen sich zudem durch eine außergewöhnliche Lichtausbeute von bis zu 138 Lumen pro Watt und damit einen geringeren Energieverbrauch aus. Kanlux IQ-LED sorgt für vollen Bedienkomfort und Sicherheit.

Material: Kunststoff

Abdeckungsmaterial: Kunststoff

Kanlux IQ-LED A35 E14 provides an eye-friendly temperature of colour and reliability, and all this in the classic "candle" design. The new IQ-LED bulbs by Kanlux also offer exceptional luminous efficacy, up to 138 Lumens per Watt, and as a result lower energy consumption. IQ-LEDs from Kanlux offer full comfort and safety.

Material: plastic

Lampshade material: plastic



Model	Code	Part No.	Power [W]	Beam Angle [°]	Luminous Flux [lm]	Beam Diameter [mm]	Height [mm]	Base	Energy Class
IQ-LED C35E14 3,4W-WW	36682	5905339366825	3,4	40	470	2700	240	E14	D
IQ-LED C35E14 3,4W-NW	36683	5905339366832	3,4	40	470	4000	240	E14	D
IQ-LED C35E14 3,4W-CW	36684	5905339366849	3,4	40	470	6500	240	E14	D
IQ-LED C35E14 5,9W-WW	36685	5905339366856	5,9	60	806	2700	240	E14	D
IQ-LED C35E14 5,9W-NW	36686	5905339366863	5,9	60	806	4000	240	E14	D
IQ-LED C35E14 5,9W-CW	36687	5905339366870	5,9	60	806	6500	240	E14	D

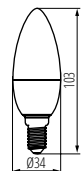

IQ-LED C35E14

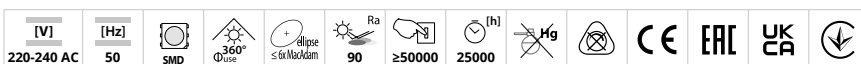

# Kanlux XLEDEX C35

LED-LEUCHTMITTEL ► LED LIGHT SOURCE

NEW



XLEDEX C35E14 3,8W

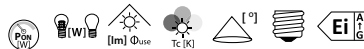

XLEDEX C35E14 3,8W-WW	<b>37340</b>	5905339373403	3,8	60	806	2700	320	E14	A
XLEDEX C35E14 3,8W-NW	<b>37341</b>	5905339373410	3,8	60	806	4000	320	E14	A



Das EXTREM effiziente Kanlux XLED EX C35 3,8W LED Leuchtmittel entspricht der Leistung einer 60-W-Glühbirne. Ihre hervorragende Lichtausbeute (210 Lumen pro Watt) machen diese Lichtquellen 15 Mal effizienter als ihre als ihre traditionellen, herkömmlichen Vorgänger. Eine 5-Jahres-Garantie, 50.000 Stunden Lebensdauer und 50.000 ON/OFF-Zyklen sind zusätzliche Vorteile. Darüber hinaus verfügt die Kanlux XLED EX C35 über einen Glaskolben und Glühfäden, die sie Glühbirnen ähnelt lässt, aber die neuesten Fortschritte in der LED-Technologie beinhaltet.

5 Jahre Garantie gemäß den Bedingungen der Garantieerklärung, die auf der Website verfügbar ist

Abdeckungsmaterial: Glas

EXTREMELY efficient Kanlux XLED EX C35 3,8W light sources are equivalent to 60W incandescent bulbs. Their outstanding luminous efficacy (210 lumens per watt) makes these light sources 15 times more efficient than their traditional, standard antecedents. A 5-year warranty, 50,000 hours of durability and 50,000 ON/OFF cycles are additional advantages. What's more, the Kanlux XLED EX C35 has a glass bulb and filament 'rods' that make it similar to traditional incandescent bulbs but incorporates the latest advances in LED technology.

5 years Warranty under the terms of the warranty statement, available on our website  
Lampshade material: glass

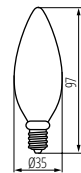

XLED EX C35E14 3,8W

# Kanlux XLEDDIM C35

LED-LEUCHTMITTEL ► LED LIGHT SOURCE



XLEDDIM C35E14 5,9W-WW

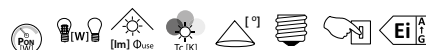

XLEDDIM C35E14 5,9W-WW	<b>35278</b>	5905339352781	5,9	60	806	2700	320	E14	≥25000	D
------------------------	--------------	---------------	-----	----	-----	------	-----	-----	--------	---

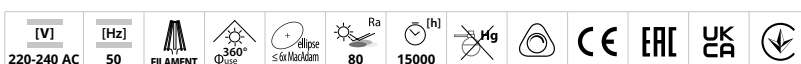

Kanlux XLEDDIM C35 kombiniert die besten Eigenschaften traditioneller Glühbirnen und moderner LED-Leuchtmittel, hier in dimmbar. Deshalb nennen wir sie das erste „echte LED-Leuchtmittel“. Ein Glaskörper in Form eine traditionelle Kerze und die LEDs, die so angeordnet sind, dass sich das Licht in alle Richtungen ausbreitet und der Beleuchtungswinkel bis zu 320 Grad beträgt! Die XLED DIM C35 ist für die Verwendung mit einem Dimmer geeignet.

Abdeckungsmaterial: Glas

Kanlux XLED combines the best features of traditional light bulbs and modern LED light sources. That is why we call it the first real "LED bulb". The glass bulb is in the shape of a traditional "candle", and the LEDs are arranged in such a way that the light spreads in all directions, and the beam angle is up to 320 degrees! XLED DIM C35 is adapted to work with a dimmer.

Lampshade material: glass

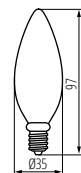

XLEDDIM C35E14 5,9W-WW

# Kanlux XLED C35

LED-LEUCHTMITTEL ► LED LIGHT SOURCE



XLED C35E14 2,5W

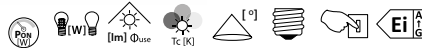

Model	Part No.	Power [W]	Beam Angle [°]	Lumen [lm]	Temp. [K]	Beam Spread [°]	Base	Life [h]	Class	
XLED C35E14 2,5W-WW	29617	5905339296177	2,5	25	250	2700	320	E14	≥15000	F
XLED C35E14 4,5W-WW	29618	5905339296184	4,5	40	470	2700	320	E14	≥15000	F
XLED C35E14 4,5W-NW	29619	5905339296191	4,5	40	470	4000	320	E14	≥15000	F
XLED C35 E14 6W-WW	35272	5905339352729	6	60	806	2700	320	E14	≥25000	E
XLED C35 E14 6W-NW	35273	5905339352736	6	60	806	4000	320	E14	≥25000	E

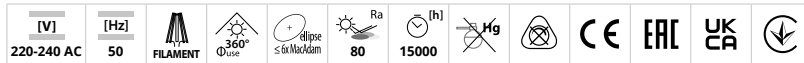

Kanlux XLED kombiniert die besten Eigenschaften einer herkömmlichen Glühlampe und modernem LED-Leuchtmittel. Deshalb nennen wir sie das erste echte „LED-LEUCHTMITTEL“. Ein Glaskörper in Form einer traditionellen „Kerze“ und LEDs, die so angeordnet sind, dass sich das Licht in alle Richtungen ausbreitet und der Ausstrahlungswinkel sogar bis zu 320 Grad beträgt!

Abdeckungsmaterial: Glas

Kanlux XLED combines the best features of traditional bulbs and modern LED light sources. Therefore, we talk about it as the first real LED bulb. A glass bulb in the shape of a traditional "candle" and LED diodes placed in such a way so that light can part in all directions, and the angle of light comes to even 320 degrees!

Lampshade material: glass

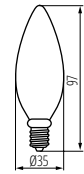

XLED C35 E14

# Kanlux XLED C35M

LED-LEUCHTMITTEL ► LED LIGHT SOURCE



XLED C35E14 4,5W, XLED C35E14 6W



XLED C35E27 6W



Model	Part No.	Power [W]	Beam Angle [°]	Lumen [lm]	Temp. [K]	Beam Spread [°]	Base	Life [h]	Class	
XLED C35E14 4,5W-WW-M	29620	5905339296207	4,5	40	470	2700	320	E14	15000	F
XLED C35E14 4,5W-NW-M	29621	5905339296214	4,5	40	470	4000	320	E14	15000	F
XLED C35E14 6W-WW-M	29622	5905339296221	6	60	810	2700	320	E14	10000	D
XLED C35E14 6W-NW-M	29623	5905339296238	6	60	810	4000	320	E14	10000	D
XLED C35E27 6W-WW-M	29646	5905339296467	6	60	810	2700	320	E27	10000	D
XLED C35E27 6W-NW-M	29647	5905339296474	6	60	810	4000	320	E27	10000	D

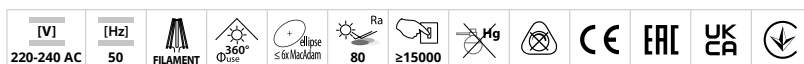

Kanlux XLED kombiniert die besten Eigenschaften einer herkömmlichen Glühlampe und modernem LED-Leuchtmittel. Deshalb nennen wir sie das erste echte „LED-LEUCHTMITTEL“. Ein Glaskörper in Form einer traditionellen „Kerze“ und LEDs, die so angeordnet sind, dass sich das Licht in alle Richtungen ausbreitet und der Ausstrahlungswinkel sogar bis zu 320 Grad beträgt!

Abdeckungsmaterial: Glas

Kanlux XLED combines the best features of traditional bulbs and modern LED light sources. Therefore, we talk about it as the first real LED bulb. A mat bulb in the shape of a traditional "candle" and LED diodes placed in such a way so that light can part in all directions, and the angle of light comes to even 320 degrees!

Lampshade material: glass

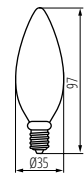

XLED C35E14 4,5W, XLED C35E14 6W

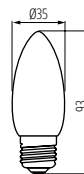

XLED C35E27 6W

# Kanlux DUN LED

LED-LEUCHTMITTEL ► LED LIGHT SOURCE

NEW



DUN 4,9W E14; DUN 6,5W E14

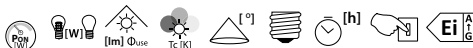

Model	Part No.	Power [W]	Beam Angle [°]	Luminous Flux [lm]	Temp. [K]	Beam Spread [°]	Base	Lifetime [h]	lm/W	Energy Class
DUN 4,9W E14-WW	23434	4,9	40	470	3000	200	E14	15000	≥25000	F
DUN 4,9W E14-NW	23435	4,9	40	470	4000	200	E14	15000	≥25000	F
DUN 6,5W E14-NW	23436	6,5	60	806	4000	200	E14	20000	≥25000	E
DUN 6,5W E14-WW	23437	6,5	60	806	3000	200	E14	20000	≥25000	E

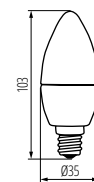
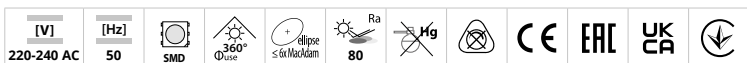

DUN 4,9W E14; DUN 6,5W E14



Die kleine Kanlux DUN ist eine kerzenförmige Glühlampe mit E14-Sockel. Die Lebensdauer dieser Leuchtmittel wird durch die Kombination von SMD-LEDs und einem Keramikgehäuse erzielt. Kanlux DUN zeichnet sich durch eine hohe Lichtausbeute aus. Sie eignen sich ideal für Wandlampen und Kronleuchter in allen Bereichen, in denen trotz geringer Lichtausbeute viel Licht erzeugt werden soll.

Material: Kunststoff

The small-size Kanlux DUN is a "candle-type" bulb with E14 screw. Durability of these light sources results from the combination of LED SMD diodes and ceramic housing. Kanlux DUN are characterised by high luminous efficiency. They are perfect for wall lamps and chandeliers in all places where we want to get a lot of light even though its source is small.

Material: plastic

# Kanlux IDO LED

LED-LEUCHTMITTEL ► LED LIGHT SOURCE

NEW



IDO 6,5W E14



Model	Part No.	Power [W]	Beam Angle [°]	Luminous Flux [lm]	Temp. [K]	Beam Spread [°]	Base	Lifetime [h]	lm/W	Energy Class
IDO 6,5W E14-NW	23438	6,5	60	806	4000	200	E14	20000	≥25000	E
IDO 6,5W E14-WW	23439	6,5	60	806	3000	200	E14	20000	≥25000	E

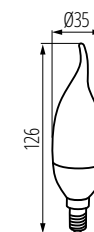
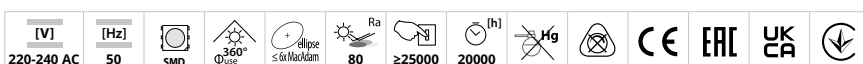

IDO 6,5W E14



Die kleine Kanlux IDO ist eine „Kerzen“ - Leuchtmittel mit E14-Sockel. Die Langlebigkeit und Energieeffizienz dieser Quellen wurde durch die Verwendung von SMD-LEDs erreicht. Die Kanlux IDO zeichnen sich durch eine hohe Lichtausbeute aus. Sie eignen sich perfekt für Wandlampen und Kronleuchter an allen Orten, an denen wir trotz einer kleinen Quelle viel Licht erhalten wollen.

Material: Kunststoff

Abdeckungsmaterial: Kunststoff

The small-sized Kanlux IDO is a "candle" type bulb with an E14 cap. The durability and energy efficiency of these sources have been made possible through the use of SMD LEDs. Kanlux IDOs have a high luminous efficiency. They are perfect for wall lamps and chandeliers in all places where you want to get a lot of light even though its source is small.

Material: plastic

Lampshade material: plastic

# IQ-LED G45

LED-LEUCHTMITTEL ► LED LIGHT SOURCE

NEW



IQ-LED G45E14 3,4W



IQ-LED G45E27 3,4W



IQ-LED G45E14 5,9W



IQ-LED G45E27 5,9W

**WARRANTY**  
3 years

**SAFE**  
light

**Ra90+**  
true colors

**QUALITY & COMFORT**  
of light

Kanlux IQ-LED G45 bietet eine augenfreundliche Farbtemperatur und Zuverlässigkeit, alles im klassischen Kugeldesign. Die neuen Kanlux IQ-LED-Leuchtmittel zeichnen sich zudem durch eine außergewöhnliche Lichtausbeute von bis zu 138 Lumen pro Watt und damit einen geringeren Energieverbrauch aus. Kanlux IQ-LED G45 sind mit E14- und E27-Sockel erhältlich, diese Lichtquellen gewährleisten vollen Nutzungskomfort und Sicherheit.

Material: Kunststoff

Abdeckungsmaterial: Kunststoff

Kanlux IQ-LED G45 is an eye-friendly color temperature and reliability, all preserved in classic ball design. New IQ-LED Kanlux bulbs it also has exceptional luminous efficiency, up to 138 lumens per Watt, and therefore lower energy consumption. IQ-LED Kanlux G45 is available in a version with a cup E14 and E27, these light sources provide complete comfort use and safety.

Material: plastic

Lampshade material: plastic



Model	Code	Power (W)	Beam Angle (°)	Light Output (lm)	Color Temp (K)	Base	Energy Class
IQ-LED G45E14 3,4W-WW	36688	3,4	40	470	2700	E14	D
IQ-LED G45E14 3,4W-NW	36689	3,4	40	470	4000	E14	D
IQ-LED G45E14 3,4W-CW	36690	3,4	40	470	6500	E14	D
IQ-LED G45E27 3,4W-WW	36691	3,4	40	470	2700	E27	D
IQ-LED G45E27 3,4W-NW	36692	3,4	40	470	4000	E27	D
IQ-LED G45E27 3,4W-CW	36693	3,4	40	470	6500	E27	D
IQ-LED G45E14 5,9W-WW	36694	5,9	60	806	2700	E14	D
IQ-LED G45E14 5,9W-NW	36695	5,9	60	806	4000	E14	D
IQ-LED G45E14 5,9W-CW	36696	5,9	60	806	6500	E14	D
IQ-LED G45E27 5,9W-WW	36697	5,9	60	806	2700	E27	D
IQ-LED G45E27 5,9W-NW	36698	5,9	60	806	4000	E27	D
IQ-LED G45E27 5,9W-CW	36699	5,9	60	806	6500	E27	D

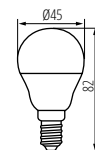

IQ-LED G45E14 3,4W

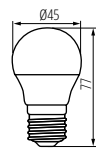

IQ-LED G45E27 3,4W

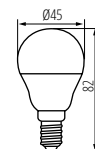

IQ-LED G45E14 5,9W

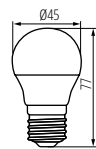

IQ-LED G45E27 5,9W

[V]

220-240 AC

[Hz]

50

SMD

360°  
use

dimmbare  
LED-Modul

Ra  
90

≥50000  
25000

Hg

Kanlux

# XLEDEX G45

LED-LEUCHTMITTEL ▶ LED LIGHT SOURCE

NEW



XLEDEX G45E14 3,8W



XLEDEX G45E27 3,8W



Die EXTREME effizienten Kanlux XLED EX G45 3,8W Lichtquellen sind gleichwertig mit alten 60W-Glühlampen. Ihre hervorragende Lichtausbeute (210 Lumen pro Watt) machen diese Lichtquellen 15 Mal effizienter als ihre traditionellen, herkömmlichen Vorgänger. Eine 5-Jahres-Garantie, 50.000 Stunden Lebensdauer und 50.000 ON/OFF-Zyklen sind zusätzliche Vorteile. Darüber hinaus verfügt die Kanlux XLED EX G45 über einen Glaskolben und Glühfadenstäbchen, die sie Glühlampen ähneln lässt, aber die neuesten Fortschritte in der LED Technologie beinhaltet.

5 Jahre Garantie gemäß den Bedingungen der Garantieerklärung, die auf der Website verfügbar ist  
Abdeckungsmaterial: Glas

EXTREMELY efficient Kanlux XLED EX G45 3,8W light sources are equivalent to 60W incandescent bulbs. Their outstanding luminous efficacy (210 lumens per watt) makes these light sources 15 times more efficient than their traditional, standard antecedents. A 5-year warranty, 50,000 hours of durability and 50,000 ON/OFF cycles are additional advantages. What's more, the Kanlux XLED EX G45 has a glass bulb and filament 'rods' that make it similar to traditional incandescent bulbs but incorporates the latest advances in LED technology.

5 years Warranty under the terms of the warranty statement, available on our website  
Lampshade material: glass

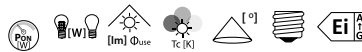

Model	Code	Part No.	Power (W)	Power Factor	Lumen (lm)	Beam Angle (°)	Height (mm)	Base	Class
XLEDEX G45E14 3,8W-WW	37342	5905339373427	3,8	60	806	2700	320	E14	A
XLEDEX G45E14 3,8W-NW	37343	5905339373434	3,8	60	806	4000	320	E14	A
XLEDEX G45E27 3,8W-WW	37344	5905339373441	3,8	60	806	2700	320	E27	A
XLEDEX G45E27 3,8W-NW	37345	5905339373458	3,8	60	806	4000	320	E27	A

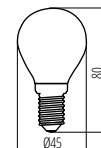

XLEDEX G45E14 3,8W

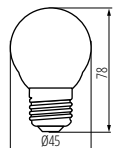

XLEDEX G45E27 3,8W



# XLED G45

LED-LEUCHTMITTEL ▶ LED LIGHT SOURCE



XLED G45 E14 4,5W

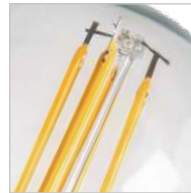

Kanlux XLED kombiniert die besten Eigenschaften einer herkömmlichen Glühlampe und modernen LED-Leuchtmitteln. Deshalb nennen wir sie das erste echte „LED-LEUCHTMITTEL“. Ein Glaskörper in Form einer traditionellen „Kugel“ und LEDs, die so angeordnet sind, dass sich das Licht in alle Richtungen ausbreitet. Zur Auswahl stehen Leuchtmittel mit E27- und E14-Sockel.

Abdeckungsmaterial: Glas

Kanlux XLED combines the best features of traditional bulbs and modern LED light sources. Therefore, we talk about it as the first real LED bulb. A glass bulb in the shape of a traditional "ball" and LED diodes placed in such a way so that light can part in all directions. You choose from sources with E27 and E14 light bulb bases.

Lampshade material: glass



XLED G45 E27 4,5W



XLED G45 E14 6W



XLED G45 E27 6W

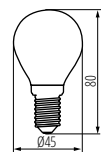

XLED G45 E14

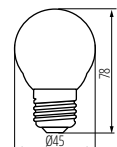

XLED G45 E27



	[W]	[lm]	TC [K]	[°]		[h]				
XLED G45 E14 4,5W-WW	29624	5905339296245	4,5	40	470	2700	320	E14	≥15000	F
XLED G45 E27 4,5W-WW	29625	5905339296252	4,5	40	470	2700	320	E27	≥15000	F
XLED G45 E27 6W-WW	35274	5905339352743	6	60	806	2700	320	E27	≥25000	E
XLED G45 E27 6W-NW	35275	5905339352750	6	60	806	4000	320	E27	≥25000	E
XLED G45 E14 6W-WW	35276	5905339352767	6	60	806	2700	320	E14	≥25000	E
XLED G45 E14 6W-NW	35277	5905339352774	6	60	806	4000	320	E14	≥25000	E

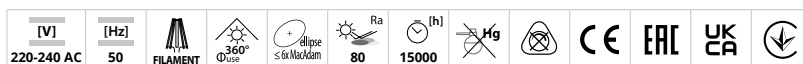

# XLED G45M

LED-LEUCHTMITTEL ► LED LIGHT SOURCE



XLED G45E14 4,5W, XLED G45E14 6W



XLED G45E14 4,5W, XLED G45E14 6W



XLED G45E27 4,5W, XLED G45E27 6W



Kanlux XLED kombiniert die besten Eigenschaften einer herkömmlichen Glühlampe und modernen LED-Leuchtmitteln. Deshalb nennen wir sie das erste echte „LED-LEUCHTMITTEL“. Ein Glaskörper in Form einer traditionellen „Kugel“ und LEDs, die so angeordnet sind, dass sich das Licht in alle Richtungen ausbreitet. Zur Auswahl stehen Leuchtmittel mit E27- und E14-Sockel.

Abdeckungsmaterial: Glas

Kanlux XLED combines the best features of traditional bulbs and modern LED light sources. Therefore, we talk about it as the first real LED bulb. A mat bulb in the shape of a traditional "ball" and LED diodes placed in such a way so that light can part in all directions. You choose from sources with E27 and E14 light bulb bases.

Lampshade material: glass



XLED G45E14 4,5W-WW-M	29626	5905339296269	4,5	40	470	2700	320	E14	15000	F		
XLED G45E14 4,5W-NW-M	29627	5905339296276	4,5	40	470	4000	320	E14	15000	F		
XLED G45 E14 6W-WW-M	29628	5905339296283	6	60	810	2700	320	E14	10000	D		
XLED G45 E14 6W-NW-M	29629	5905339296290	6	60	810	4000	320	E14	10000	D		
XLED G45E27 4,5W-WW-M	29630	5905339296306	4,5	40	470	2700	320	E27	15000	F		
XLED G45E27 4,5W-NW-M	29631	5905339296313	4,5	40	470	4000	320	E27	15000	F		
XLED G45 E27 6W-WW-M	29632	5905339296320	6	60	810	2700	320	E27	10000	D		
XLED G45 E27 6W-NW-M	29633	5905339296337	6	60	810	4000	320	E27	10000	D		

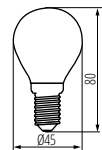

XLED G45E14 4,5W, XLED G45E14 6W

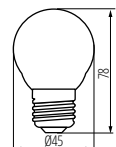

XLED G45E27 4,5W, XLED G45E27 6W

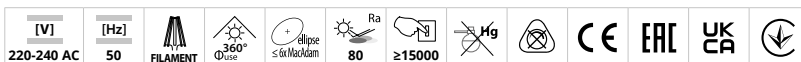



# BILO LED

LED-LEUCHTMITTEL ▶ LED LIGHT SOURCE



BILO 4,9W E27



BILO 4,9W E14



BILO 6,5W E27



BILO 6,5W E14



Bei Kanlux BILO dreht sich alles um Langlebigkeit, die durch die SMD-LED-Technologie und eine hybride Kühlkörperstruktur erreicht wird. Alle Kanlux BILO 4,9W-Modelle zeichnen sich durch eine hohe Lichtausbeute aus. Diese kugelförmigen Leuchtmittel mit E14- und E27-Sockel eignen sich ideal für Wandlampen und Kronleuchter an allen Orten, an denen Ästhetik und eine mittlere Lichtmenge bei geringer Leistung wichtig sind. Außerdem trägt der geringe Stromverbrauch dazu bei, dass Energiekosten gespart werden.

Material: Kunststoff

Abdeckungsmaterial: Kunststoff

Kanlux BILO means durability, which has been achieved thanks to LED SMD technology and a hybrid structure of the radiator. All Kanlux BILO 4.9W models are characterized by high light efficiency. These golf ball-shaped E14 and E27 bulbs are perfect for sconces and chandeliers in all places where aesthetics and an average amount of light with low power are important. In addition, low power consumption helps to save energy costs.

Material: plastic

Lampshade material: plastic

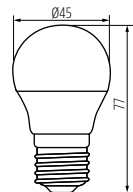

BILO E27

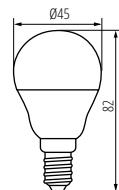

BILO E14



	[W]	[lm]	[°]	[K]	[h]	[lm]	[h]	[E]	[A]	
BILO 4,9W E27-NW	<b>23418</b>	5905339234186	4,9	40	470	4000	160	15000	E27	F
BILO 4,9W E27-WW	<b>23419</b>	5905339234193	4,9	40	470	3000	160	15000	E27	F
BILO 4,9W E14-NW	<b>23428</b>	5905339234285	4,9	40	470	4000	160	15000	E14	F
BILO 4,9W E14-WW	<b>23429</b>	5905339234292	4,9	40	470	3000	160	15000	E14	F
BILO 6,5W E14-NW	<b>26766</b>	5905339267665	6,5	60	806	4000	150	20000	E14	E
BILO 6,5W E14-WW	<b>26767</b>	5905339267672	6,5	60	806	3000	150	20000	E14	E
BILO 6,5W E27-NW	<b>26768</b>	5905339267689	6,5	60	806	4000	150	20000	E27	E
BILO 6,5W E27-WW	<b>26769</b>	5905339267696	6,5	60	806	3000	150	20000	E27	E



# IQ-LEDEX GU10

LED-LEUCHTMITTEL ► LED LIGHT SOURCE



IQ-LEDEX GU10 2,5W-NW

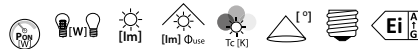

IQ-LEDEX GU10 2,5W-NW	<b>33769</b>	5905339337696	2,5	54	460	450	4000	100	GU10	A
-----------------------	--------------	---------------	-----	----	-----	-----	------	-----	------	---

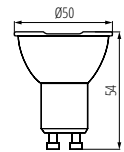

IQ-LEDEX GU10 2,5W-NW



Kanlux iQ-LED EX GU10 ist eine neue Lichtquelle mit GU10-Sockel in der bekannten und beliebten Produktreihe Kanlux IQ-LED. Sie zeichnet sich durch extreme Lichtausbeute aus, verbraucht nur 2,5 W Energie und liefert so viel Licht wie eine herkömmliche 54 W! 450 Lumen Licht, Energieeffizienzklasse A, 50.000 Stunden Licht - das sind die wichtigsten Vorteile dieser Quelle. Darüber hinaus verfügt die Kanlux IQ-LED EX GU10 über alle Vorteile der IQ-LED-Reihe, was durch das TÜV Rheinland-Zertifikat bestätigt wird.

5 Jahre Garantie gemäß den Bedingungen der Garantieerklärung, die auf der Website verfügbar ist

Abdeckungsmaterial: Kunststoff

Kanlux IQ-LED EX GU10 is a new light source with a GU10 base in the well-known and popular series of Kanlux IQ-LED products. They are characterized by extreme luminous efficiency, consume only 2.5W of energy, and give as much light as traditional 54W! 450 lumens of light, energy efficiency class A, 50,000 hours of lighting - these are the most important advantages of this source. In addition, Kanlux IQ-LED EX GU10 has all the advantages of the IQ-LED series.

5 years Warranty under the terms of the warranty statement, available on our website  
Lampshade material: plastic

# IQ-LED GU10 4,9W

LED-LEUCHTMITTEL ► LED LIGHT SOURCE



IQ-LED GU10 4,9W



IQ-LED GU10 4,9W-WW	<b>35256</b>	5905339352569	4,9	44	550	2700	120	GU10	E
IQ-LED GU10 4,9W-NW	<b>35257</b>	5905339352576	4,9	44	550	4000	120	GU10	E
IQ-LED GU10 4,9W-CW	<b>35258</b>	5905339352583	4,9	44	550	6500	120	GU10	E

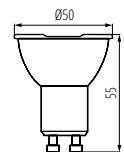

IQ-LED GU10 4,9W



Kanlux IQ-LED GU10 bietet eine augenfreundliche Farbtemperatur und Zuverlässigkeit, und das alles in der klassischen Form einer Halogenlampe. Die neuen iQ-LED GU10-Leuchtmittel von Kanlux bieten außerdem eine außergewöhnliche Lichtausbeute von mehr als 100 Lumen pro Watt und damit einen geringeren Energieverbrauch. Die IQ-LED GU10 bieten vollen Benutzerkomfort dank ihrer präzisen Farbwiedergabe (Ra 90).

Material: Glas

Abdeckungsmaterial: Kunststoff

Kanlux IQ-LED GU10 provides an eye-friendly temperature of colour and reliability, and all this in the classic shape of halogen bulbs. The new iQ-LED GU10 bulbs by Kanlux also offer exceptional luminous efficacy, more than 100 Lumens per Watt, and as a result lower energy consumption. IQ-LED GU10s provide full user comfort with their accurate colour reproduction (Ra 90).

Material: glass

Lampshade material: plastic

# IQ-LED GU10

LED-LEUCHTMITTEL ▶ LED LIGHT SOURCE



IQ-LED GU10 6,5W



IQ-LED GU10 6,5WS3



Kanlux IQ-LED steht für photobiologische Sicherheit, augenfreundliche Farbtemperatur und Zuverlässigkeit. Jetzt ist das alles in der neuen Version mit GU10-Sockel erhältlich. IQ-LED-LEUCHTMITTEL bieten vollen Nutzungskomfort und Sicherheit, was durch das TÜV Rheinland Zertifikat bestätigt wird.

Abdeckungsmaterial: Kunststoff



Kanlux IQ-LED means photo-biological safety, colour temperature friendly to eyes and reliability. Now, all this in a new version with GU10 light bulb base. IQ-LED bulbs ensure full comfort of use and safety.

Lampshade material: plastic



			[W]	[lm]	[lm] Øuse	Tc (K)	[°]	[h]		
IQ-LED GU10 6,5W-WW	<b>35240</b>	5905339352408	6,5	59	580	510	2700	110	GU10	F
IQ-LED GU10 6,5W-NW	<b>35241</b>	5905339352415	6,5	60	585	515	4000	110	GU10	F
IQ-LED GU10 6,5W-CW	<b>35242</b>	5905339352422	6,5	60	585	515	6500	110	GU10	F
IQ-LED GU10 6,5WS3-WW	<b>35243</b>	5905339352439	6,5	85	580	535	2700	36	GU10	F
IQ-LED GU10 6,5WS3-NW	<b>35244</b>	5905339352446	6,5	86	580	540	4000	36	GU10	F
IQ-LED GU10 6,5WS3-CW	<b>35245</b>	5905339352453	6,5	86	580	540	6500	36	GU10	F

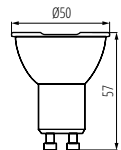

IQ-LED GU10 6,5W

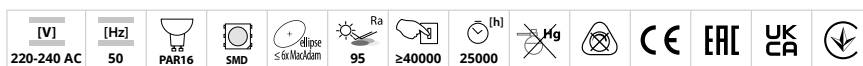

Kanlux

# IQ-LEDDIM GU10

LED-LEUCHTMITTEL ▶ LED LIGHT SOURCE



IQ-LEDDIM GU10 7W



Kanlux IQ-LED steht für photobiologische Sicherheit, augenfreundliche Farbtemperatur und Zuverlässigkeit. Das alles jetzt in einer neuen Version mit GU10-Sockel - die IQ-LEDDIM-Version arbeitet zusätzlich mit Dimmern. IQ-LED-Lampen bieten vollen Benutzerkomfort und Sicherheit, was durch die Zertifizierung des TÜV Rheinland bestätigt wird.

Abdeckungsmaterial: Kunststoff

Kanlux IQ-LEDs ensure photobiological safety, have a colour temperature that is beneficial to the eyes and are reliable. A new version with GU10 cap is now available - additionally the IQ-LEDDIM version is compatible with dimmers. IQ-LED bulbs provide full comfort and safety.

Lampshade material: plastic

			Power [W]	Beam angle [°]	Light output [lm]	Beam diameter [mm]	Beam diameter [mm]	Beam diameter [mm]	Beam diameter [mm]	Beam diameter [mm]	Beam diameter [mm]	Beam diameter [mm]	Beam diameter [mm]	Beam diameter [mm]	Beam diameter [mm]
IQ-LEDDIM GU10 7W-WW	35246	5905339352460	7	59	570	490	2700	110	GU10	G					
IQ-LEDDIM GU10 7W-NW	35247	5905339352477	7	60	575	495	4000	110	GU10	G					
IQ-LEDDIM GU10 7W-CW	35248	5905339352484	7	60	575	495	6500	110	GU10	G					

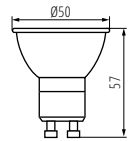
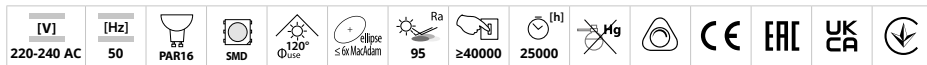

IQ-LEDDIM GU10 7W

Kanlux

# K LED GU10 6W

LED-LEUCHTMITTEL ▶ LED LIGHT SOURCE



K LED GU10 6W



Kanlux K LED GU10 sind zwei Typen von sparsamen LED-Leuchtmitteln. Mit einem Lichtstrom von bis zu 600 Lumen können sie in jedem Raum als Zusatzlicht oder durch die Kombination mehrerer Quellen als starkes Hauptlicht eingesetzt werden. Dank einer Auswahl von zwei Farben (neutral und kalt) können sie erfolgreich an unsere Vorlieben angepasst werden.

Material: Kunststoff  
Abdeckungsmaterial: Kunststoff

Kanlux K LED GU10 are two types of economical LED light sources. The luminous flux of up to 600 lumens makes it possible to use them in any room as supplementary light or by combining several sources as the main, strong light. Thanks to two colors to choose from (neutral and cold), we can successfully match them to our preferences.

Material: plastic  
Lampshade material: plastic

			Power [W]	Beam angle [°]	Light output [lm]	Beam diameter [mm]	Beam diameter [mm]	Beam diameter [mm]	Beam diameter [mm]	Beam diameter [mm]	Beam diameter [mm]	Beam diameter [mm]	Beam diameter [mm]	Beam diameter [mm]	Beam diameter [mm]
KLED GU10 6W-NW	36331	5905339363312	6	50	560	500	4000	100	GU10	F					
KLED GU10 6W-CW	36332	5905339363329	6	50	560	500	6500	100	GU10	F					
KLED N GU10 6W-WW	36333	5905339363336	6	50	560	485	3000	100	GU10	F					

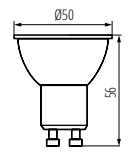
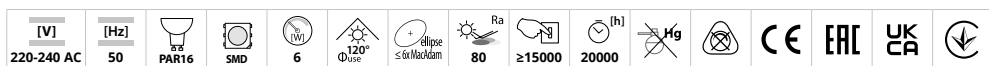

K LED GU10 6W

# TOMiv2 LED

LED-LEUCHTMITTEL ► LED LIGHT SOURCE



Kanlux TOMiv2 ist eine neue, noch effizientere Konstruktion, die hohe Beleuchtungsparameter gewährleistet. Dank der Verwendung einer matten Abdeckung wird das Licht in diesen Leuchtmitteln gleichmäßig verteilt. Außerdem zeichnen sich diese Leuchte durch eine hohe Lichtausbeute aus.

Material: Kunststoff

Abdeckungsmaterial: Kunststoff

Kanlux TOMiv2 is a new and even more efficient design ensuring high lighting parameters. Thanks to the application of a matt cover, the light in these lamps is distributed evenly. Moreover, these lamps are characterised by high luminous efficiency.

Material: plastic

Lampshade material: plastic

TOMiv2 1,2W GU10



TOMiv2 2,9W GU10



TOMiv2 4,9W GU10



TOMiv2 6,5W GU10

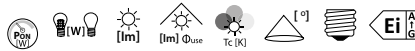

Model	Code	Part No.	Power (W)	Beam Angle (°)	Height (mm)	Width (mm)	Temp. (K)	Beam Angle (°)	Base	Class
TOMiv2 1,2W GU10-CW	34960	5905339349606	1,2	15	120	105	6500	100	GU10	F
TOMiv2 1,2W GU10-NW	34961	5905339349613	1,2	15	120	105	4000	100	GU10	F
TOMiv2 1,2W GU10-WW	34962	5905339349620	1,2	15	120	105	3000	100	GU10	F
TOMiv2 2,9W GU10-CW	34963	5905339349637	2,9	28	295	240	6500	100	GU10	F
TOMiv2 2,9W GU10-NW	34964	5905339349644	2,9	28	295	240	4000	100	GU10	F
TOMiv2 2,9W GU10-WW	34965	5905339349651	2,9	28	295	240	3000	100	GU10	F
TOMiv2 4,9W GU10-CW	34966	5905339349668	4,9	42	490	400	6500	100	GU10	F
TOMiv2 4,9W GU10-NW	34967	5905339349675	4,9	42	490	400	4000	100	GU10	F
TOMiv2 4,9W GU10-WW	34968	5905339349682	4,9	42	490	400	3000	100	GU10	F
TOMiv2 6,5W GU10-CW	34969	5905339349699	6,5	61	650	530	6500	100	GU10	F
TOMiv2 6,5W GU10-NW	34970	5905339349705	6,5	61	650	530	4000	100	GU10	F
TOMiv2 6,5W GU10-WW	34971	5905339349712	6,5	61	650	530	3000	100	GU10	F

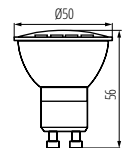

TOMiv2 GU10

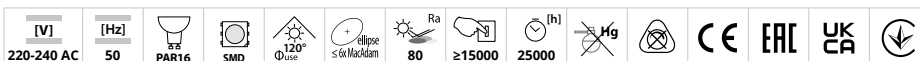

# Kanlux REMI LED

LED-LEUCHTMITTEL ► LED LIGHT SOURCE



REMI LED GU10

			Power [W]	Power factor	Beam angle [°]	Light output [lm]	Color temperature [K]	Beam diameter [mm]	Base	Beam spread
REMI LED GU10-NW	<b>33080</b>	5905339330802	2,2	200	180	4000	100	GU10	F	
REMI LED GU10-WW	<b>33081</b>	5905339330819	2,2	180	165	3000	100	GU10	F	
REMI LED GU10-CW	<b>33082</b>	5905339330826	2,2	200	180	6500	100	GU10	F	

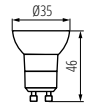

REMI LED GU10

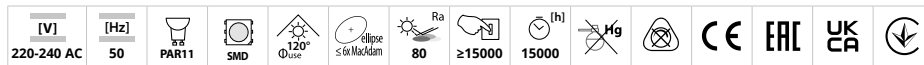

# Kanlux TEDI MAXX LED

LED-LEUCHTMITTEL ► LED LIGHT SOURCE



TEDI MAXX LED GU10



Kanlux TEDI MAXX ist eine Kraft, die in einem kleinen Körper steckt. Effiziente LEDs und Keramikgehäuse sind nur einige der Vorteile dieser Leuchtmittel. Das stabilisierte Netzteil minimiert den Flackereffekt, der zu Augenschmerzen führen kann. Darüber hinaus hat Kanlux TEDI MAXX eine Lichtleistung von 100lm pro Watt. Das mattierte Glas sorgt für eine gleichmäßige Lichtverteilung.

Material: Keramik  
Abdeckungsmaterial: Kunststoff

The Kanlux TEDI MAXX is power enclosed in a small body. Efficient LED's and ceramic casing are just two of the advantages of this light source. The stabilised power supply minimises the flicker effect, which could cause eye fatigue. In addition, The Kanlux TEDI MAXX has a light output of 100lm per 1 Watt, and the matte glass used ensures uniform light distribution.

Material: ceramics  
Lampshade material: plastic

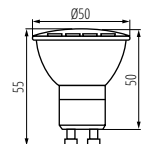

TEDI MAXX LED GU10

			Power [W]	Power factor	Beam angle [°]	Light output [lm]	Color temperature [K]	Beam diameter [mm]	Base	Beam spread
TEDI MAXX LED GU10-WW	<b>23412</b>	5905339234124	9	65	900	3000	120	GU10	F	
TEDI MAXX LED GU10-CW	<b>23413</b>	5905339234131	9	65	900	6000	120	GU10	F	
TEDI MAXX LED GU10-NW	<b>23414</b>	5905339234148	9	65	900	4000	120	GU10	F	



# Kanlux ZUBI LED

LED-LEUCHTMITTEL ► LED LIGHT SOURCE

NEW



ZUBI LED 4W G9



ZUBI LED 4W E14



Kanlux ZUBI LED ist eine energieeffiziente LED-Lichtquelle. Der hohe Lichtstrom von 520 lm und die geringe Größe ermöglichen den Einsatz dieser Quelle in sehr vielen Leuchten. Das Design der Kanlux ZUBI-Quellen garantiert einen breiten Ausleuchtungswinkel, was sie ideal für den Einsatz auch in allen offenen Leuchten und Kronleuchtern macht.

Material: Kunststoff

Kanlux ZUBI LED are energy-saving LED light sources. High luminous flux of 520lm and small size allow this source to be used in many luminaires. The construction of Kanlux ZUBI sources guarantees a wide lighting angle, thanks to which it is ideal for use in all open luminaires and chandeliers.

Material: plastic



ZUBI LED 4W G9-CW	<b>24519</b>	5905339245199	4	42	520	6500	320	G9	≥15000	E
ZUBI LED 4W G9-VVV	<b>24526</b>	5905339245267	4	42	520	3000	320	G9	≥15000	E
ZUBI LED 4W G9-NW	<b>24527</b>	5905339245274	4	42	520	4000	320	G9	≥15000	E
ZUBI LED 4W E14-VVV	<b>24528</b>	5905339245281	4	42	520	3000	320	E14	≥15000	E
ZUBI LED 4W E14-NW	<b>24529</b>	5905339245298	4	42	520	4000	320	E14	≥15000	E

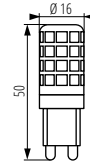

ZUBI LED 4W G9

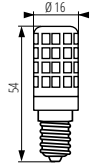

ZUBI LED 4W E14



# Kanlux TANO G4

LED-LEUCHTMITTEL ► LED LIGHT SOURCE



TANO G4 SMD

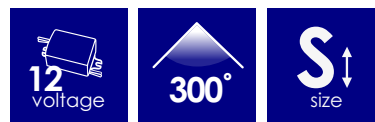

Kanlux TANO ist eine LED-Lichtquelle mit einem G4-Sockel auf der Basis effizienter LEDs. Der Beleuchtungswinkel dieser Quelle beträgt 300°, ihre Lebensdauer beträgt 20.000 Stunden. Die Kanlux TANO G4-Quellen werden mit 12 V Spannung betrieben.

Material: Kunststoff

Kanlux TANO is an LED capsule with a G4 base based on efficient LED diodes. The lighting angle of this source is 300°, its durability is 20,000 hours. Kanlux TANO G4 sources are powered by 12V.

Material: plastic



TANO G4 SMD-WW	<b>14936</b>	5907540962483	1,5	11	100	3000	300	G4	G
TANO G4 SMD-NW	<b>14937</b>	5905339149374	1,5	11	105	4000	300	G4	G

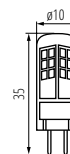

TANO G4 SMD

# Kanlux LED12 G4

LED-LEUCHTMITTEL ► LED LIGHT SOURCE



LED12 G4

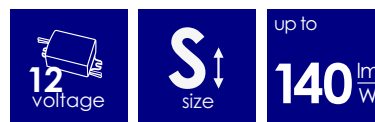

Kanlux LED12 G4 ist eine LED-Kapsel, die auf neuen, sehr effizienten LEDs basiert. Der Leuchtwinkel der LED-Kapsel beträgt 160°, die Lebensdauer 20.000 Stunden und die Leistung bis zu 140 Lumen pro Watt.

Kanlux LED12 G4 is an LED capsule based on new, high-performance LEDs. The source's lighting angle is 120°, its life is 20,000 hours, and the efficiency for NW colour is as much as 140 lm/W.

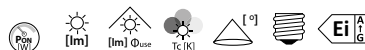

LED12 G4-WW	<b>18502</b>	5905339185020	1,2	165	135	3000	120	G4	E
LED12 G4-NW	<b>18503</b>	5905339185037	1,2	170	140	4000	120	G4	E

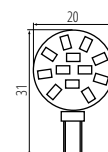

LED12 G4



# IQ-LED AR-111

LED-LEUCHTMITTEL ► LED LIGHT SOURCE



IQ-LED AR-111 13W

			[W]	[lm]	[lm] Φ <sub>use</sub>	T <sub>c</sub> [K]	[°]		[lm/W]	
IQ-LED AR-111 13W-WW	<b>35252</b>	5905339352521	13	107	1050	950	2700	40	G53	G
IQ-LED AR-111 13W-NW	<b>35253</b>	5905339352538	13	107	1050	950	4000	40	G53	G

12 AC 50Hz; 12 DC	AR-111	SMD	90°	≤ 6x Maxd <sub>dim</sub>	97	≥ 40000	45000					

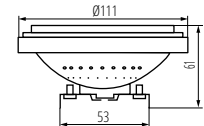

IQ-LED AR-111 13W



Kanlux IQ-LED AR-111 LED ist eine LED-Version älterer 12V-Halogenlampen. Sie zeichnen sich durch eine lange Lebensdauer (45.000 Stunden), 5 Jahre Garantie und niedrigen Energieverbrauch aus. Wir empfehlen diese Lichtquelle überall dort, wo sie sichtbar ist - wegen ihres dekorativen Werts. Kanlux IQ-LED AR-111 zeichnen sich außerdem durch einen sehr hohen Farbwiedergabeindex Ra > 97 aus.

5 Jahre Garantie gemäß den Bedingungen der Garantieerklärung, die auf der Website verfügbar ist

Abdeckungsmaterial: Kunststoff

Kanlux IQ LED AR-111 LED is a LED version of older 12V halogen sources. They are characterized by a long lifetime (45,000 hours), 5 Year warranty and low energy consumption. We recommend this light source wherever it is visible - due to its decorative value. Kanlux IQ-LED AR-111 are also distinguished by a very high Color Rendering Index Ra > 97.

5 years Warranty under the terms of the warranty statement, available on our website

Lampshade material: plastic

# IQ-LED ES-111

LED-LEUCHTMITTEL ► LED LIGHT SOURCE



IQ-LED ES-111 12W

			[W]	[lm]	[lm] Φ <sub>use</sub>	T <sub>c</sub> [K]	[°]		[lm/W]	
IQ-LED ES-111 12W-WW	<b>27318</b>	5905339273185	12	84	950	800	2700	40	GU10	G
IQ-LED ES-111 12W-NW	<b>27319</b>	5905339273192	12	92	1050	850	4000	40	GU10	G

220-240 AC	50	ES-111	SMD	90°	97	≥ 40000	45000					

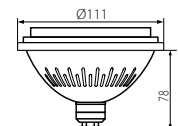

IQ-LED ES-111 12W



Kanlux IQ-LED ES-111 sind moderne LED-Leuchtmittel, die sich durch einen sehr hohen Farbwiedergabeindex Ra > 97 auszeichnen. Wie die gesamte IQ-LED-Serie sind auch Kanlux IQ-LED ES-111 vom TÜV Rheinland zertifiziert, was ihre Sicherheit bestätigt. Die Lebensdauer des Produkts beträgt 45.000 Stunden, so dass wir eine 5-Jahres-Garantie für diese Lampen geben können. Außerdem können die Kanlux IQ-LED ES-111-Lampen mit Dimmern kooperieren.

5 Jahre Garantie gemäß den Bedingungen der Garantieerklärung, die auf der Website verfügbar ist

Abdeckungsmaterial: Kunststoff

Kanlux IQ-LED ES-111 are modern LED light sources, which are characterized by a very high color rendering index Ra > 97. The product has a lifetime of 45,000 hours, which allows us to provide a 5-year warranty on these sources. Additionally, Kanlux IQ-LED ES-111 sources can cooperate with dimmers.

5 years Warranty under the terms of the warranty statement, available on our website

Lampshade material: plastic

**Kanlux**

# IQ-LED EX T8

LED-LEUCHTMITTEL ▶ LED LIGHT SOURCE

**NEW**



IQ-LED EX T8 12W



**5**  
WARRANTY  
5 years

up to  
**210** lm  
/ W

**PF > 0.9**  
high

**GLASS**  
tube

Kanlux IQ-LED EX T8 sind eine neue Lichtquelle der bekannten Premiumlinie der T8-Versionen. Sie basieren auf Hochleistungs-LEDs, die in einem milchigen Glaskörper untergebracht sind und das Licht gleichmäßig abstrahlen. Die IQ-LED EX T8-Lampen zeichnen sich durch hohe Verarbeitungsqualität und erstklassige Komponenten aus: 5 Jahre Garantie, 50.000 Stunden Lebensdauer und eine extreme Lichtausbeute von bis zu 210 Lumen pro Watt.

5 Jahre Garantie gemäß den Bedingungen der Garantieerklärung, die auf der Website verfügbar ist

Abdeckungsmaterial: Glas

Kanlux IQ-LED EX T8 is a new light source of the well-known premium line of the T8 version. They use highly efficient LEDs housed in a milky glass luminaire to emit light evenly. The high-quality workmanship and attention to top-class components of the IQ-LED EX T8 lamps result in: a 5-year warranty, 50,000 hours of service life and an extreme luminous efficacy of up to 210 Lumens per Watt.

5 years Warranty under the terms of the warranty statement, available on our website

Lampshade material: glass

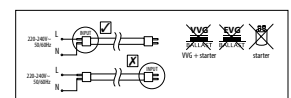

OR

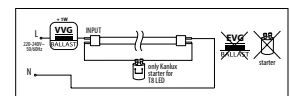

IQ-LED EX T8 12W-NW	<b>35254</b>	5905339352545	12	2520	4000	200	G13	A
IQ-LED EX T8 12W-CW	<b>35255</b>	5905339352552	12	2520	6500	200	G13	A

**[V]**  
220-240 AC

**[Hz]**  
50

**T8 LED**

**SMD**

**360°**  
Φuse

**≤ 6/MaxAdam**

**80**  
Ra

**≥ 50000**

**50000**

**Hg**

**ONE SIDE INPUT**

**CE**

**ERC**

**UK**

**⌚**

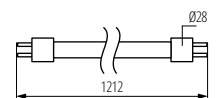

ZUBEHÖR ▶ ACCESSORIES

T8 LED STARTER | **26069** | 5905339260697 Ersatz-LED-Starter (26069) | Replacement LED light switch (26069)

IQ-LED EX T8 12W

# T8 LED GLASSv3

LED-LEUCHTMITTEL ► LED LIGHT SOURCE



up to **140**  $\frac{\text{lm}}{\text{W}}$

IC driver

GLASS tube

Kanlux T8 LED GLASS ist eine bekannte und bewährte Linie von Leuchtstofflampen, die auf den Hochleistungs-SMD-LED's basiert, die in einem Milch-Glaskörper untergebracht sind. Hohe Fertigungsqualität und die besten Komponenten sind die wichtigsten Merkmale der Leuchtstofflampen T8 LED GLASSv3.

Abdeckungsmaterial: Glas

The Kanlux T8 LED GLASS is a well-known and proven line of fluorescent lamps utilising high-performance SMD LED's in a milky-coloured glass body. The high quality of workmanship and the care taken over choosing the best-quality components are the most-important features of the T8 LED GLASSv3.

Lampshade material: glass



T8 LED GLASSv3



T8 LED GLASSv3 9W-NW	<b>26062</b>	5905339260628	9	1260	4000	250	≥15000	G13	D
T8 LED GLASSv3 9W-CW	<b>26063</b>	5905339260635	9	1260	6500	250	≥15000	G13	D
T8 LED GLASSv3 18W-NW	<b>26064</b>	5905339260642	18	2520	4000	250	≥15000	G13	D
T8 LED GLASSv3 18W-CW	<b>26065</b>	5905339260659	18	2520	6500	250	≥15000	G13	D
T8 LED GLASSv3 22W-NW	<b>26058</b>	5905339260581	22	3080	4000	250	≥25000	G13	D
T8 LED GLASSv3 22W-CW	<b>26059</b>	5905339260598	22	3080	6500	250	≥25000	G13	D

[V] 220-240 AC	[Hz] 50	T8 LED	SMD	360° Φuse	≤6° ellipse ≤6° MacAdam	Ra 80	[h] 25000	Hg
		L N ONE SIDE INPUT		CE	ERC	UK CA		

ZUBEHÖR ► ACCESSORIES

T8 LED STARTER | **26069** | 5905339260697 Ersatz-LED-Starter (26069) | Replacement LED light switch (26069)



T8 LED GLASSv3 9W

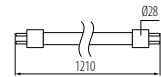

T8 LED GLASSv3 18W

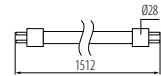

T8 LED GLASSv3 22W

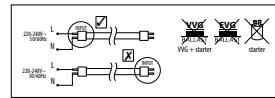

OR

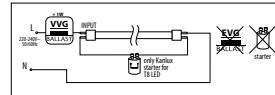

# T8 LED GLASSv3T

LED-LEUCHTMITTEL ► LED LIGHT SOURCE



up to **145**  $\frac{\text{lm}}{\text{W}}$

IC driver

GLASS tube

Kanlux T8 LED GLASS ist eine bekannte und bewährte Linie von Leuchtstofflampen, die auf Hochleistungs-LEDs SMD basiert. Kanlux T8 LED GLASSv3T ist im transparenten Glaskörper untergebracht. Die neuen Modelle haben eine höhere Lichtausbeute und einen engeren Abstrahlwinkel von 120°.

Einseitige Stromversorgung der LED-Leuchtröhren

Abdeckungsmaterial: Glas

The Kanlux T8 LED GLASS is a well-known and proven line of fluorescent lamps utilising high-performance SMD LED's. The Kanlux T8 LED GLASSv3T is fitted in a transparent glass body. The new models have a higher luminous efficacy and the narrower light-emission angle of 120°.

One-way fluorescent LED-power supply

Lampshade material: glass



T8 LED GLASSv3T



T8 LED GLASSv3T 18W NW	<b>26068</b>	5905339260680	18	2610	4000	120	G13	D
------------------------	--------------	---------------	----	------	------	-----	-----	---

[V] 220-240 AC	[Hz] 50	T8 LED	SMD	360° Φuse	≤6° ellipse ≤6° MacAdam	Ra 80	[h] ≥15000	25000
		L N ONE SIDE INPUT		CE	ERC	UK CA		

ZUBEHÖR ► ACCESSORIES

T8 LED STARTER | **26069** | 5905339260697 Ersatz-LED-Starter (26069) | Replacement LED light switch (26069)

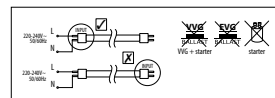

OR

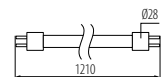
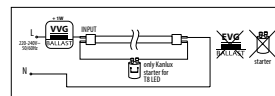

T8 LED GLASSv3T

Kanlux

# T8 LED GLASSv4

LED-LEUCHTMITTEL ▶ LED LIGHT SOURCE



3  
 WARRANTY  
 3 years

up to  
160 lm/W

PF >0,9  
 high

GLASS  
 tube

Kanlux T8 LED GLASS V4 ist eine bekannte und bewährte Linie von Leuchtstofflampen, die auf hocheffizienten Leistungs-LED's basiert. Die T8 LED GLASS V4 ist in einem milchigen Glaskörper untergebracht. Hohe Fertigungsqualität und die besten Komponenten sind die wichtigsten Merkmale der Leuchtstofflampen T8 LED GLASSV4. Darüber hinaus haben diese einzigartigen T8 LED GLASS V4 eine 3-jährige Garantie und eine Lichtausbeute von bis zu 160 Lumen pro Watt.

Einseitige Stromversorgung der LED-Leuchtröhren

3 Jahre Garantie gemäß den Bedingungen der Garantieerklärung, die auf der Website verfügbar ist

Abdeckungsmaterial: Glas

Kanlux T8 LED GLASS is a well-known and proven line of fluorescent lamps based on high-performance LED diodes, which are placed in a milky, glass body, thanks to which they evenly emit light. High-quality workmanship and care for the best-class components are the most important features of Kanlux T8 LED GLASSv4. In addition, these unique LED lamps have a 3-year warranty and a luminous efficacy of up to 160 lumens from Watt.

One-way fluorescent LED-power supply

3 years Warranty under the terms of the warranty statement, available on our website

Lampshade material: glass



T8 LED GLASSv4

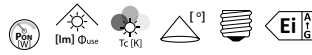

T8 LED GLASSv4 9W-NW	<b>33210</b>	5905339332103	9	1440	4000	220	G13	C
T8 LED GLASSv4 9W-CW	<b>33211</b>	5905339332110	9	1440	6500	220	G13	C
T8 LED GLASSv4 18W-NW	<b>33212</b>	5905339332127	18	2880	4000	220	G13	C
T8 LED GLASSv4 18W-CW	<b>33213</b>	5905339332134	18	2880	6500	220	G13	C
T8 LED GLASSv4 24W-NW	<b>33214</b>	5905339332141	24	3840	4000	220	G13	C
T8 LED GLASSv4 24W-CW	<b>33215</b>	5905339332158	24	3840	6500	220	G13	C

[V] 220-240 AC	[Hz] 50	T8 LED	SMD	360° Φ <sub>use</sub>	ellipse ≤ 6° MacAdam
Ra 80	≥30000	30000	Hg	UV	UV
ONE SIDE INPUT	-10+40	CE	ERC	UK	CA

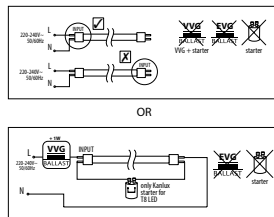

ZUBEHÖR ▶ ACCESSORIES

T8 LED STARTER | **26069** | 5905339260697 Ersatz-LED-Starter (26069) | Replacement LED light switch (26069)

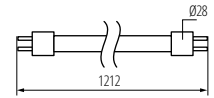

T8 LED GLASSv4 18W

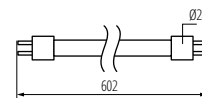

T8 LED GLASSv4 9W

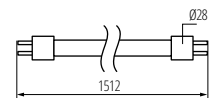

T8 LED GLASSv4 24W

Kanlux

# T8 LED GLASSv5

LED-LEUCHTMITTEL ▶ LED LIGHT SOURCE



T8 LED GLASSv5

4  
 WARRANTY  
 4 years

up to  
185 lm/W

PF >0,9  
 high

GLASS  
 tube

Kanlux T8 LED GLASS v5 ist die nächste Version der bekannten Leuchtstofflampenreihe. Sie basieren auf hocheffizienten LEDs, die in einem milchigen Glaskörper untergebracht sind und das Licht gleichmäßig abstrahlen. Die hochwertige Verarbeitung und die Aufmerksamkeit für erstklassige Komponenten der T8 LED GLASSv5-Lampen bedeuten 4 Jahre Garantie und eine Lichtausbeute von bis zu 185 Lumen pro Watt.

4 Jahre Garantie gemäß den Bedingungen der Garantieerklärung, die auf der Website verfügbar ist

Abdeckungsmaterial: Glas

Kanlux T8 LED GLASS v5 is another version of the well-known line of LED tubes. They are based on high-efficiency LEDs, which are placed in a milky glass body and emit light evenly. High quality finish and care for the best-class components of T8 LED GLASSv5 tubes that's 4-year warranty and luminous efficiency of up to 185 lumens per Watt.

4 years Warranty under the terms of the warranty statement, available on our website

Lampshade material: glass

T8 LED GLASSv5 12W-NW	<b>33216</b>	5905339332165	12	2220	4000	200	G13	B
T8 LED GLASSv5 12W-CW	<b>33217</b>	5905339332172	12	2220	6500	200	G13	B

[V] 220-240 AC	[Hz] 50	T8 LED	SMD	360° Φ <sub>use</sub>	ellipse ≤ 6° MacAdam	Ra 80	≥50000	40000
Hg	UV	UV	ONE SIDE INPUT	-10+40	CE	ERC	UK	CA

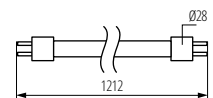
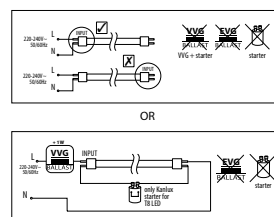

T8 LED GLASSv5 12W

ZUBEHÖR ▶ ACCESSORIES

T8 LED STARTER | **26069** | 5905339260697 Ersatz-LED-Starter (26069) | Replacement LED light switch (26069)

# Kanlux TOMI LED

LED-LEUCHTMITTEL ► LED LIGHT SOURCE



TOMI LED 5W MR16; 7W MR16

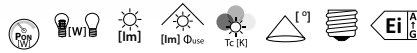

Model	Code	Part No.	P	W	lm	Φuse	Tc [K]	α°	Beam	Base	Efficiency
TOMI LED 5W MR16-WW	22704	5905339227041	5	26	370	300	3000	120	Gx5,3	G	
TOMI LED 5W MR16-CW	22705	5905339227058	5	27	390	310	5300	120	Gx5,3	G	
TOMI LED 7W MR16-WW	22706	5905339227065	7	35	570	470	3000	120	Gx5,3	G	
TOMI LED 7W MR16-CW	22707	5905339227072	7	35	580	480	5300	120	Gx5,3	G	



Kanlux TOMI LED ist ein nachhaltiges LED-Leuchtmittel Typ MR16 im klassischem Design. Beim Leuchtmittel Kanlux TOMI LED wurde eine hybride Kühlkörper-Konstruktion verwendet (Thermoplastschicht + Aluminiumeinsatz), wodurch der Wärmeaustausch mit der Umgebung wesentlich effizienter ist. Die Lebensdauer beträgt 25.000 h. Das matte Glas verteilt das Licht gleichmäßig und der Ausstrahlungswinkel beträgt 120°.

Abdeckungsmaterial: Kunststoff

Kanlux TOMI LED are MR16 type solid LED sources of classic look. Kanlux TOMI LED sources use hybrid heat sink construction thanks to which heat exchange with the environment is much more effective. The matt glass evenly diffuses the light with its illumination angle amounting to 120°.

Lampshade material: plastic

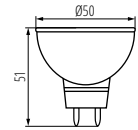

TOMI LED 5W MR16

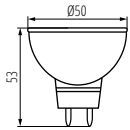

TOMI LED 7W MR16

# Kanlux SIGO LED

LED-LEUCHTMITTEL ► LED LIGHT SOURCE



SIGO R39 LED E14

SIGO R50 LED E14

SIGO R63 LED E27

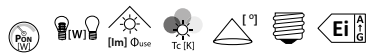

Model	Code	Part No.	P	W	lm	Φuse	Tc [K]	α°	Beam	Base	Efficiency
SIGO R39 LED E14-WW	22733	5905339227331	4	29	320	3000	120	E14	G		
SIGO R39 LED E14-NW	22734	5905339227348	4	29	320	4000	120	E14	G		
SIGO R50 LED E14-WW	22735	5905339227355	6	41	490	3000	120	E14	G		
SIGO R50 LED E14-NW	22736	5905339227362	6	41	490	4000	120	E14	G		
SIGO R63 LED E27-WW	22737	5905339227379	8	54	720	3000	120	E27	F		
SIGO R63 LED E27-NW	22738	5905339227386	8	54	720	4000	120	E27	F		

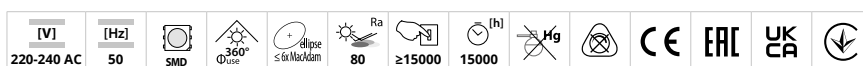

Kanlux SIGO LED ist nicht nur energieeffizient, sondern auch 25-mal langlebiger als herkömmliche Reflektorlampen. Da ihre Form und Größe Standard-Reflektorlampen ähnelt, können sie ohne zusätzliche Modifikationen leicht ausgetauscht werden.

Abdeckungsmaterial: Kunststoff

Kanlux SIGO LED is both energy-efficient and 25 times more durable than traditional reflector bulbs. Since their shape and size resembles standard reflector bulbs, they are easily replaceable without additional modifications.

Lampshade material: plastic

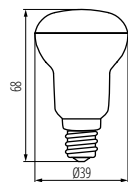

SIGO R39 LED E14

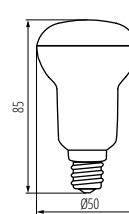

SIGO R50 LED E14

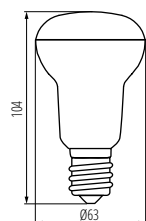

SIGO R63 LED E27

# Kanlux ESG LED

LED-LEUCHTMITTEL ► LED LIGHT SOURCE



ESG LED 9W GX53



Kanlux ESG LED zeichnet sich durch ästhetisches Design und langlebige Konstruktion aus. Der matte Lampenschirm garantiert eine gleichmäßige und breite Lichtverteilung. Das weiße Gehäuse aus Aluminium sorgt für eine gute Wärmeableitung und die leistungsstarken SMD-LEDs zeichnen sich durch eine Lebensdauer von 20.000 Stunden aus.

Material: Aluminiumlegierung, Kunststoff

Kanlux ESG LED is characterised by aesthetic design and durable construction. The matte shade guarantees an even and wide light distribution. White housing made of aluminium ensures proper heat dissipation and high performance SMD LEDs ensure durability for 20.000 h.

Material: aluminum alloy, plastic

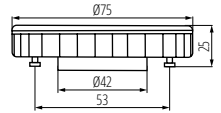

ESG LED 9W GX53

ESG LED 9W GX53-VVV	<b>22422</b>	5905339224224	9	720	595	3000	110	GX53	G
ESG LED 9W GX53-NVV	<b>22423</b>	5905339224231	9	750	600	4000	110	GX53	G
ESG LED 9W GX53-CVV	<b>22424</b>	5905339224248	9	750	600	6000	110	GX53	G

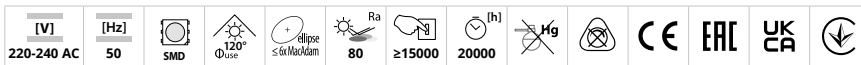

# Kanlux RANGO LED

LED-LEUCHTMITTEL ► LED LIGHT SOURCE



RANGO R7S SMD



RANGO MINI R7S SMD-WW



Die LED-LEUCHTMITTEL Kanlux RANGO ist die ideale energiesparende Lösung für alle Arten von Leuchten und Lichtfluter mit R7s-Sockel.

Material: Kunststoff

Abdeckungsmaterial: Glas

LED source Kanlux RANGO is the perfect energy-saving solution for all types of lamps and floodlights with R7s screw.

Material: plastic

Lampshade material: glass

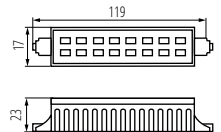

RANGO R7S SMD

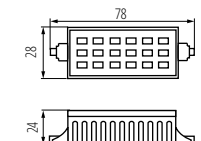

RANGO MINI R7S SMD

RANGO R7S SMD-WW	<b>15098</b>	5907540962155	6	640	550	3000	110	R7s	F
RANGO MINI R7S SMD-WW	<b>15099</b>	5907540962568	6	600	510	3000	110	R7s	F

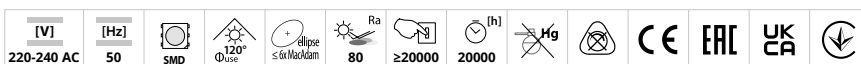

# Kanlux MODv2 LED

LED-LEUCHTMITTEL ▶ LED LIGHT SOURCE



Kanlux MOD LED ist eine professionelle Serie von LED-Modulen, die zur Modifizierung von Leuchten dient, die mit einer alten Art von Glühlampen betrieben werden. Das Modul ist einfach zu montieren. Kanlux MOD LED sind hochwertige SMD-LEDs, die sich durch Energieeffizienz und einer langen Lebensdauer auszeichnen.

Abdeckungsmaterial: Kunststoff

Kanlux MOD LED is a professional series of LED modules designed for modification of lamps which used the old type of light bulbs. The module can be installed easily. Kanlux MOD LED are high-quality SMD LEDs, distinguished by energy efficiency and long lifetime.

Lampshade material: plastic

MODv2 LED 12W



MODv2 LED 12W

MODv2 LED 19W

NICHT VERFÜGBAR FÜR DEN DEUTSCHEN MARKT

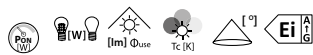

MODv2 LED 12W-WW	29300	5905339293008	12	82	1200	3000	170	F
MODv2 LED 12W-NW	29301	5905339293015	12	82	1200	4000	170	F
MODv2 LED 19W-WW	29302	5905339293022	19	120	2000	3000	170	F
MODv2 LED 19W-NW	29303	5905339293039	19	120	2100	4000	170	E

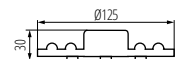

MODv2 LED 12W

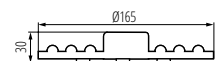

MODv2 LED 19W

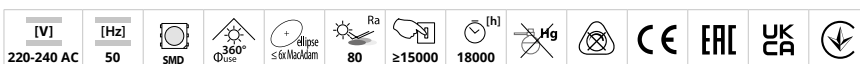

# Kanlux LEDS-B

LED-STREIFEN ► LED TAPE



LEDS-B 4.8W/M IP65



Kanlux LEDS-B sind moderne Dekorstreifen. Ideal für den häuslichen Gebrauch, wo sie einzigartige Arrangements bilden können, die nur durch unsere Vorstellungskraft begrenzt sind. Sie zeichnen sich durch hohe Flexibilität, gute Haftung und hohe Lebensdauer aus. Je nach Ort, den wir ausleuchten oder in dem wir die Lichtakzente setzen möchten, können wir die uns gewünschte und entsprechende Lichtfarbe wählen.

Kanlux LEDS-B are modern strips of decorative character. Perfect for home use where they can create unique arrangements limited by our imagination only. They are characterised by high flexibility, good adhesion and high durability. Depending on the place in which we want to add more light or which we wish to highlight, we can choose the light colour suiting our preferences.

			[lm]	Φ <sub>use</sub>	T <sub>c</sub> (K)					
LEDS-B 4,8W/M IP65-WW	<b>24513</b>	5905339245137	0,5m = 2,4	0,5m = 200	3000	65	5000	G		
LEDS-B 4,8W/M IP65-NW	<b>24514</b>	5905339245144	0,5m = 2,4	0,5m = 220	4000	65	5000	G		
LEDS-B 4,8W/M IP65-CW	<b>24515</b>	5905339245151	0,5m = 2,4	0,5m = 225	6500	65	5000	F		
LEDS-B 4,8W/M IP00-WW	<b>24516</b>	5905339245168	0,5m = 2,4	0,5m = 225	3000	00	5000	F		
LEDS-B 4,8W/M IP00-NW	<b>24517</b>	5905339245175	0,5m = 2,4	0,5m = 235	4000	00	5000	F		
LEDS-B 4,8W/M IP00-CW	<b>24518</b>	5905339245182	0,5m = 2,4	0,5m = 250	6500	00	5000	F		

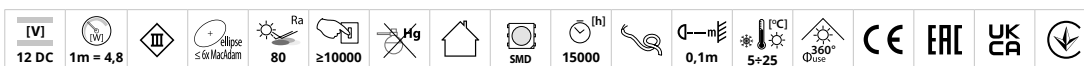

## ZUBEHÖR ► ACCESSORIES

CONNECTOR 8	<b>19030</b>	5905339190307	LED-Streifenverbinder, CONNECTOR 8 (19030)   LED band connector, CONNECTOR 8 (19030)
CONNECTOR 8-CP	<b>19032</b>	5905339190321	LED-Streifenverbinder, CONNECTOR 8-CP (19032)   LED band connector, CONNECTOR 8-CP (19032)
CONNECTOR 8-CPC	<b>19033</b>	5905339190338	LED-Streifenverbinder, CONNECTOR 8-CPC (19033)   LED band connector, CONNECTOR 8-CPC (19033)

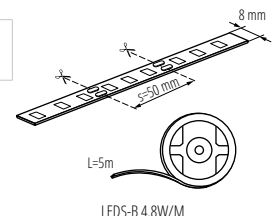



# LED STRIP L60

LED-STREIFEN ▶ LED TAPE



L60 11W/M 12 IP00



L60 11W/M 12 IP00



L60 11W/M 12 IP65



Der LED-Stripe Kanlux L60 ist in zwei Versionen erhältlich - mit Schutzart IP00 und IP65 - für den Einsatz auch an Orten wo es Feuchtigkeit ausgesetzt ist. Die IP65-Version unterscheidet sich in der Größe nicht wesentlich von der IP00-Version - was wichtig für den Einbau in Aluminiumprofile ist. Kanlux L60-Streifen haben einen sehr hohen Farbwiedergabeindex CRI 90 und drei Jahre Garantie. Zusätzlich gibt es die Version Kanlux L60B - eine 30 Meter lange Rolle - für diejenigen, die mehr LED-Streifen benötigen.

3 Jahre Garantie gemäß den Bedingungen der Garantieerklärung, die auf der Website verfügbar ist

Kanlux L60 LED strip that's two IP rates, IP00 and IP65 - for places where the tape is exposed to moisture. IP65 version, does not differ significantly in size from the IP00 version - this is important when mounting in aluminum profiles. Kanlux L60 tapes very high color rendering factor CRI 90 and up to 3 Years warranty. In addition, the Kanlux L60B version is a 30-meter long roll for those who need longer LED strips.

3 years Warranty under the terms of the warranty statement, available on our website

L60 11W/M 12 IP00-WW	<b>33302</b>	5905339333025	0,5m = 5,5	0,5m = 450	3000	00	5000	≤3	G					
L60 11W/M 12 IP00-NW	<b>33303</b>	5905339333032	0,5m = 5,5	0,5m = 450	4000	00	5000	≤3	G					
L60 11W/M 12 IP00-CW	<b>33304</b>	5905339333049	0,5m = 5,5	0,5m = 450	6000	00	5000	≤3	G					
L60B 11W/M 12 IP00-WW	<b>33305</b>	5905339333056	0,5m = 5,5	0,5m = 450	3000	00	30000	≤3	G					
L60B 11W/M 12 IP00-NW	<b>33306</b>	5905339333063	0,5m = 5,5	0,5m = 450	4000	00	30000	≤3	G					
L60 11W/M 12 IP65-WW	<b>33308</b>	5905339333087	0,5m = 5,5	0,5m = 450	3000	65	5000	≤6	G					
L60 11W/M 12 IP65-NW	<b>33309</b>	5905339333094	0,5m = 5,5	0,5m = 450	4000	65	5000	≤6	G					
L60 11W/M 12 IP65-CW	<b>33310</b>	5905339333100	0,5m = 5,5	0,5m = 450	6000	65	5000	≤6	G					

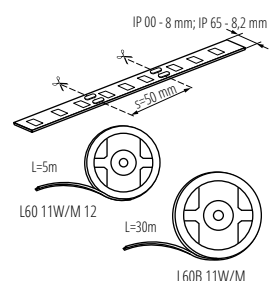

# LED STRIP L120

LED-STREIFEN ▶ LED TAPE



L120 16W/M 24



L120 16W/M 24 IP00



L120 16W/M 24 IP65



+3+  
**WARRANTY**  
3 years

up to  
**120**  $\frac{\text{lm}}{\text{W}}$

**24V**

**3M**  
3M  
tape

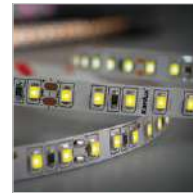

Der LED-Stripe Kanlux L120 ist in zwei Versionen erhältlich - mit Schutzart IP00 und IP65 - für den Einsatz auch an Orten wo es Feuchtigkeit ausgesetzt ist. Die IP65-Version unterscheidet sich in der Größe nicht wesentlich von der IP00-Version - was wichtig für den Einbau in Aluminiumprofile ist. Die Kanlux L120 Streifen zeichnen sich durch eine hohe Lichtausbeute (120 Lumen Watt) und drei Jahre Garantie aus.

3 Jahre Garantie gemäß den Bedingungen der Garantieerklärung, die auf der Website verfügbar ist

Kanlux L120 LED strip that's two IP rates, IP00 and IP65 - for places where the tape is exposed to moisture. IP65 version, does not differ significantly in size from the IP00 version - this is important when mounting in aluminum profiles. Kanlux L120 tapes are high luminous efficiency (120 lm/W) and up to 3 Year warranty.

3 years Warranty under the terms of the warranty statement, available on our website

L120 16W/M 24 IP00-VVV	<b>33311</b>	5905339333117	0,5m = 8	0,5m = 880	3000	00	5000	≤3	F												
L120 16W/M 24 IP00-NVV	<b>33312</b>	5905339333124	0,5m = 8	0,5m = 960	4000	00	5000	≤3	E												
L120 16W/M 24 IP65-VVV	<b>33314</b>	5905339333148	0,5m = 8	0,5m = 800	3000	65	5000	≤6	F												
L120 16W/M 24 IP65-NVV	<b>33315</b>	5905339333155	0,5m = 8	0,5m = 880	4000	65	5000	≤6	F												
L120B 16W/M 24IP00-VVV	<b>33355</b>	5905339333551	0,5m = 8	0,5m = 880	3000	00	30000	≤3	F												
L120B 16W/M 24IP00-NVV	<b>33356</b>	5905339333568	0,5m = 8	0,5m = 960	4000	00	30000	≤3	E												

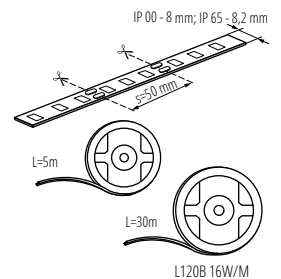

IV

24 DC

1m = 16

III

80

Ra

≥30000

Hg

SMD

30000

0,1m

5+25

360°

IP00

CE

EAC

UK

CA

RoHS

**Kanlux**

# LED STRIP L120 CCT

LED-STREIFEN ▶ LED TAPE



L120 16W/M 12.IP00CCT



Der LED-Stripe Kanlux L120 CCT - das sind drei Lichtfarben (warmweiß, neutralweiß, kaltweiß) in einem Band. Jetzt können Sie die Lichtfarbe je nach Situation und Stimmung ändern, außerdem hat Kanlux L120 CCT einen sehr hohen Farbwiedergabeindex CRI 90 und drei Jahre Garantie.

3 Jahre Garantie gemäß den Bedingungen der Garantieerklärung, die auf der Website verfügbar ist

Kanlux L120 CCT LED strip that's three colors of light in one tape. Now you can change the color of the light depending on the situation and mood, in addition, the Kanlux L120 CCT is a very high color rendering factor CRI 90 and up to 3 Year warranty.

3 years Warranty under the terms of the warranty statement, available on our website  
Proper controller and remote (CTRL 12/24V 10A CCT 22142, REMOTE CCT 22145) available in Kanlux offer are required for correct operation.



L120 16W/M 12.IP00CCT | 33317 | 5905339333179 | 0,5m = 4 (WW/CW) | 0,5m = 330 (WW/CW) | 3000/6000 | 00 | 5000 | G

[V] 12 DC	(IV) 1m = 16	III	ellipse s für Masckdam	Ra 90	≥30000	1kg	house icon	SMD
(h) 30000	0,1m	5÷25	360° Φuse	CE	ERL	UK	down arrow	

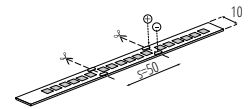

L120 16W/M 12.IP00CCT

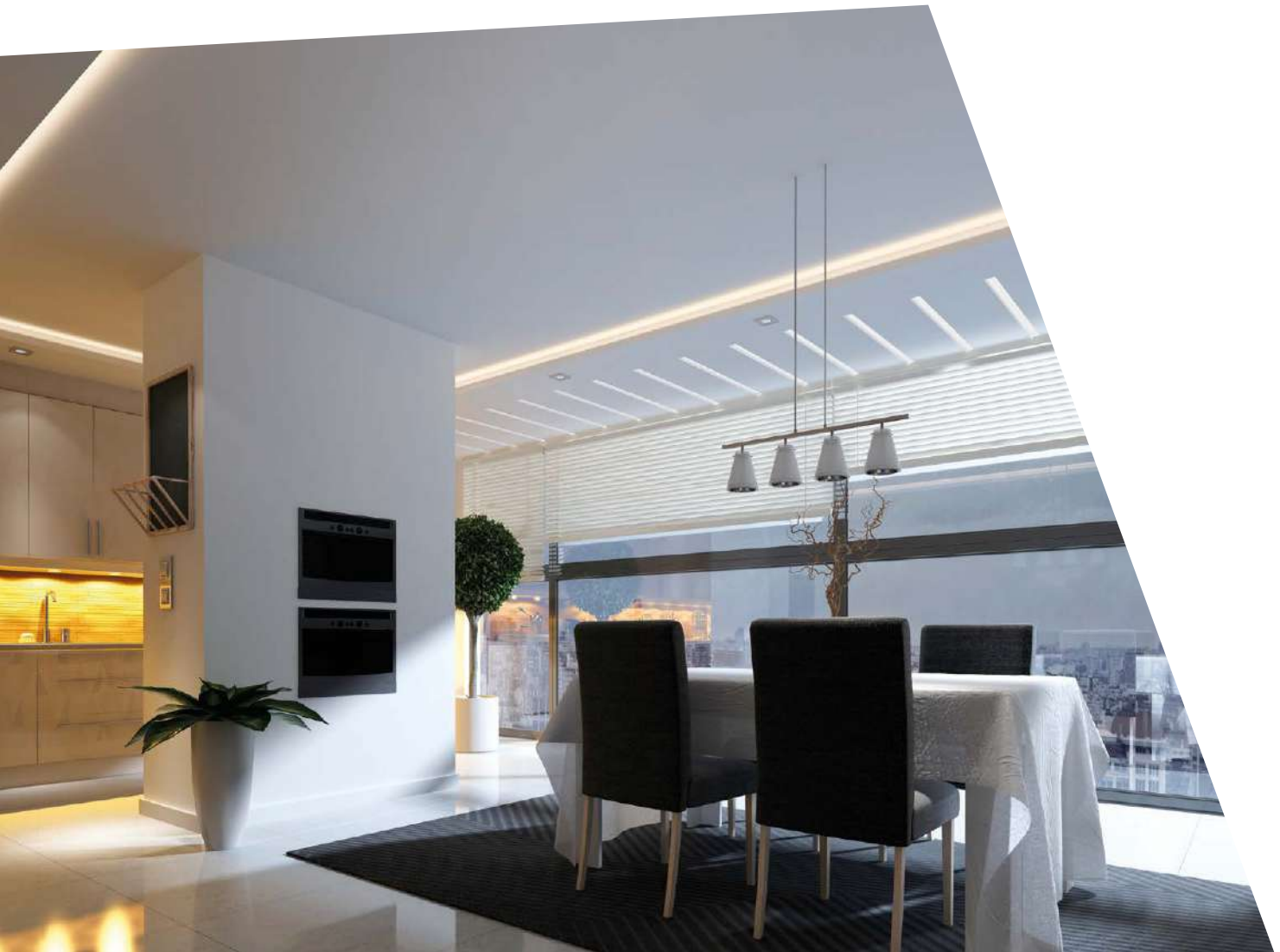

# LED STRIP LCOB 12V

LED-STREIFEN ▶ LED TAPE



LCOB 8W/M 12 IP00-WW



Kanlux LCOB 8W LED-Streifen ist eine einzigartige Beleuchtung, die eine hohe Lichtausbeute und eine 3-jährige Garantie hat. Sein einzigartiges Merkmal ist eine kontinuierliche Lichtlinie - es gibt keine helleren oder dunkleren Stellen auf ihm, keine Lichtpunkte sind im ganzen Band sichtbar. Das Kanlux LCOB-Band gibt ein gleichmäßiges Licht ab, unabhängig von der Profiltiefe und der Transparenz des Schirms. Um den besten Effekt zu erzielen, empfehlen wir die Verwendung von 12V-LED-Bändern in Abschnitten, die nicht länger als 2 Meter sind.

3 Jahre Garantie gemäß den Bedingungen der Garantieerklärung, die auf der Website verfügbar ist

Kanlux LCOB 8W LED strip is a unique lighting, which has a high luminous efficiency and a 3-year warranty. Its unique feature is a continuous line of light - there are no brighter or darker places on it, no points of light are visible in whole strip. The Kanlux LCOB tape emits uniform light regardless of the profile depth and the transparency of the shade. For the best effect, we recommend using 12V LED strips in sections no longer than 2 meters.

3 years Warranty under the terms of the warranty statement, available on our website



LCOB 8W/M 12 IP00-WW



LCOB 8W/M 12 IP00-NW

LCOB 8W/M 12 IP00-WW	<b>33364</b>	5905339333643	0,5m = 4	0,5m=360	3000	00	5000	G												
LCOB 8W/M 12 IP65-WW	<b>33365</b>	5905339333650	0,5m = 4	0,5m=340	3000	65	5000	G												
LCOB 8W/M 12 IP00-NW	<b>33366</b>	5905339333667	0,5m = 4	0,5m=380	4000	00	5000	G												
LCOB 8W/M 12 IP65-NW	<b>33367</b>	5905339333674	0,5m = 4	0,5m=360	4000	65	5000	G												
LCOB 10W/M 12 IP00-WW	<b>37230</b>	5905339372307	0,5m = 5	0,5m=460	3000	00	5000	F												
LCOB 10W/M 12 IP00-NW	<b>37231</b>	5905339372314	0,5m = 5	0,5m=500	4000	00	5000	F												
LCOB 10W/M 12 IP65-WW	<b>37232</b>	5905339372321	0,5m = 5	0,5m=430	3000	65	5000	G												
LCOB 10W/M 12 IP65-NW	<b>37233</b>	5905339372338	0,5m = 5	0,5m=475	4000	65	5000	F												

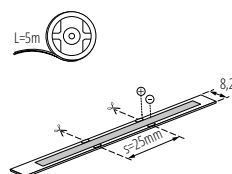

LCOB 8W-M 12 IP65

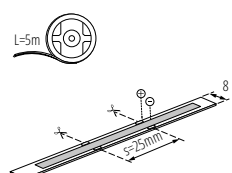

LCOB 8W-M 12 IP00

# LED STRIP LCOB 24V

LED-STREIFEN ▶ LED TAPE



LCOB 10W-M 24



**3**  
WARRANTY  
3 years

**Ra90+**  
true colors

**24V**

**3M**  
3M  
tape

Kanlux LCOB 24V LED-Streifen ist eine einzigartige Beleuchtung. Es hat eine sehr hohe Lichtausbeute und eine 3-Jahres-Garantie. Einzigartig ist, dass es über seine gesamte Länge leuchtet - es gibt keine helleren oder dunkleren Bereiche, keine sichtbaren Lichtpunkte. Das Kanlux LCOB-Band strahlt ein gleichmäßiges Licht aus, unabhängig von der Tiefe des Profils und der Transparenz des Diffusors. Die 24-Volt-Ausführung des Bandes ermöglicht die Verwendung größerer Bandlängen mit dem Anschluss eines Netzteils ohne Beleuchtungsverluste. Das Band ist in zwei Versionen erhältlich: mit IP65- oder IP00-Dichtung.

3 Jahre Garantie gemäß den Bedingungen der Garantieerklärung, die auf der Website verfügbar ist

The Kanlux LCOB 24V LED strip is a unique lighting solution. It has a very high luminous efficacy and a 3-year warranty, its unique feature is that it shines all the way through - there are no brighter or darker areas on it, no visible points of light. The Kanlux LCOB strip emits uniform light regardless of the depth of the profile and the transparency of the diffuser. The 24V version of the strip allows longer pieces to be used with the connection of a single power supply without any loss of luminescence. Two versions of the strip are available: with IP65 or IP00 protection rating.

3 years Warranty under the terms of the warranty statement, available on our website

LCOB 10W/M 24 IP00-WW	<b>33351</b>	5905339333513	0,5m = 5	0,5m=460	3000	00	5000	F					
LCOB 10W/M 24 IP65-WW	<b>33352</b>	5905339333520	0,5m = 5	0,5m=430	3000	65	5000	G					
LCOB 10W/M 24 IP00-CW	<b>33353</b>	5905339333537	0,5m = 5	0,5m=525	6500	00	5000	F					
LCOB 10W/M 24 IP65-CW	<b>33354</b>	5905339333544	0,5m = 5	0,5m=500	6500	65	5000	F					
LCOB 10W/M 24 IP00-NW	<b>33368</b>	5905339333681	0,5m = 5	0,5m=500	4000	00	5000	F					
LCOB 10W/M 24 IP65-NW	<b>33369</b>	5905339333698	0,5m = 5	0,5m=460	4000	65	5000	F					

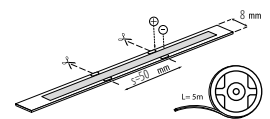

LCOB 10W/M 24 IP00

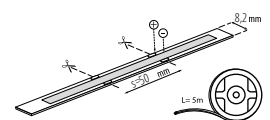

LCOB 10W/M 24 IP65

# LEDS-B RGB

LED-STREIFEN ► LED TAPE



LEDS-B 7.2W/M IP00RGB



Kanlux LEDS-B RGB sind moderne Dekorstreifen. Ideal für den häuslichen Gebrauch, wo sie einzigartige Arrangements bilden können, die nur durch unsere Vorstellungskraft begrenzt sind. Sie zeichnen sich durch hohe Flexibilität, gute Haftung und hohe Lebensdauer aus. Je nach Ort, den wir ausleuchten oder in dem wir Lichtakzente setzen möchten, können wir die uns gewünschte und entsprechende Lichtfarbe wählen.

Kanlux LEDS-B RGB are modern strips of decorative character. Perfect for home use where they can create unique arrangements limited by our imagination only. They are characterised by high flexibility, good adhesion and high durability. Depending on the place in which we want to add more light or which we wish to highlight, we can choose the lighting colour suiting our preferences.

LEDS-B 7,2W/M IP00RGB	<b>24530</b>	5905339245304	0,5m = 3,6	0,5m = 65	00	5000			
LEDS-B 7,2W/M IP65RGB	<b>24531</b>	5905339245311	0,5m = 3,6	0,5m = 65	65	5000			
LEDS-B 7,2W/M IP54RGB	<b>24532</b>	5905339245328	0,5m = 3,6	0,5m = 65	54	5000			



ZUBEHÖR ► ACCESSORIES

CONNECTOR RGB 10-CP	<b>19036</b>	5905339190369	LED-Streifenverbinder, CONNECTOR RGB 10-CP (19036)   LED band connector, CONNECTOR RGB 10-CP (19036)
CONNECTOR RGB 10-CPC	<b>19037</b>	5905339190376	LED-Streifenverbinder, CONNECTOR RGB 10-CPC (19037)   LED band connector, CONNECTOR RGB 10-CPC (19037)
CONNECTOR RGB 10	<b>19038</b>	5905339190383	LED-Streifenverbinder, CONNECTOR RGB 10 (19038)   LED band connector, CONNECTOR RGB 10 (19038)
CONTROLLER LED RGB-RF	<b>22140</b>	5905339221407	RGB-Controller + Fernbedienung, CONTROLLER LED RGB-RF (22140)   Controller RGB + remote control, CONTROLLER LED RGB-RF (22140)

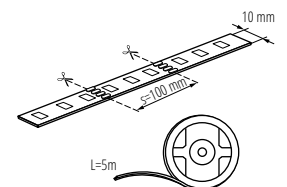

LEDS-B 7,2 W-M P100 RGB; IP65RGB; IP54RGB

# LED STRIP L48 RGBW

LED-STREIFEN ▶ LED TAPE



L48 9W/M 24 IP00-RGBW



Kanlux L48 ist ein RGBW-Stripe, mit dem Sie die Lichtfarbe beliebig ändern können. Dank ihm zaubern Sie beliebige Lichtinstallationen und schaffen Ihre Wunschatmosfera. Sie können zwischen zwei Versionen wählen - eine mit Schutzart IP00 oder IP65. Die IP65-Version ist für den Einsatz auch an Orten wo es Feuchtigkeit ausgesetzt ist. Diese unterscheidet sich in der Größe nicht wesentlich von der IP00-Version - was wichtig für den problemlosen Einbau in Aluminiumprofile wichtig ist.

3 Jahre Garantie gemäß den Bedingungen der Garantieerklärung, die auf der Website verfügbar ist

Kanlux L48 is a tape that allows you to change the color of the light freely. You will conjure up any light installations and create your dream atmosphere. You can choose between two versions of IP00 and IP65. The IP65 version is designed for places where it can be exposed to moisture, it does not differ significantly in size from the IP00 version - this is important for installation in aluminum profiles, which will not be a problem.

3 years Warranty under the terms of the warranty statement, available on our website

Proper controller and remote (CTRL 12/24V 10A RGBW 22143, REMOTE RGBW 22146) available in Kanlux offer are required for correct operation.

L48 9W/M 24 IP00-RGBW	<b>33318</b>	5905339333186	0,5m = 2,3 (W)	0,5m = 240 (W)	1m = max 600 (RGBW)	00	5000	F										
L48 9W/M 24 IP65-RGBW	<b>33319</b>	5905339333193	0,5m = 2,3 (W)	0,5m = 230 (W)	1m = max 550 (RGBW)	65	5000	F										

24 DC	1m = 9 (RGBW)		RGB + 4000(W)	≤6/Maxdäm	≥30000			
30000		0,1m	5+25					



L48 9W/M 24 IP00-RGBW



L48 9W/M 24 IP65-RGBW

# COB SET

LED-STREIFEN SET ▶ LED KIT



COB SET 3M DIM



Kanlux COB SET ist ein Set, das aus drei Elementen besteht: einem 3 m langen LED-Streifen, einem Netzteil und einem Schalter mit Dimmerfunktion. Es handelt sich um ein gebrauchsfertiges Set, das einfach installiert und an die Steckdose angeschlossen werden kann. Dies ist eine praktische Lösung, mit der Sie eine effektive Beleuchtung hinzufügen können, ohne die Notwendigkeit, Wände für zusätzliche elektrische Leitungen aufzuschneiden.

3 Jahre Garantie gemäß den Bedingungen der Garantieerklärung, die auf der Website verfügbar ist

Kanlux COB SET is a set consisting of three elements: a 3m long LED strip, a power supply and a switch with a dimmer function. It is a ready-to-use set that can be easily installed and connected to the socket. This is a convenient solution that allows you to add effective lighting without the need to cut walls for additional electrical wiring.

3 years Warranty under the terms of the warranty statement, available on our website

COB SET 3m DIM-WW	<b>26326</b>	5905339263261	0,5m = 4	0,5m = 360	3000	00	3000	G									
COB SET 3m DIM-NW	<b>26327</b>	5905339263278	0,5m = 4	0,5m = 380	4000	00	3000	F									

220-240 AC	50	220-240 AC	12 DC	3m=18	90	≥30000		
		30000	0,1m					

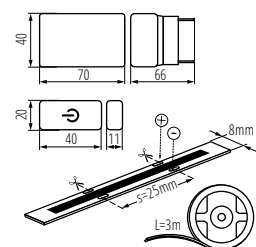

COB SET 3M DIM

# CONTROLLER MONO/CCT

KONTROLER DO TAŠM LED ► CONTROLLER FOR LED TAPES



Dieser Controller arbeitet mit einfarbigen und CCT LED STRIPS, also sowohl mit 1-Kanal-Fernbedienung MONO als auch 4-Kanal-Fernbedienung CCT

Material: Plastik

Contolrer works with one color and CCT LED STRIPS  
1-channel remote MONO  
4-channel remote CCT

Material: plastic



CTRL 12/24V MONO/CCT



REMOTE MONO



REMOTE CCT

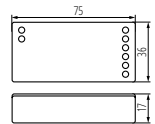

CTRL 12/24V MONO/CCT



CTRL 12/24V MONO/CCT	<b>22147</b>	5905339221476	weiß   white	12 DC; 24 DC	max 10	max 30	<b>NEW</b>
REMOTE MONO	<b>22144</b>	5905339221445	weiß   white	2 x 1,5 DC	2 x AAA	max 30	
REMOTE CCT	<b>22145</b>	5905339221452	weiß   white	2 x 1,5 DC	2 x AAA	max 30	

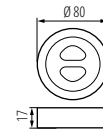

REMOTE MONO

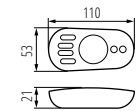

REMOTE CCT

# CONTROLLER RGBW CCT

► CONTROLLER FOR LED TAPES



Der Controller arbeitet mit einfarbigen und RG B / RG BW LED STRIPS. Er kann auch mit RGBCT-Fernbedienungen sowie mit der

4-Kanal-Fernbedienung RGBW arbeiten.

Material: Kunststoff

Contolrer works with one color and RG B/RG BW LED STRI PS. It can work with RGBCT remote controls.

4-channel remote RGBW

Material: plastic



CTRL 12/24V RGBW CCT



REMOTE RGBW



CTRL 12/24V RGBW CCT	<b>22148</b>	5905339221483	weiß   white	12 DC; 24 DC	max 10	max 30	<b>NEW</b>
REMOTE RGBW	<b>22146</b>	5905339221469	weiß   white	2 x 1,5 DC	2 x AAA	max 30	

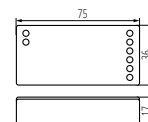

CTRL 12/24V RGBW CCT

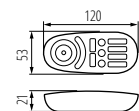

REMOTE RGBW



# PROFILO B

ALUMINIUMPROFIL ► ALUMINIUM PROFILE



PROFILO B

PROFILO B	<b>19161</b>	5905339191618	Eloxiert   anodised	1000	
PROFILO B 2m	<b>26540</b>	5905339265401	Eloxiert   anodised	2000	

ZUBEHÖR ► ACCESSORIES

SHADE B/F-FR	<b>26568</b>	5905339265685	Mattierter Diffusor für Aluminiumprofil, Komplett 10 Stk., SHADE B/F-FR(26568)   Frosted light cover for aluminium profile, package 10 pcs., SHADE B/F-FR(26568)
SHADE B/F-FR 2M	<b>26570</b>	5905339265708	Mattierter Diffusor für Aluminiumprofil, Komplett 10 Stk., SHADE B/F-FR 2M(26570)   Frosted light cover for aluminium profile, package 10 pcs., SHADE B/F-FR 2M(26570)
SHADE B/F-W	<b>26569</b>	5905339265692	Weißer Diffusor für Aluminiumprofil, Komplett 10 Stk., SHADE B/F-W(26569)   White shade for aluminium profile, package 10 pcs., SHADE B/F-W(26569)
SHADE B/F-W 2M	<b>26571</b>	5905339265715	Weißer Diffusor für Aluminiumprofil, Komplett 10 Stk., SHADE B/F-W 2M(26571)   White shade for aluminium profile, package 10 pcs., SHADE B/F-W 2M(26571)
HANDLE B/F	<b>26596</b>	5905339265968	Haltevorrichtung für Aluminiumprofil, HANDLE B/F (26596)   Aluminium profile mounting bracket, HANDLE B/F (26596)
CONNECT-L B	<b>26604</b>	5905339266040	Verbinder für Aluminiumprofil, CONNECT-L B (26604)   Aluminium profile connector, CONNECT-L B (26604)
STOPPER B	<b>19181</b>	5905339191816	Schutzkappe für Aluminiumprofil, STOPPER B (19181)   Aluminium profile cap, STOPPER B (19181)



Oberflächen-Deko-Profil für LED-Lichtstreifen.

Oberflächen Deko-Profil für LED-Lichtstreifen

Set: 10 Stück

Material: Aluminiumlegierung

Small, surface, multi-purpose decorative lighting profile

Material: aluminum alloy

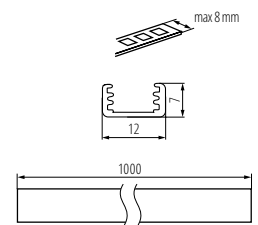

PROFILO B

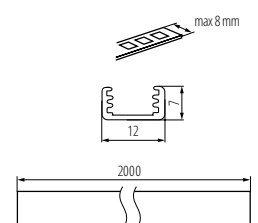

PROFILO B 2M



PROFILO C

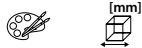

PROFILO C	<b>19162</b>	5905339191625	Eloxiert   anodised	1000
PROFILO C 2m	<b>26541</b>	5905339265418	Eloxiert   anodised	2000

ZUBEHÖR ► ACCESSORIES

SHADE C/D/E/I-FR	<b>26572</b>	5905339265722	Mattierter Diffusor für Aluminiumprofil, Komplett 10 Stk., SHADE C/D/E/I-FR(26572)   Frosted light cover for aluminium profile, package 10 pcs., SHADE C/D/E/I-FR(26572)
SHADE C/D/E/I-FR2M	<b>26573</b>	5905339265739	Mattierter Diffusor für Aluminiumprofil, Komplett 10 Stk., SHADE C/D/E/I-FR2M(26573)   Frosted light cover for aluminium profile, package 10 pcs., SHADE C/D/E/I-FR2M(26573)
SHADE C/D/E/I-W	<b>26574</b>	5905339265746	Weißer Diffusor für Aluminiumprofil, Komplett 10 Stk., SHADE C/D/E/I-W(26574)   White shade for aluminium profile, package 10 pcs., SHADE C/D/E/I-W(26574)
SHADE C/D/E/I-W2M	<b>26575</b>	5905339265753	Weißer Diffusor für Aluminiumprofil, Komplett 10 Stk., SHADE C/D/E/I-W2M(26575)   White shade for aluminium profile, package 10 pcs., SHADE C/D/E/I-W2M(26575)
SHADE CK C/D/E/I-FR	<b>26576</b>	5905339265760	Mattierter Diffusor für Aluminiumprofil, Komplett 10 Stk., SHADE CK C/D/E/I-FR(26576)   Transparent light cover for aluminium profile, package 10 pcs., SHADE CK C/D/E/I-FR(26576)
SHADE CK C/D/E/I-FR2M	<b>26577</b>	5905339265777	Mattierter Diffusor für Aluminiumprofil, Komplett 10 Stk., SHADE CK C/D/E/I-FR2M(26577)   Transparent light cover for aluminium profile, package 10 pcs., SHADE CK C/D/E/I-FR2M(26577)
SHADE CK C/D/E/I-W	<b>26578</b>	5905339265784	Weißer Diffusor für Aluminiumprofil, Komplett 10 Stk., SHADE CK C/D/E/I-W(26578)   White shade for aluminium profile, package 10 pcs., SHADE CK C/D/E/I-W(26578)
SHADE CK C/D/E/I-W2M	<b>26579</b>	5905339265791	Weißer Diffusor für Aluminiumprofil, Komplett 10 Stk., SHADE CK C/D/E/I-W2M(26579)   White shade for aluminium profile, package 10 pcs., SHADE CK C/D/E/I-W2M(26579)
HANDLE C/D/E/I	<b>26597</b>	5905339265975	Haltevorrichtung für Aluminiumprofil, HANDLE C/D/E/I (26597)   Aluminium profile mounting bracket, HANDLE C/D/E/I (26597)
CONNECT C/D/E/I	<b>26563</b>	5905339265630	Verbinder für Aluminiumprofil, CONNECT C/D/E/I(26563)   Aluminium profile connector, CONNECT C/D/E/I(26563)
CONNECT-L C	<b>26562</b>	5905339265623	Verbinder für Aluminiumprofil, CONNECT-L C(26562)   Aluminium profile connector, CONNECT-L C(26562)
STOPPER C	<b>19182</b>	5905339191823	Schutzkappe für Aluminiumprofil, STOPPER C (19182)   Aluminium profile cap, STOPPER C (19182)

slide

click

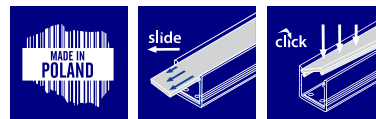

Winkel-Deko-Profil (30° und 60°).

Winkel-Deko-Profil (30° und 60°)  
Set: 10 Stück

Material: Aluminiumlegierung

Angular (30° and 60°) decorative lighting profile

Material: aluminum alloy

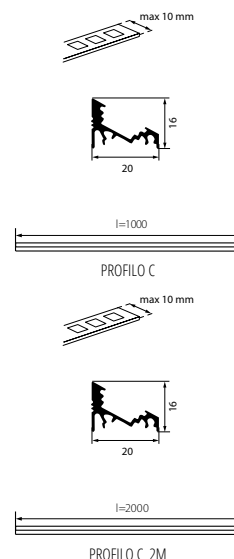

# PROFILO D

ALUMINIUMPROFIL ► ALUMINIUM PROFILE



PROFILO D

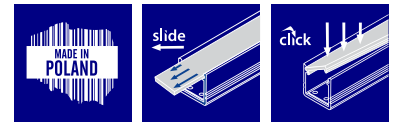

Oberflächen-Deko-Profil für LED-Lichtstreifen.

Oberflächen Deko-Profil für LED-Lichtstreifen

Set: 10 Stück

Material: Aluminiumlegierung

Surface decorative lighting profile

Material: aluminum alloy



PROFILO D	<b>19163</b>	5905339191632	Eloxiert   anodised	1000
PROFILO D 2m	<b>26542</b>	5905339265425	Eloxiert   anodised	2000

## ZUBEHÖR ► ACCESSORIES

SHADE C/D/E/I-FR	<b>26572</b>	5905339265722	Mattierter Diffusor für Aluminiumprofil, Komplett 10 Stk., SHADE C/D/E/I-FR(26572)   Frosted light cover for aluminium profile, package 10 pcs., SHADE C/D/E/I-FR(26572)
SHADE C/D/E/I-FR2M	<b>26573</b>	5905339265739	Mattierter Diffusor für Aluminiumprofil, Komplett 10 Stk., SHADE C/D/E/I-FR 2M(26573)   Frosted light cover for aluminium profile, package 10 pcs., SHADE C/D/E/I-FR 2M(26573)
SHADE C/D/E/I-W	<b>26574</b>	5905339265746	Weißer Diffusor für Aluminiumprofil, Komplett 10 Stk., SHADE C/D/E/I-W(26574)   White shade for aluminium profile, package 10 pcs., SHADE C/D/E/I-W(26574)
SHADE C/D/E/I-W2M	<b>26575</b>	5905339265753	Weißer Diffusor für Aluminiumprofil, Komplett 10 Stk., SHADE C/D/E/I-W 2M(26575)   White shade for aluminium profile, package 10 pcs., SHADE C/D/E/I-W 2M(26575)
SHADE CK C/D/E/I-FR	<b>26576</b>	5905339265760	Mattierter Diffusor für Aluminiumprofil, Komplett 10 Stk., SHADE CK C/D/E/I-FR(26576)   Transparent light cover for aluminium profile, package 10 pcs., SHADE CK C/D/E/I-FR(26576)
SHADE CK C/D/E/I-FR2M	<b>26577</b>	5905339265777	Mattierter Diffusor für Aluminiumprofil, Komplett 10 Stk., SHADE CK C/D/E/I-FR2M(26577)   Transparent light cover for aluminium profile, package 10 pcs., SHADE CK C/D/E/I-FR2M(26577)
SHADE CK C/D/E/I-W	<b>26578</b>	5905339265784	Weißer Diffusor für Aluminiumprofil, Komplett 10 Stk., SHADE CK C/D/E/I-W(26578)   White shade for aluminium profile, package 10 pcs., SHADE CK C/D/E/I-W(26578)
SHADE CK C/D/E/I-W2M	<b>26579</b>	5905339265791	Weißer Diffusor für Aluminiumprofil, Komplett 10 Stk., SHADE CK C/D/E/I-W 2M(26579)   White shade for aluminium profile, package 10 pcs., SHADE CK C/D/E/I-W 2M(26579)
HANDLE C/D/E/I	<b>26597</b>	5905339265975	Haltevorrichtung für Aluminiumprofil, HANDLE C/D/E/I (26597)   Aluminium profile mounting bracket, HANDLE C/D/E/I (26597)
CONNECT C/D/E/I	<b>26563</b>	5905339265630	Verbinder für Aluminiumprofil, CONNECT C/D/E/I(26563)   Aluminium profile connector, CONNECT C/D/E/I(26563)
STOPPER D	<b>19183</b>	5905339191830	Schutzkappe für Aluminiumprofil, STOPPER D (19183)   Aluminium profile cap, STOPPER D (19183)

slide

click

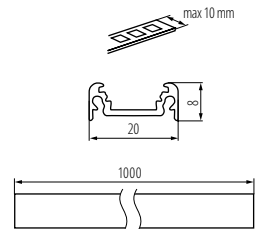

PROFILO D

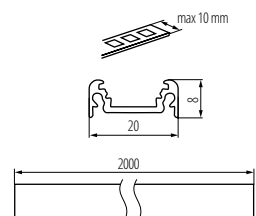

PROFILO D 2M

# PROFILO F

ALUMINIUMPROFIL ► ALUMINIUM PROFILE



PROFILO F

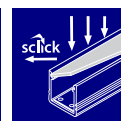

Deko-Profil für LED-Lichtstreifen.

Deko-Profil für LED-Lichtstreifen

Set: 10 Stück

Material: Aluminiumlegierung

Multi-purpose decorative lighting profile

Material: aluminum alloy



PROFILO F	<b>26552</b>	5905339265524	Eloxiert   anodised	1000
PROFILO F 2m	<b>26553</b>	5905339265531	Eloxiert   anodised	2000

## ZUBEHÖR ► ACCESSORIES

SHADE B/F-FR	<b>26568</b>	5905339265685	Mattierter Diffusor für Aluminiumprofil, Komplett 10 Stk., SHADE B/F-FR(26568)   Frosted light cover for aluminium profile, package 10 pcs., SHADE B/F-FR(26568)
SHADE B/F-FR 2M	<b>26570</b>	5905339265708	Mattierter Diffusor für Aluminiumprofil, Komplett 10 Stk., SHADE B/F-FR 2M(26570)   Frosted light cover for aluminium profile, package 10 pcs., SHADE B/F-FR 2M(26570)
SHADE B/F-W	<b>26569</b>	5905339265692	Weißer Diffusor für Aluminiumprofil, Komplett 10 Stk., SHADE B/F-W(26569)   White shade for aluminium profile, package 10 pcs., SHADE B/F-W(26569)
SHADE B/F-W 2M	<b>26571</b>	5905339265715	Weißer Diffusor für Aluminiumprofil, Komplett 10 Stk., SHADE B/F-W 2M(26571)   White shade for aluminium profile, package 10 pcs., SHADE B/F-W 2M(26571)
HANDLE B/F	<b>26596</b>	5905339265968	Haltevorrichtung für Aluminiumprofil, HANDLE B/F (26596)   Aluminium profile mounting bracket, HANDLE B/F (26596)
STOPPER F	<b>26590</b>	5905339265906	Schutzkappe für Aluminiumprofil, STOPPER F (26590)   Aluminium profile caps, STOPPER F (26590)

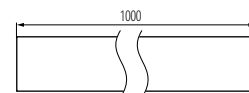

PROFILO F

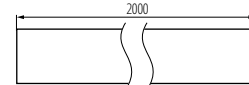

PROFILO F 2M

# PROFILO G

ALUMINIUMPROFIL ► ALUMINIUM PROFILE



PROFILO G



Einbau-Deko-Profil für LED-Lichtstreifen.

Einbau-Deko-Profil für LED-Lichtstreifen

Set: 10 Stück

Material: Aluminiumlegierung

Recessed decorative lighting profile

Material: aluminum alloy



PROFILO G	<b>26558</b>	5905339265586	Eloxiert   anodised	1000
PROFILO G 2m	<b>26559</b>	5905339265593	Eloxiert   anodised	2000

## ZUBEHÖR ► ACCESSORIES

SHADE CK G	<b>26580</b>	5905339265807	Weißer Diffusor für Aluminiumprofil, Komplett 10 Stk., SHADE CK G(26580)   White shade for aluminium profile, package 10 pcs., SHADE CK G(26580)
SHADE CK G 2M	<b>26581</b>	5905339265814	Weißer Diffusor für Aluminiumprofil, Komplett 5 Stk., SHADE CK G 2M(26581)   White shade for aluminium profile, package 5 pcs., SHADE CK G 2M(26581)
HANDLE G	<b>26598</b>	5905339265982	Haltevorrichtung für Aluminiumprofil, HANDLE G (26598)   Aluminium profile mounting bracket, HANDLE G (26598)
STOPPER G	<b>26592</b>	5905339265920	Schutzkappe für Aluminiumprofil, STOPPER G (26592)   Aluminium profile caps, STOPPER G (26592)
SEALINGS G	<b>26602</b>	5905339266026	Dichtung für Aluminiumprofil, SEALINGS G (26602)   Aluminium profile gasket, SEALINGS G (26602)

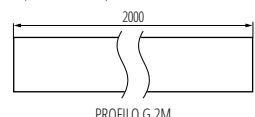
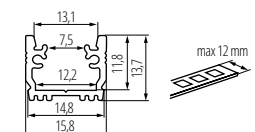
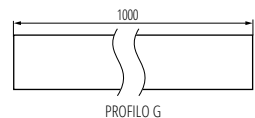
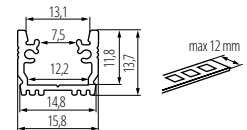

# PROFILO H

ALUMINIUMPROFIL ► ALUMINIUM PROFILE



PROFILO H



Flex-Deko-Profil für LED-Lichtstreifen.

Flex-Deko-Profil für LED-Lichtstreifen

Set: 10 Stück

Material: Aluminiumlegierung

Flexible decorative lighting profile - possibilities of bending in two directions

Material: aluminum alloy



PROFILO H	<b>26560</b>	5905339265609	Eloxiert   anodised	1000
PROFILO H 2m	<b>26561</b>	5905339265616	Eloxiert   anodised	2000

ZUBEHÖR ► ACCESSORIES

SHADE-O H-W	<b>26586</b>	5905339265869	Weißer Diffusor für Aluminiumprofil, Komplett 10 Stk., SHADE-O H-W(26586)   White shade for aluminium profile, package 10 pcs., SHADE-O H-W(26586)
SHADE-O H-W 2m	<b>26587</b>	5905339265876	Weißer Diffusor für Aluminiumprofil, Komplett 5 Stk., SHADE-O H-W 2m(26587)   White shade for aluminium profile, package 5 pcs., SHADE-O H-W 2m(26587)
SHADE-U H-FR	<b>26582</b>	5905339265821	Mattierter Diffusor für Aluminiumprofil, Komplett 10 Stk., SHADE-U H-FR(26582)   Transparent light cover for aluminium profile, package 10 pcs., SHADE-U H-FR(26582)
SHADE-U H-FR 2m	<b>26583</b>	5905339265838	Mattierter Diffusor für Aluminiumprofil, Komplett 5 Stk., SHADE-U H-FR 2m(26583)   Transparent light cover for aluminium profile, package 5 pcs., SHADE-U H-FR 2m(26583)
SHADE-U H-W	<b>26584</b>	5905339265845	Diffusor für Aluminiumprofil, Komplett 10 Stk., SHADE-U H-W(26584)   Shade for aluminium profile, package 10 pcs., SHADE-U H-W(26584)
SHADE-U H-W 2m	<b>26585</b>	5905339265852	Weißer Diffusor für Aluminiumprofil, Komplett 5 Stk., SHADE-U H-W 2m(26585)   White shade for aluminium profile, package 5 pcs., SHADE-U H-W 2m(26585)
HANDLE H	<b>26599</b>	5905339265999	Haltevorrichtung für Aluminiumprofil, HANDLE H (26599)   Aluminium profile mounting bracket, HANDLE H (26599)
HANDLE SIDE H	<b>26600</b>	5905339266002	Haltevorrichtung für Aluminiumprofil, HANDLE SIDE H (26600)   Aluminium profile mounting bracket, HANDLE SIDE H (26600)
STOPPER-U H	<b>26593</b>	5905339265937	Schutzkappe für Aluminiumprofil, STOPPER-U H (26593)   Aluminium profile caps, STOPPER-U H (26593)
STOPPER-O H	<b>26594</b>	5905339265944	Schutzkappe für Aluminiumprofil, STOPPER-O H (26594)   Aluminium profile caps, STOPPER-O H (26594)

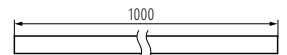
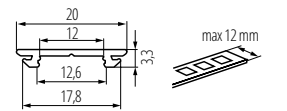

PROFILO H

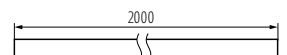
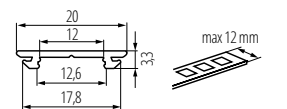

PROFILO H 2M

# PROFILO J

ALUMINIUMPROFIL ► ALUMINIUM PROFILE



PROFILO J



PROFILO J-W



Oberflächen-Deko-Profil für LED-Lichtstreifen.

Oberflächen Deko-Profil für LED-Lichtstreifen

Set: 10 Stück

Material: Aluminiumlegierung

Surface decorative lighting profile

Material: aluminum alloy



PROFILO J	26544	5905339265449	Eloxiert   anodised	1000
PROFILO J 2M	26545	5905339265456	Eloxiert   anodised	2000
PROFILO J-W	26546	5905339265463	weiß   white	1000
PROFILO J-W 2M	26547	5905339265470	weiß   white	2000

## ZUBEHÖR ► ACCESSORIES

SHADE J/K-FR	26564	5905339265647	Mattierter Diffusor für Aluminiumprofil, Komplett 10 Stk., SHADE J/K-FR(26564)   Frosted light cover for aluminium profile, package 10 pcs., SHADE J/K-FR(26564)
SHADE J/K-FR 2m	26566	5905339265661	Mattierter Diffusor für Aluminiumprofil, Komplett 10 Stk., SHADE J/K-FR 2m(26566)   Frosted light cover for aluminium profile, package 10 pcs., SHADE J/K-FR 2m(26566)
SHADE J/K-W	26565	5905339265654	Weißer Diffusor für Aluminiumprofil, Komplett 10 Stk., SHADE J/K-W(26565)   White shade for aluminium profile, package 10 pcs., SHADE J/K-W(26565)
SHADE J/K-W 2m	26567	5905339265678	Weißer Diffusor für Aluminiumprofil, Komplett 10 Stk., SHADE J/K-W 2m(26567)   White shade for aluminium profile, package 10 pcs., SHADE J/K-W 2m(26567)
HANDLE J/K	26595	5905339265951	Haltevorrichtung für Aluminiumprofil, HANDLE J/K (26595)   Aluminium profile mounting bracket, HANDLE J/K (26595)
STOPPER J	26588	5905339265883	Schutzkappe für Aluminiumprofil, STOPPER J (26588)   Aluminium profile caps, STOPPER J (26588)
STOPPER J-W	26605	5905339266057	Schutzkappe für Aluminiumprofil, STOPPER J-W (26605)   Aluminium profile caps, STOPPER J-W (26605)

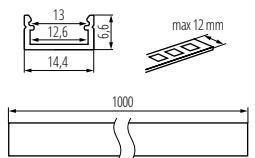

PROFILO J; J-W

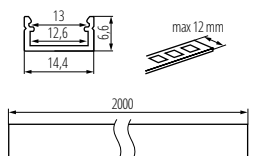

PROFILO J; J-W 2M

# PROFILO K

ALUMINIUMPROFIL ► ALUMINIUM PROFILE



PROFILO K



PROFILO K-W



Einbau-Deko-Profil für LED-Lichtstreifen.

Einbau-Deko-Profil für LED-Lichtstreifen

Set: 10 Stück

Material: Aluminiumlegierung

Recessed decorative lighting profile

Material: aluminum alloy



PROFILO K	<b>26548</b>	5905339265487	Eloxiert   anodised	1000
PROFILO K.2m	<b>26549</b>	5905339265494	Eloxiert   anodised	2000
PROFILO K-W	<b>26550</b>	5905339265500	weiß   white	1000
PROFILO K-W.2m	<b>26551</b>	5905339265517	weiß   white	2000

## ZUBEHÖR ► ACCESSORIES

SHADE J/K-FR	<b>26564</b>	5905339265647	Mattierter Diffusor für Aluminiumprofil, Komplett 10 Stk., SHADE J/K-FR(26564)   Frosted light cover for aluminium profile, package 10 pcs., SHADE J/K-FR(26564)
SHADE J/K-FR.2m	<b>26566</b>	5905339265661	Mattierter Diffusor für Aluminiumprofil, Komplett 10 Stk., SHADE J/K-FR.2m(26566)   Frosted light cover for aluminium profile, package 10 pcs., SHADE J/K-FR.2m(26566)
SHADE J/K-W	<b>26565</b>	5905339265654	Weißer Diffusor für Aluminiumprofil, Komplett 10 Stk., SHADE J/K-W(26565)   White shade for aluminium profile, package 10 pcs., SHADE J/K-W(26565)
SHADE J/K-W.2m	<b>26567</b>	5905339265678	Weißer Diffusor für Aluminiumprofil, Komplett 10 Stk., SHADE J/K-W.2m(26567)   White shade for aluminium profile, package 10 pcs., SHADE J/K-W.2m(26567)
HANDLE J/K	<b>26595</b>	5905339265951	Haltevorrichtung für Aluminiumprofil, HANDLE J/K (26595)   Aluminium profile mounting bracket, HANDLE J/K (26595)
STOPPER K	<b>26589</b>	5905339265890	Schutzkappe für Aluminiumprofil, STOPPER K (26589)   Aluminium profile caps, STOPPER K (26589)
STOPPER K-W	<b>26606</b>	5905339266064	Schutzkappe für Aluminiumprofil, STOPPER K-W (26606)   Aluminium profile caps, STOPPER K-W (26606)

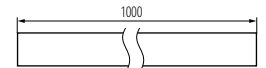
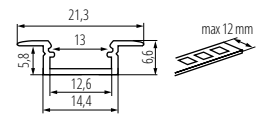

PROFILO K; K-W

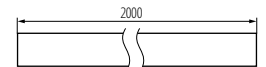
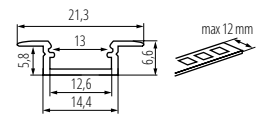

PROFILO K; K-W.2M



# NEON LED12W/M

NEON LED ► NEON LED



NEON LED12W/M IP65



NEON END CAP

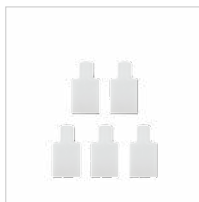

NEON END CAP HOLE

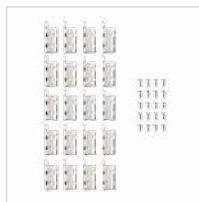

NEON MOUNTING CLIP

NEON LED12W/M IP65-VWV	<b>37234</b>	5905339372345	0,5m = 6	0,5m=110	2700	6	warmweiß   warm white	80	5000		
NEON LED12W/M IP65-NW	<b>37235</b>	5905339372352	0,5m = 6	0,5m=160	4000	6	weiß   white	80	5000		
NEON LED12W/M IP65-CW	<b>37236</b>	5905339372369	0,5m = 6	0,5m=120	5700	6	kaltweiß   cold white	80	5000		
NEON LED12W/M IP65-BL	<b>37237</b>	5905339372376	0,5m = 6	0,5m=20	-	-	blau   blue	-	5000		

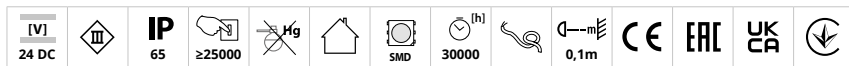

ZUBEHÖR ► ACCESSORIES

NEON END CAP	<b>37239</b>	5905339372390	NEON LED-Endkappe, NEON END CAP (37239)   NEON LED cap, NEON END CAP (37239).
NEON END CAP HOLE	<b>37238</b>	5905339372383	NEON LED-Endkappe mit Loch, NEON END CAP HOLE (37238)   NEON LED cap, NEON END CAP HOLE (37238).
NEON MOUNTING CLIP	<b>37229</b>	5905339372291	Halterung für NEON LED, NEON MOUNTING CLIP (37229)   Mounting bracket for NEON LED , NEON MOUNTING CLIP (37229).



Kanlux NEON LED sind einzigartige LED-Streifen die in drei Farbtemperaturen erhältlich sind: Kaltweiß, Warmweiß, Neutralweiß und Blau. Sie sind wasserdicht (IP65) und außergewöhnlich flexibel. Ihr Vorteil ist die gleichmäßige Ausleuchtung über die gesamte Länge (keine Lichtpunkte sichtbar) und eine 3-jährige Garantie. Kanlux NEON LED ist ein sehr helles Band, das nicht nur für den privaten, sondern auch für den kommerziellen Gebrauch geeignet ist. Ihre Flexibilität und Elastizität ermöglichen sie in nahezu unbegrenzte Formen zu formen. Jeder Kanlux NEON LED-Streifen ist 5 Meter lang und wird mit 24V betrieben..

3 Jahre Garantie gemäß den Bedingungen der Garantieerklärung, die auf der Website verfügbar ist  
 Es ist nicht erlaubt, LED Streifen in Abschnitten von mehr als 5 m zu verbinden.  
 Anwendungen, die den Einsatz von längeren Abschnitten erfordern, sollen elektrisch in Teilen mit einer Länge von max. 5 m geteilt (parallel verbunden) werden.

Kanlux NEON LED are unique LED strips available in three color temperatures: cold white, warm white, neutral white and blue. They are waterproof (IP65) and exceptionally flexible. Their advantage is uniform illumination along the entire length (no light points visible) and a 3-year warranty. Kanlux NEON LED is a very bright light that can be successfully used not only for home or commercial use, but also as advertising NEONS. Their flexibility and elasticity allow them to be formed into virtually unlimited shapes. Each Kanlux NEON LED strip is 5 meters long and is powered by 24V.

3 years Warranty under the terms of the warranty statement, available on our website  
 Linking LED strips into a section exceeding 5 m is not permitted. Applications requiring longer sections should be electrically divided (connected in parallel) into sections not exceeding 5 m in length.

Kanlux NEON LED is equipped with a socket that can be connected to the plug with a cable included in the package for easy installation.

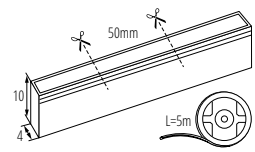

NEON LED12W-M IP65

**Kanlux**

# NEON LED12W/M

NEON LED ► NEON LED



NEON LED12W/M IP65-WW

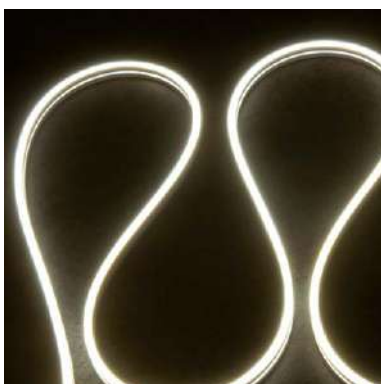

NEON LED12W/M IP65-NW

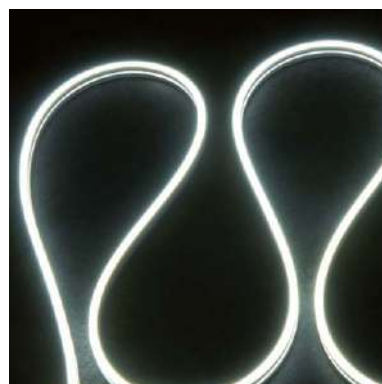

NEON LED12W/M IP65-CW

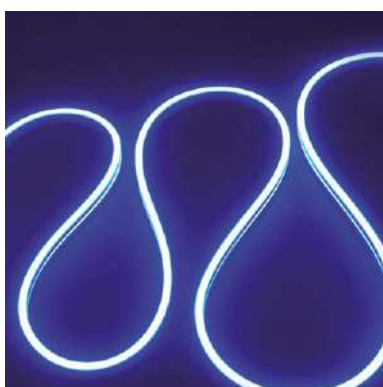

NEON LED12W/M IP65-BL



# Kanlux XLED HP D9

LED-LEUCHTMITTEL ► LED LIGHT SOURCE

NEW



XLED HP D90E27 26W



Kanlux XLED HP D90E27 ist das LED-Äquivalent zu speziellen Halogenlampen mit E27-Sockel. Diese professionelle Lichtquelle hat eine Lichtausbeute von über 150 lm/W, was sie effizienter macht als ihre Halogenvorgänger und hilft, Stromkosten zu sparen. Darüber hinaus hat sie eine Lebensdauer von 25.000 Stunden.

3 Jahre Garantie gemäß den Bedingungen der Garantieerklärung, die auf der Website verfügbar ist

Abdeckungsmaterial: Glas

Kanlux XLED HP D90E27 is the LED equivalent of specialised halogen bulbs with an E27 cap. This professional light source has a luminous efficacy of over 150lm/w making it more efficient than its halogen antecedent and helping to save on electricity expenses. In addition, it has a service life of 25,000 hours.

3 years Warranty under the terms of the warranty statement, available on our website  
The product fulfills IP65 requirements except lamp cap, outdoor applications require the lamp to be used in luminaires with suitable IP rating. Lamp cap needs to be installed in correct IP rated socket.

Lampshade material: glass

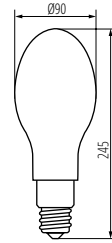

XLED HP D90E27 26W

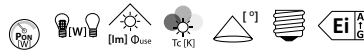

XLED HP D90E27 26W-NW | 37346 | 5905339373465 | 26 | 227 | 4000 | 4000 | 320 | E27 | D

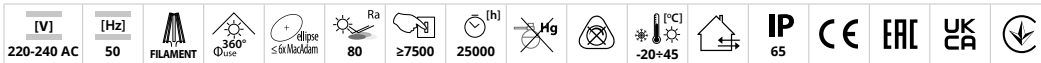

# Kanlux XLED HP D46

LED-LEUCHTMITTEL ► LED LIGHT SOURCE

NEW



XLED HP D46E40 38W

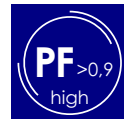

Kanlux XLED HP D46E40 ist das LED-Äquivalent von speziellen Halogenlampen mit E40-Sockel. Diese professionelle Lichtquelle hat eine Lichtausbeute von fast 200 lm/W, was sie mehr als 10 Mal effizienter macht als ihre Halogenvorgänger. Darüber hinaus hat sie eine Lebensdauer von 25.000 Stunden.

3 Jahre Garantie gemäß den Bedingungen der Garantieerklärung, die auf der Website verfügbar ist

Abdeckungsmaterial: Glas

Kanlux XLED HP D90E27 is the LED equivalent of specialised halogen bulbs with an E27 cap. This professional light source has a luminous efficacy of over 150lm/w making it more efficient than its halogen antecedent and helping to save on electricity expenses. In addition, it has a service life of 25,000 hours.

3 years Warranty under the terms of the warranty statement, available on our website  
The product fulfills IP65 requirements except lamp cap, outdoor applications require the lamp to be used in luminaires with suitable IP rating. Lamp cap needs to be installed in correct IP rated socket.

Lampshade material: glass

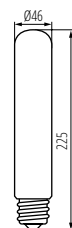

XLED HP D90E27 26W

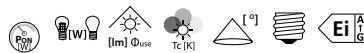

XLED HP D46E40 38W-NW | 37347 | 5905339373472 | 38 | 402 | 7500 | 4000 | 320 | E40 | B

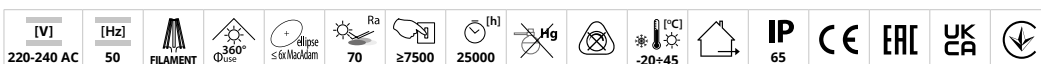

# Kanlux G9 STAR

HALOGENLEUCHTMITTEL ► HALIDE LIGHT SOURCE



G9-20W; 33W; 48W; 60W STAR

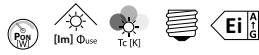

	[W]	[lm]	[h]	[Ra]	[h]	[Tc [K]]	[Base]	[E]
G9-20W STAR	18420	5905339184207	20	235	2700	G9	G	
G9-33W STAR	18421	5905339184214	33	460	2700	G9	G	
G9-48W STAR	18422	5905339184221	48	740	2700	G9	G	
G9-60W STAR	18423	5905339184238	60	975	2700	G9	G	

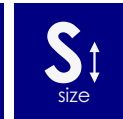
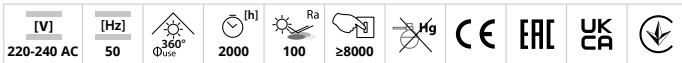

Kanlux G9 STAR ist ein Halogenleuchtmittel mit G9-Fassung. NICHT VERFÜGBAR FÜR DEN DEUTSCHEN MARKT!!!!

Material: Nicht korrodierende Metalllegierung  
Abdeckungsmaterial: Glas

Kanlux G9 STAR is a halogen bulb with G9 light bulb base.

Material: non-corrosive metals alloy  
Lampshade material: glass

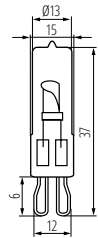

G9-20W; 33W; 48W; 60W STAR

# Kanlux J

HALOGENLEUCHTMITTEL ► HALIDE LIGHT SOURCE



J-1000W 189MM

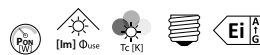

	[W]	[lm]	[h]	[Ra]	[h]	[Tc [K]]	[Base]	[E]
J-1000W 189MM	10418	5905339104182	1000	16000	2700	R7s	G	



Die entworfenen Halogenleuchtmittel sind für Leuchten und Halopaks mit R7s-Gewinde bestimmt. Verfügbare Leistung von 1000W bis 1500W.

Für den Einsatz in horizontaler Lage, zulässige Neigung der Arbeitsposition +/-4°  
Abdeckungsmaterial: Glas

The designed halogen bulbs are intended for lamps and halopaks with R7s thread. Available power from 1000W to 1500W. They are meant for horizontal work.

designed for horizontal operation, allowable deflection of working position +/-4°  
Lampshade material: glass

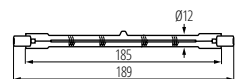

J-1000W 189MM

# Kanlux J STAR

HALOGENLEUCHTMITTEL ► HALIDE LIGHT SOURCE



J-80W 78MM STAR

			P <sub>nom</sub> [W]	[lm] Φ <sub>use</sub>	T <sub>c</sub> [K]		Ei
J-80W 78MM STAR	<b>08490</b>	5905339084903	80	1380	2700	R7s	G
J-120W 78MM STAR	<b>08491</b>	5905339084910	120	2230	2700	R7s	G
J-120W 118MM STAR	<b>08500</b>	5905339085009	120	2230	2700	R7s	G

[V]	[Hz]	360° Φ <sub>use</sub>	[h]	Ra	≥8000	Hg	CE	EAC	UK CA	↓
220-240 AC	50		2000	100						

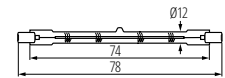

J-120W; 120W 78MM STAR

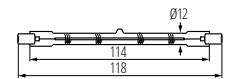

J-120W; 160W; 230W; 400W 118MM STAR



Die entworfenen Halogenleuchtmittel sind für Leuchten und Halopaks mit R7s-Gewinde bestimmt. Verfügbare Leistung von 80W bis 400W.

Durchschnittlich um 23% größerer Lichtstrom, bei einem um 20% niedrigeren Stromverbrauch (im Vergleich mit einer Halogenleuchte der Klasse F)

Für den Einsatz in horizontaler Lage, zulässige Neigung der Arbeitsposition +/-4°

Abdeckungsmaterial: Glas

The designed halogen bulbs are intended for lamps and halopaks with R7s thread. Available power from 80W to 400W. They are meant for horizontal work.

23% more light flux by 20% lower power consumption (compared to F class halogen) designed for horizontal operation, allowable deflection of working position +/-4°

Lampshade material: glass

# Kanlux T5

LEUCHTSTOFFFRÖHRE ► LINEAR FLUORESCENT LAMP



T5-8W 4000K/65

			P <sub>nom</sub> [W]	[lm] Φ <sub>use</sub>	T <sub>c</sub> [K]		Ra	[h]	Ei
T5-8W 4000K/65	<b>12715</b>	5905339127150	8	688	4000	G5	65	10000	G
T5-13W 4000K/65	<b>12716</b>	5905339127167	13	1118	4000	G5	65	10000	G
T5-14W 4000K/82	<b>12717</b>	5905339127174	14	1204	4000	G5	82	20000	G

Hg	360° Φ <sub>use</sub>	CE	EAC	UK CA	↓
----	--------------------------	----	-----	-------	---



Kanlux T5 sind Langfeld-Leuchtstofflampen. Niedriger Stromverbrauch und eine lange Arbeitszeit sind zweifellos die Vorteile dieser Lampen.

T5-8W, T5-13W: Einbandleuchtstofflampen, die übrigen Modelle sind Dreibandleuchtstofflampen

Material: Glas

Kanlux T5 are oneband and tri-band linear fluorescent lamps. Low consumption of energy and long working time are indisputable advantages of these lamps.

T5-8W, T5-13W: fluorescent lamps, other models are tri-band fluorescent

Material: glass

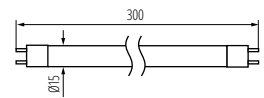

T5-8W 4000K/65



T5-13W 4000K/65

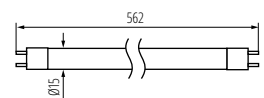

T5-14W 4000K/82

**Kanlux**

# T8

LEUCHTSTOFFRÖHRE ► LINEAR FLUORESCENT LAMP



T8 36W



T8 18W/840 NW	<b>19921</b>	5905339199218	18	1350	4000	G13	G
T8 18W/865 CW	<b>19922</b>	5905339199225	18	1250	6500	G13	G
T8 36W/840 NW	<b>19924</b>	5905339199249	36	3350	4000	G13	F
T8 36W/865 CW	<b>19925</b>	5905339199256	36	3050	6500	G13	G

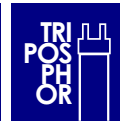
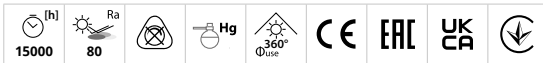

Kanlux T8 sind Langfeld-Leuchtstofflampen. Niedriger Stromverbrauch und eine lange Arbeitszeit (15.000 h) sind zweifellos die Vorteile dieser Lampen.

NUR IN VERPACKUNGSEINHEIT - 25 STÜCK ERHÄLTLICH

Material: Glas

Kanlux T8 are triband linear fluorescent lamps. Low consumption of energy and long working time (15.000H) are indisputable advantages of these lamps.

Material: glass

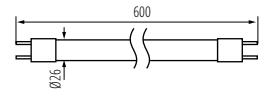

T8 18W

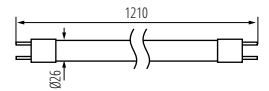

T8 36W

**Kanlux**

# MHE

HALOGENMETALLDAMPFLAMPE ► METAL-HALIDE LAMP



MHE-250W/4200K



MHE-250W/4200K	<b>12755</b>	5905339127556	250	23000	4200	E40	12000	F
MHE-400W/4200K	<b>12756</b>	5905339127563	400	38000	4200	E40	10000	F



Kanlux MHE-Metallhalogelampen funktionieren mit Vorschaltgeräten für Natriumdampf-Hochdrucklampen / Metallhalogelampen und Startern für Metallhalogelampen.

Material: Glas

Kanlux MHE metal-halide lamps work with stabilizers for high-pressure sodium lamps/metal-halide lamps and igniters for metal-halide lamps.

Material: glass

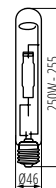

MHE-250W

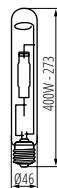

MHE-400W

# ***Kanlux***





**WOHNRAUMLEUCHTEN UND DEKORATIVE LEUCHTEN**  
DOMESTIC AND DECORATIVE FIXTURES

**Jeden Tag sind wir in Ihrem Zuhause zu Gast.  
Sie sorgen dafür, dass Ihre Innenräume schön sind,  
und wir kümmern uns darum, dass unsere Produkte  
bis ins kleinste Detail ausgearbeitet sind.**

We are present in your house every day.  
You take care of the beauty of your interiors,  
and we take care of refining our products  
down to in the finest detail.



*Photometrische Daten finden Sie unter:  
photometric data you can find on:*

► [kanlux.com](https://www.kanlux.com)



# Kanlux AGZAR C

PENDELLEUCHE ✦ PENDANT LAMP



AGZAR C 3xE14 B

AGZAR C 3xE14 W

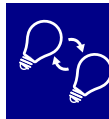

Kanlux AGZAR ist eine stählerne und elegante Leuchte mit einem interessanten und modernen Design. Ein unbestreitbarer Vorteil dieser Leuchten ist die Möglichkeit, den Lampenschirm weit zu drehen. Die Drähte sind in ein Stoffgeflecht eingebettet und die Lampe ist mit viel Liebe zum Detail gefertigt. Kanlux AGZAR Pendelleuchten haben 3 Lichtpunkte (Leuchtmittel mit E14-Sockel und einer maximalen Leistung von 5W) und sind PREMIUM-Leuchten.

Gehäusematerial: Stahl

Kanlux AGZAR is a steel and elegant version of luminaires with an interesting and modern design. An undoubted advantage of these fittings is the ability to rotate the lampshade. The cables are braided and the lamp is made with attention to every detail. Kanlux AGZAR suspended luminaires have 3 light points (light sources with an E14 cap and a maximum power of 5W) and they are PREMIUM class luminaires.

Enclosure material: steel



AGZAR C 3xE14 B	<b>36252</b>	5905339362520	3 x max 5W	schwarz   black
AGZAR C 3xE14 W	<b>36253</b>	5905339362537	3 x max 5W	weiß   white

[V]	[Hz]	[Socket]	[Ground]	IP	[House]	[Temp]	[Mount]	[Rotation]
220-240 AC	50	E14		20		5+25		310
[Rotation]	[Cable]	[Length]	[Weight]	[CE]	[EAC]	[UKCA]	[Energy]	
180	3 x 1+2,5	0,5m						

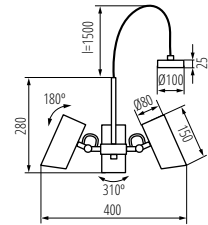

AGZAR C 3xE14

# Kanlux GALOBA C

PENDELLEUCHE ✦ PENDANT LAMP



GALOBA C 1XGU10 B

GALOBA C 3XGU10 B



GALOBA C 1XGU10 W



GALOBA C 3XGU10 W

Kanlux GALOBA ist eine komplette Beleuchtungsserie mit Pendelleuchten (GALOBA C), Wandleuchten (GALOBA W) sowie Wand- und Deckenleuchten. Kanlux GALOBA C Hängelampen können erfolgreich als Insel- oder Tischbeleuchtung eingesetzt werden, Wand- und Deckenleuchten (von 1-er bis 4-er Leuchten) können in einem Wohnzimmer, einem Flur oder einem Schlafzimmer verwendet werden. Die Einrichtung wird durch Wandlampen mit einem Schalter im Sockel vervollständigt. Die gesamte Leuchtenserie Kanlux GALOBA hat einen abschraubbaren Lampenschirm, dank dem die Leuchtmittel schnell und bequem ausgetauscht werden können. Die maximale Höhe des Leuchtmittels beträgt bei GALOBA Leuchten 55 mm. Wir empfehlen die Lampen Kanlux SMART (S GU10) oder iQ-LED LIFE (iQ LED L GU10).

Maximale Höhe der Leuchtmittel 55mm

Gehäusematerial: Aluminiumlegierung

Kanlux GALOBA is a complete series of luminaires, including pendant lamps (GALOBA C), wall lamps (GALOBA W) and wall and ceiling fixtures. Kanlux GALOBA C pendant lamps can be successfully used for the lighting of islands or tables, while wall and ceiling lamps (from 1 to 4 points of light) can be used in a living room, hall or bedroom. The arrangement can be completed with wall lamps, which have a switch in the base. All luminaires from the Kanlux GALOBA series have a detachable lampshade thanks to which the light sources can be quickly and comfortably replaced.

Maximum light-source height 55mm

Enclosure material: aluminum alloy

GALOBA C 1xGU10 W	<b>33682</b>	5905339336828	max 35	weiß   white
GALOBA C 1xGU10 B	<b>33683</b>	5905339336835	max 35	schwarz   black
GALOBA C 3xGU10 W	<b>33684</b>	5905339336842	3 x max 35	weiß   white
GALOBA C 3xGU10 B	<b>33685</b>	5905339336859	3 x max 35	schwarz   black



[V]	[Hz]	[Socket]	[Ground]	IP	[House]	[Temp]	[Mount]
220-240 AC	50	PAR16		20		5+25	
[Cable]	[Length]	[Weight]	[CE]	[EAC]	[UKCA]	[Energy]	
0,75+1,5	0,5m						

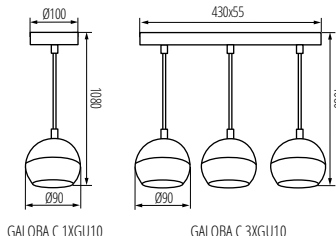

GALOBA C 1XGU10

GALOBA C 3XGU10

# Kanlux JASMIN C

PENDELLEUCHTE ▶ PENDANT LAMP

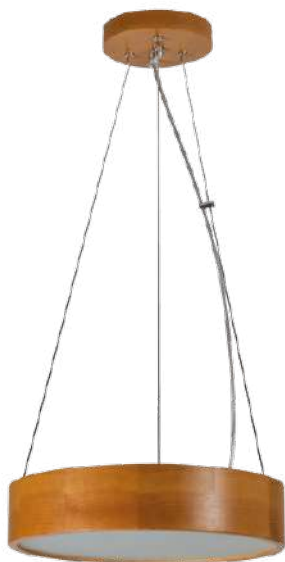

JASMIN C 470-G/O



JASMIN C 270-G/O



JASMIN C 370-G/O



Kanlux JASMIN ist eine Familie von runden Hängeleuchten aus Holz mit austauschbarer Lichtquelle. Erhältlich sind verschiedene Größen und Farben des Deckenleuchters - zu jeder passen 1 bis 3 Lichtquellen mit E27-Sockel. Die Leuchten können mit Wandlampen und Deckenleuchter der gleichen Serie ergänzt werden.

Stahlseil - Leuchte  
Gehäusematerial: Holz  
Abdeckungsmaterial: Glas

Kanlux JASMIN is a family of wooden, round hanging holders with a replaceable source of light. Different sizes and colours of ceiling light fixtures are available - from 1 to 3 light sources with E27 light bulb base match each of them. The holders can be enriched by wall lamps and ceiling light fixtures of the same series.

fitting suspended on steel rings  
Enclosure material: Wood  
Lampshade material: glass



JASMIN C 270-G/O	<b>36499</b>	5905339364999	max 20	E27	gold eiche   golden oak
JASMIN C 370-G/O	<b>36500</b>	5905339365002	2 x max 20	E27	gold eiche   golden oak
JASMIN C 470-G/O	<b>36501</b>	5905339365019	3 x max 20	E27	gold eiche   golden oak
JASMIN C 270-W/M	<b>36502</b>	5905339365026	max 20	E27	weiß matt   matte white
JASMIN C 370-W/M	<b>36503</b>	5905339365033	2 x max 20	E27	weiß matt   matte white
JASMIN C 470-W/M	<b>36504</b>	5905339365040	3 x max 20	E27	weiß matt   matte white
JASMIN C 270-B	<b>36505</b>	5905339365057	max 20	E27	schwarz   black
JASMIN C 370-B	<b>36506</b>	5905339365064	2 x max 20	E27	schwarz   black
JASMIN C 470-B	<b>36507</b>	5905339365071	3 x max 20	E27	schwarz   black

[V] 220-240 AC	[Hz] 50	⏚	IP 20	🏠	🌡️ 5-25	⬆️
🔌 0,5m	🔧 1	🐜	CE	EAC	UK CA	🔄

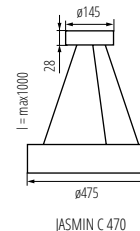
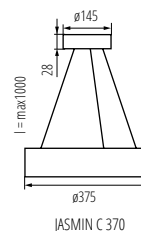
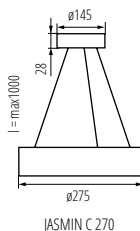

# Kanlux ETISSA

PENDELLEUCHE ▶ PENDANT LAMP



ETISSA D20 GR



ETISSA D20 GR | 27000 | 5905339270009 | max 40 | grau | grey

[V] 220-240 AC	[Hz] 50	E27	IP 20	⌚ 5+25	⚡
Ⓜ 0,75+2,5	Ⓜ 0,5m	⚡	CE	ERAC	UKA



Kanlux ETISSA sind Pendelleuchten, die mit allen Leuchtmitteln mit E27-Sockel kompatibel sind. Die Leuchten sind aus Betonmasse gefertigt. Stilistisch gesehen handelt es sich um Produkte in einem rohen Loftflair, die ideal zu modernen, minimalistischen Innenräumen passen. Ihre Beschichtung ist porös, was für Betonoberflächen typisch ist.

Abdeckungsmaterial: Gipsabguss

Kanlux ETISSA are hanging lamps which cooperate with all sources of light with E27 light bulb base. Holders are made of concrete mass. In stylistic terms, they are products in a severe, loft-like climate, perfectly matching modern, minimalist interiors. Their coating is porous, which is characteristic of concrete surfaces.

Lampshade material: plaster cast

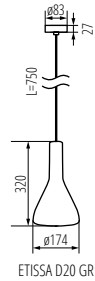

ETISSA D20 GR

# Kanlux OGIVA

PENDELLEUCHE ▶ PENDANT LAMP



OGIVA D35 GR



OGIVA D35 GR | 27001 | 5905339270016 | max 40 | grau | grey

[V] 220-240 AC	[Hz] 50	E27	IP 20	⌚ 5+25	⚡
Ⓜ 0,75+2,5	Ⓜ 0,5m	⚡	CE	ERAC	UKA

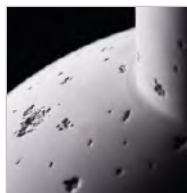

Kanlux OGIVA sind Pendelleuchten, die mit allen Leuchtmitteln mit E27-Sockel kompatibel sind. Die Leuchten sind aus Betonmasse in Naturfarbe (grau) ausgeführt. Stilistisch gesehen handelt es sich um Produkte in einem rohen Loftstil, die ideal zu modernen, minimalistischen Innenräumen passen. Ihre Beschichtung ist porös, was für Betonoberflächen typisch ist. Die Leuchten werden in Polen hergestellt.

Abdeckungsmaterial: Gipsabguss

Kanlux OGIVA are hanging lamps co-operating with all light sources with E27 light bulb base. Luminaires are made of concrete mass of natural colour (grey). In terms of style, the products have austere, loft style, perfectly matching modern, minimalist interiors. Their coating is porous, which is characteristic of concrete surfaces. The lamps are manufactured in Poland.

Lampshade material: plaster cast

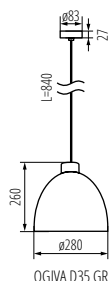

OGIVA D35 GR

Kanlux

# SONOR GU10

AUFBAU DOWNLIGHT DECKENLEUCHE ▶ CEILING-MOUNTED SPOTLIGHT FITTING



SONOR GU10 CO-B



SONOR GU10 CO-B-WW | **24362** | 5905339243621 | max 10 | schwarz | black

[V]	[Hz]	[W]/LED	PAR16	GU10	(lm)	≥15000	(h)	TC (K)
220-240 AC	50	4			100		20000	3000
Glipse ≤ 6x Maxdäm	Ra	SMD			IP		5+25	
	80				20			
	[mm]			CE	UK			
	1,5-2,5	0,5m						

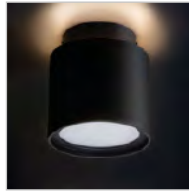
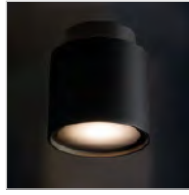
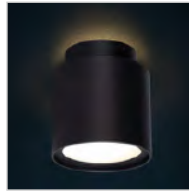

Kanlux SONOR GU10 ist eine Aufbauleuchte mit einem zusätzlichen LED-Streifen. Dank zweier unabhängiger Leuchtmittel kann diese Lampe auf drei verschiedene Arten leuchten. Erste Variante: Leuchtet nur der LED-Streifen, entsteht ein Deckeneffekt, ideal als Abendlicht; Zweite Variante: Leuchtet nur das Leuchtmittel in der Leuchte, erzeugt die Leuchte dank des Kunststoffdiffusors eine besondere Lichtatmosphäre; Die dritte Variante besteht darin, dass beide Leuchtmittel gleichzeitig leuchten und somit die Möglichkeiten der Leuchte voll ausschöpfen. Für den besten Effekt wird empfohlen, Leuchtmittel mit einer Farbtemperatur von 3000 K zu verwenden. Für den Betrieb der Lampen Kanlux SONOR empfehlen wir die Verwendung eines Zwei-Gruppen-Schalters (Doppelschalter), um die Möglichkeiten der Beleuchtung dieser Lampen zu zeigen.

Gehäusematerial: Aluminiumlegierung  
Abdeckungsmaterial: Kunststoff

Kanlux SONOR GU10 is a surface-mounted luminaire with an additional LED strip. Thanks to two independent light sources, this lamp can shine in three different ways. With only the LED strip shining (ceiling effect, ideal as evening light), only the bulb in the luminaire shining (thanks to the plastic lampshade, the luminaire looks like an integrated one), while the third variant is to light both light sources simultaneously and make full use of its possibilities. For best effect, we recommend the use of light bulbs with a colour temperature of 3000 K. For Kanlux SONOR lamps, we recommend the use of a two-group (double) switch in order to take full advantage of the possibilities of lighting these lamps.

Enclosure material: aluminum alloy  
Lampshade material: plastic

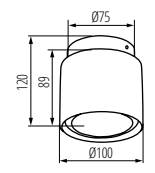

SONOR GU10 CO

Kanlux

# SANI IP44

AUFBAU DOWNLIGHT DECKENLEUCHE ▶ CEILING-MOUNTED SPOTLIGHT FITTING



SANI IP44 DSO-B



SANI IP44 DSO-W



SANI IP44 DSO-SN



SANI IP44 DSO-B	<b>29240</b>	5905339292407	max 10	schwarz   black
SANI IP44 DSO-W	<b>29241</b>	5905339292414	max 10	weiß   white
SANI IP44 DSO-SN	<b>29242</b>	5905339292421	max 10	satiniertes Nickel   nickel satin

[V]	[Hz]	PAR16	GU10	IP		5+25
220-240 AC	50			44		
	[mm]					
	0,75+1,5	0,5m		CE	UK	



KANLUX SANI IP44 sind Aufputzleuchten. Sie zeichnen sich durch einen schlichten Stil aus und sind in drei Farben erhältlich - weiß, schwarz und Nickel satiniert. Die hohe Dichtigkeit der Leuchten (IP44) ermöglicht den Einsatz in Räumen, in denen elektrische Geräte einer erhöhten Luftfeuchtigkeit IP44 ist nicht unter wasser kompatibel ausgesetzt sind, u. a. in Bad und Küche.

Leuchte nur für den Betrieb mit einem LED-Leuchtmittel geeignet.  
Gehäusematerial: Aluminiumlegierung  
Abdeckungsmaterial: Kunststoff

KANLUX SANI IP44 are surface holders. They are characterized by simple stylistics and availability in two colours - white and black. High tightness of the holders (IP44) allows using them in rooms where electric devices are exposed to increased humidity and risk of flooding with water e.g. bathroom and kitchen.

Luminaire only for LED source.  
Enclosure material: aluminum alloy  
Lampshade material: plastic

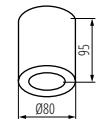

SANI IP44 DSO

# AQILO IP65

AUFBAU DOWNLIGHT DECKENLEUCHE ▶ CEILING-MOUNTED SPOTLIGHT FITTING



AQILO IP65 DSO-W



KANLUX AQILO ist unsere erste Anbauleuchte mit einem so hohen Schutzgrad - IP65. Sie zeichnet sich durch eine einfache Stilistik aus und ist in drei Farben erhältlich: Weiß, Schwarz und Graphit. Dank der hohen Dichtheit ist KANLUX AQILO für Räume vorgesehen, in denen Leuchten Wasser und erhöhter Luftfeuchtigkeit ausgesetzt sind, z. B. in Bad und Küche sowie für den Einsatz im Außenbereich des Hauses wie Terrassen, Balkone oder überdachte Eingänge.

Gehäusematerial: Aluminiumlegierung  
Abdeckungsmaterial: Kunststoff



KANLUX AQILO is the first Kanlux surface-mounted luminaire with such a high IP degree - IP65. It is characterized by a simple design and availability in three colors: white, black and graphite. High tightness is intended for rooms where the lamps are exposed to increased humidity and the risk of flooding with water, e.g. bathroom and kitchen, and for use in external areas of the house, such as terraces, balconies or covered entrances. You can choose the light sources that suit you. An additional advantage of AQILO E14 and AQILO E27 lamps is the reflector.

Enclosure material: aluminum alloy  
Lampshade material: plastic



AQILO IP65 DSO-W	<b>33360</b>	5905339333605	max 7	weiß   white
AQILO IP65 DSO-B	<b>33361</b>	5905339333612	max 7	schwarz   black
AQILO IP65 DSO-GR	<b>33362</b>	5905339333629	max 7	graphit   graphite
AQILO E14 IP65 DSO-GR	<b>36640</b>	5905339366405	max 10	graphit   graphite
AQILO E14 IP65 DSO-W	<b>36641</b>	5905339366412	max 10	weiß   white
AQILO E14 IP65 DSO-B	<b>36642</b>	5905339366429	max 10	schwarz   black
AQILO E27 IP65 DSO-GR	<b>36643</b>	5905339366436	max 20	graphit   graphite
AQILO E27 IP65 DSO-W	<b>36644</b>	5905339366443	max 20	weiß   white
AQILO E27 IP65 DSO-B	<b>36645</b>	5905339366450	max 20	schwarz   black

[V] 220-240 AC	[Hz] 50	⏏	IP 65	🏠	🌡️ -20+35	⚡
📦	📏 0,5m	🔧	CE	EAC	UK CA	⬇️

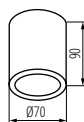

AQILO IP65 DSO

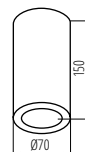

AQILO E14 IP65 DSO

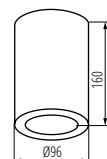

AQILO E27 IP65 DSO

**Kanlux**

# AQILO IP65

AUFBAU DOWNLIGHT DECKENLEUCHTE ▶ CEILING-MOUNTED SPOTLIGHT FITTING

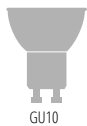

AQILO IP65 DSO-GR



AQILO IP65 DSO-W



AQILO IP65 DSO-B



AQILO E14 IP65 DSO-GR



AQILO E14 IP65 DSO-W



AQILO E14 IP65 DSO-B



AQILO E27 IP65 DSO-GR



AQILO E27 IP65 DSO-W



AQILO E27 IP65 DSO-B



# Kanlux STOBI

AUFBAU DOWNLIGHT DECKENLEUCHE ▶ CEILING-MOUNTED SPOTLIGHT FITTING



STOBI DLP 50-B



Kanlux STOBI ist eine Deckenleuchtenserie für austauschbare Leuchtmittel. Sie sind aus Aluminium gefertigt und ermöglichen es den Lichteinfallswinkel individuell einzustellen. Hochwertige Verarbeitung (matte, sandgestrahlte Oberfläche) und schlichtes Design machen die Leuchten perfekt, sowohl für Wohnräume als auch für Büros.

Gehäusematerial: Aluminiumlegierung

The Kanlux STOBI is the line of ceiling fixtures, with a replaceable light source. They are in aluminium with a fully adjustable light-beam angle. The high-quality finish (matte, sanded surface), and simple style, make the fixtures perfect for rooms at home, and also for offices and apartments.

Enclosure material: aluminum alloy



STOBI DLP 50-W



STOBI DLP 250-W

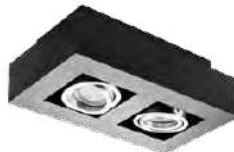

STOBI DLP 250-B



STOBI DLP 50-B	<b>26830</b>	5905339268303	max 10	schwarz   black
STOBI DLP 50-W	<b>26831</b>	5905339268310	max 10	weiß   white
STOBI DLP 250-B	<b>26832</b>	5905339268327	2 x max 10	schwarz   black
STOBI DLP 250-W	<b>26833</b>	5905339268334	2 x max 10	weiß   white

<b>[V]</b> 220-240 AC	<b>[Hz]</b> 50	 PAR16	 GU10	 IP 20	 5+25	 5+25	 1+2,5	 0,5m				
--------------------------	-------------------	-----------	----------	-----------	----------	----------	-----------	----------	--	--	--	--

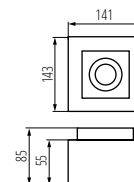

STOBI DLP 50

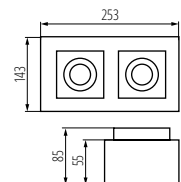

STOBI DLP 250

# Kanlux RITI

AUFBAU DOWNLIGHT DECKENLEUCHE ▶ CEILING-MOUNTED SPOTLIGHT FITTING



RITI GU10 W/W



RITI GU10 B/B



RITI GU10 W/G



RITI GU10 B/G



RITI GU10 B/B	<b>27567</b>	5905339275677	max 10	schwarz   black
RITI GU10 W/W	<b>27569</b>	5905339275691	max 10	weiß   white
RITI GU10 W/G	<b>27570</b>	5905339275707	max 10	weiß/ gold   white/ gold
RITI GU10 B/G	<b>27571</b>	5905339275714	max 10	schwarz/ gold   black/ gold

[V] 220-240 AC	[Hz] 50	PAR16	GU10	IP 20	5+25	⬆
0,75+1,5	0,5m	CE	ERC	UK CA	♻️	

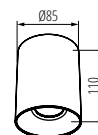

RITI GU10

# Kanlux BORD

AUFBAU DOWNLIGHT DECKENLEUCHE ▶ CEILING-MOUNTED SPOTLIGHT FITTING



BORD DLP-50-B



BORD DLP-50-W



BORD DLP-50-W	<b>22551</b>	5905339225511	max 10	weiß matt   matte white
BORD DLP-50-B	<b>22552</b>	5905339225528	max 10	schwarz matt   black matt

[V] 220-240 AC	[Hz] 50	PAR16	GU10	IP 20	5+25	⬆	🔍
25	0,75+1,5	0,5m	CE	ERC	UK CA	♻️	

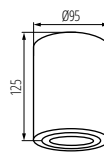

BORD DLP-50



Kanlux RITI besteht aus Aluminium, die sandgestrahlte Oberflächenstruktur ist matt lackiert und der Reflektor ist mit einer Schicht Gold-Kupfer-Lack mit einem glänzenden Pigment überzogen. Die RITI-Serie zeichnet sich durch gute Verarbeitungsqualität und modernes Design aus. Sie kann sowohl als eigenständiges Beleuchtungssystem oder als Kombination mehrerer Leuchten eingesetzt werden.

Gehäusematerial: Aluminiumlegierung

The Kanlux RITI is in aluminium, the sandblasted surface structure is matte-lacquered, and the reflector is covered with a layer of gold-copper lacquer with a shiny pigment. The Kanlux RITI series is characterised by good-quality workmanship and modern design. It can be successfully used as a stand-alone lighting system, or as a combination of several fixtures.

Enclosure material: aluminum alloy



Sanfte Kanten, geschwungene Linien und eine aerodynamische Form verleihen den Kanlux BORD-Leuchten Eleganz und Feinheit. Modernes Design, elegante Einfachheit und die aerodynamische Form machen diese Leuchten sowohl für Wohn- als auch für Geschäftsräume geeignet.

Gehäusematerial: Aluminiumlegierung

Kanlux BORD are popular surface holders. They are characterized by an interesting and expressive shape in the form of a cylinder. Kanlux BORD guarantee exceptional lighting making it possible to emphasize some elements of decor in a room and create pleasant atmosphere. Modern design and elegant simplicity make these holders match both residential interiors and commercial interiors.

Enclosure material: aluminum alloy



# Kanlux BORD XS

AUFBAU DOWNLIGHT DECKENLEUCHE ► CEILING-MOUNTED SPOTLIGHT FITTING



BORD XS DLP-50-B



BORD XS DLP-50-W



BORD XS DLP-50-B	<b>25478</b>	5905339254788	max 10W	schwarz   black
BORD XS DLP-50-W	<b>25479</b>	5905339254795	max 10W	weiß   white

[V]	[Hz]	PAR16 LED	GU10	⊕	IP	°C	⚡
220-240 AC	50			20	5+25		
	25		1+2,5	0,5m	CE	EAC	UK CA

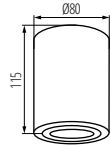

BORD XS DLP-50

# Kanlux GORD XS

AUFBAU DOWNLIGHT DECKENLEUCHE ► CEILING-MOUNTED SPOTLIGHT FITTING



GORD XS DLP-50-B



GORD XS DLP-50-W



GORD XS DLP-50-B	<b>25476</b>	5905339254764	max 10	schwarz   black
GORD XS DLP-50-W	<b>25477</b>	5905339254771	max 10	weiß   white

[V]	[Hz]	PAR16 LED	GU10	⊕	IP	°C	⚡
220-240 AC	50			20	5+25		
	25		1+2,5	0,5m	CE	EAC	UK CA

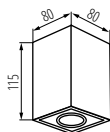

GORD XS DLP-50



Die weichen Kanten, die geschwungenen Linien und die stromlinienförmige Form verleihen den Kanlux BORD XS-Leuchten Eleganz und Raffinesse. Das moderne Design, die elegante Schlichtheit und die ovale Form machen diese Leuchten sowohl für Wohn- als auch für Geschäftsräume geeignet. Es handelt sich um eine neue Version der beliebten Kanlux BORD-Leuchten.

Gehäusematerial: Metall

Abdeckungsmaterial: Kunststoff

Gentle edges, curved lines and a streamlined shape give Kanlux BORD XS luminaires elegance and subtlety. Modern design, elegant simplicity and an oval shape make these luminaires fit both residential and commercial interiors. This is a new version of the popular Kanlux BORD luminaires.

Enclosure material: aluminum alloy



Kanlux GORD XS zeichnet sich durch ein neues, interessanteres Design als sein Vorgänger (Kanlux GORD) aus. Diese Leuchten garantieren eine außergewöhnliche Beleuchtung, die es ermöglicht, ausgewählte Elemente des Raumdekors zu betonen. Die veränderte Version dieser beliebten Leuchten wird Liebhabern geometrischer Formen gefallen.

Gehäusematerial: Aluminiumlegierung

Kanlux GORD XS has a new, more interesting style than its predecessor (Kanlux GORD). These luminaires provide unique lighting that allows you to emphasize selected elements of the interior design. The changed version of these popular luminaires will satisfy lovers of geometric shapes.

Enclosure material: aluminum alloy

# BLURRO

AUFBAU DOWNLIGHT DECKENLEUCHE ▶ CEILING-MOUNTED SPOTLIGHT FITTING



BLURRO GU10 CO-B



BLURRO GU10 CO-W



HIGH  
quality  
finish

DESIGN  
unique

Kanlux BLURRO ist eine Serie von Spotleuchten. Die moderne und minimalistische Form kann in vielen Räumen im Haus eingesetzt werden. Die freie Richtungseinstellung des Lichtstrahls ist ein weiterer Vorteil dieser Leuchte. Es kann zwischen Leuchten mit einem oder zwei Spots gewählt werden. Kanlux BLURRO passt ideal in das Wohnzimmer, die Küche, aber auch in den Flur.

Gehäusematerial: Aluminiumlegierung

Kanlux BLURRO are spot ceiling lamps. The unusual design of these luminaires can be successfully used in many rooms in the home. Free adjustment of the light beam direction is their additional advantage. We can choose a lamp with one or two points of light. Their shape is deceptively simple, but definitely boring. Kanlux BLURRO will successfully illuminate the living room, kitchen and hall. In larger rooms, we will successfully combine several luminaires.

Enclosure material: aluminum alloy



BLURRO 2xGU10 CO-B	<b>32952</b>	5905339329523	2 x max 10	schwarz   black
BLURRO 2xGU10 CO-W	<b>32953</b>	5905339329530	2 x max 10	weiß   white

[V] 220-240 AC	[Hz] 50	PAR16	GU10	IP 20	5+25	UK
60	0,75+1,5	0,5m	CE	ERL	UK	↓

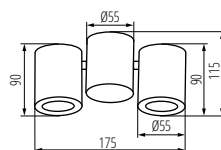

BLURRO 2xGU10 CO

Kanlux

# LUMKO LED

LED- DECKENLEUCHTE ▶ CEILING-MOUNTED LED LIGHT FITTING

NEW



LUMKO LED 17,5W NW



LUMKO LED 17,5W NW | 37320 | 5905339373205 | 17,5 | LED | 1480 | 4000 | weiß | white

[V] 220-240 AC	[Hz] 50	[°] 120	[lm] ≥20000	[h] 25000	ellipse ≤ für MacAdam	Ra 80	Hg X	SMD
[°C] IP 20	[°C] 5+25	[mm] 1,5	[m] 0,5m	[W] 85	CE	ERC	UK CA	[Symbol]



Kanlux LUMKO LED ist eine Leuchte, die für all diejenigen gedacht ist, die eine einfache Form der Leuchte suchen, aber nicht auf eine subtile Dekoration verzichten wollen. Kanlux LUMKO LED ist in der Farbe Elfenbein gehalten und der dekorative Ring im Sockel ist eine zusätzliche Dekoration.

Gehäusematerial: Metall

Abdeckungsmaterial: Kunststoff

Kanlux LUMKO LED is a ceiling lamp intended for everyone who is looking for a simple form of fixture, but does not want to give up subtle decorativeness. Kanlux LUMKO LED is ivory-colored, and its decorative ring in the base is an additional decoration.

Enclosure material: Metal

Lampshade material: plastic

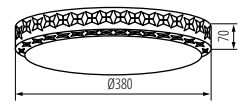

LUMKO LED 17,5W NW

Kanlux

# CARVO LED

LED- DECKENLEUCHTE ▶ CEILING-MOUNTED LED LIGHT FITTING

NEW



CARVO LED 17,5W NW



CARVO LED 17,5W NW | 37321 | 5905339373212 | 17,5 | LED | 1320 | 4000 | weiß | white

[V] 220-240 AC	[Hz] 50	[°] 120	[lm] ≥20000	[h] 25000	ellipse ≤ für MacAdam	Ra 80	Hg X	SMD
[°C] IP 20	[°C] 5+25	[mm] 1,5	[m] 0,5m	[W] 75	CE	ERC	UK CA	[Symbol]

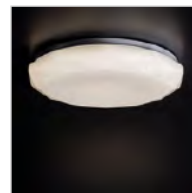

Kanlux CARVO LED ist eine Deckenleuchte, dessen Form an einen geschliffenen Diamanten erinnert. Elegante, geometrische Formen passen zu modernen Interieurs, und das subtile Licht der Deckenleuchte erhellt kleinere und mittlere Räume.

Gehäusematerial: Metall

Abdeckungsmaterial: Kunststoff

Kanlux CARVO LED is a ceiling lamp whose shape brings to mind a polished diamond. Elegant, geometric shapes will suit modern interiors, and the subtle light from the ceiling lamp will illuminate smaller and medium-sized rooms.

Enclosure material: Metal

Lampshade material: plastic

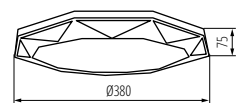

CARVO LED 17,5W NW

Kanlux

# BONSA LED

LED- DECKENLEUCHE ► CEILING-MOUNTED LED LIGHT FITTING

NEW



BONSA LED 17,5W NW



BONSA LED 17,5W NW | 37322 | 5905339373229 | 17,5 | LED | 1580 | 4000 | weiß | white

[V] 220-240 AC	[Hz] 50	[°] 120	[h] ≥20000	[h] 25000	ellipse ≤ 6x Nachdam	Ra 80	Hg	SMD
		IP 20	5+25			1,5	0,5m	
lm W 90	CE	EAC	UK CA					

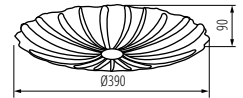

BONSA LED 17,5W NW



Die Deckenleuchte Kanlux BONSA LED ist eine Lampe, deren Form an eine Hochsteckfrisur aus Stoff erinnert. Sie wird bei Vintage-Liebhabern, aber auch bei Liebhabern des englischen Stils Anklang finden. Das Licht von Kanlux BONSA LED wird dank der Form und der Textur des Lampenschirms auf interessante Weise verteilt.

Gehäusematerial: Metall

Abdeckungsmaterial: Kunststoff

The Kanlux BONSA LED ceiling lamp is a lamp whose shape refers to a fabric updo. It will be appreciated by vintage lovers, but it will also be appreciated by lovers of the English style. The Kanlux BONSA LED light has an interesting distribution thanks to the shape and texture of the lampshade.

Enclosure material: Metal

Lampshade material: plastic

Kanlux

# EXATE LED

LED- DECKENLEUCHE ► CEILING-MOUNTED LED LIGHT FITTING

NEW



EXATE LED 17,5W NW



EXATE LED 17,5W NW | 37323 | 5905339373236 | 17,5 | LED | 1420 | 4000 | weiß | white

[V] 220-240 AC	[Hz] 50	[°] 120	[h] ≥20000	[h] 25000	ellipse ≤ 6x Nachdam	Ra 80	Hg	SMD
		IP 20	5+25			1,5	0,5m	
lm W 81	CE	EAC	UK CA					

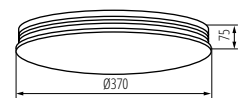

EXATE LED 17,5W NW



Die Kanlux EXATE LED Deckenleuchte ist eine Leuchte mit einer modernen Form. Das schlichte, minimalistische Design wird durch dünne Metallringe zart unterstrichen. Sie wird sowohl bei Liebhabern des modernen Stils als auch bei denen, die den Minimalismus schätzen, Anklang finden.

Gehäusematerial: Metall

Abdeckungsmaterial: Kunststoff

The Kanlux EXATE LED ceiling lamp is a lamp with a modern shape. The simple, minimalist design is delicately highlighted with thin metallic rings. It will find recognition among lovers of modern style, as well as those who appreciate minimalism.

Enclosure material: Metal

Lampshade material: plastic

# Kanlux SOLN LED

LED- DECKENLEUCHTE ► CEILING-MOUNTED LED LIGHT FITTING

NEW



SOLN LED 17,5W NW B/G

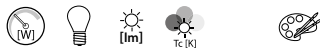

SOLN LED 17,5W NW B/G | 37324 | 5905339373243 | 17,5 | LED | 945 | 4000 | schwarz/ gold | black/gold

[V] 220-240 AC	[Hz] 50	[°] 120	≥20000	[h] 25000	ellipse ≤ für MacAdam	Ra 80	Hg	SMD
		IP 20		°C 5+25		1,5	0,5m	
lm W 54	CE	ERC	UK CA					

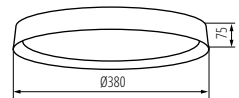

SOLN LED 17,5W NW B/G



Kanlux SOLN LED ist eine Leuchte, die die neuesten Einrichtungstrends widerspiegelt. Diese Lampe ist eine Referenz an den raffinierten Art-Deco-Stil, der mit Luxus, ausdrucksstarken Texturen und der Verwendung von glänzenden Oberflächen, einschließlich goldenen Accessoires, verbunden ist. Der schwarz-goldene, niedrige Schirm der Kanlux SOLN LED-Leuchte bleibt im Raum nicht unbenutzt und wird zu dessen zentraler Dekoration.

Gehäusematerial: Metall  
Abdeckungsmaterial: Kunststoff

Kanlux SOLN LED is a lighting fixture that reflects the latest interior design trends. This lamp is a reference to the refined art deco style, which is associated with luxury, expressive textures and the use of shiny surfaces, including gold accessories. The black and gold, low shade of the Kanlux SOLN LED lamp will not go unnoticed in the interior and will become its central decoration.

Enclosure material: Metal  
Lampshade material: plastic

# Kanlux AMAZI LED

LED- DECKENLEUCHTE ► CEILING-MOUNTED LED LIGHT FITTING

NEW



AMAZI LED 17,5W NW B



AMAZI LED 17,5W NW B | 37325 | 5905339373250 | 17,5 | LED | 925 | 4000 | schwarz | black

[V] 220-240 AC	[Hz] 50	[°] 120	≥20000	[h] 25000	ellipse ≤ für MacAdam	Ra 80	Hg	SMD
		IP 20		°C 5+25		1,5	0,5m	
lm W 53	CE	ERC	UK CA					

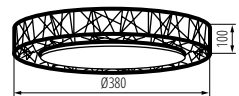

AMAZI LED 17,5W NW B



Kanlux AMAZI LED ist eine Leuchte, deren Design zukunftsweisend und bezaubernd ist. Die weiße Lampe und die geometrischen schwarzen Muster sind sehr ausdrucksstark und vertragen kein Unterstatement. Kanlux AMAZI LED spielt mit der Geometrie, spielt mit starken Linien und trägt eine Ladung Energie in sich.

Gehäusematerial: Metall  
Abdeckungsmaterial: Kunststoff

Kanlux AMAZI LED is a lamp whose design is forward-looking and enchanting. The white lamp and geometric black patterns are very expressive and do not tolerate any understatements. Kanlux AMAZI LED plays with geometry, plays with strong lines and carries a charge of energy.

Enclosure material: Metal  
Lampshade material: plastic

**Kanlux**

# VAND LED

LED- DECKENLEUCHE ▶ CEILING-MOUNTED LED LIGHT FITTING

**NEW**



VAND LED 17,5W NW W



VAND LED 17,5W NW B



Kanlux VAND LED ist eine moderne Version des traditionellen Deckenleuchte. Die schwarzen oder weißen Elemente (je nach Wahl des Modells) sorgen für Eleganz und einen Hauch von frischem Wind. Kanlux VAND LED spendet ein sehr dezentes Licht, so dass Sie in größeren Räumen mehrere dieser Lampen verwenden oder sie nur in Bereichen aufhängen können, in denen Sie keine starke Beleuchtung benötigen.

Gehäusematerial: Metall

Abdeckungsmaterial: Kunststoff

Kanlux VAND LED is a modern version of the traditional ceiling lamp. Black or white elements (depending on the model chosen) add elegance and a breath of freshness. Kanlux VAND LED gives very subtle light, so in larger rooms you can use several of these lamps or place it only in places where you do not need strong lighting.

Enclosure material: Metal

Lampshade material: plastic

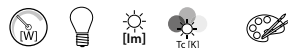

VAND LED 17,5W NW W	<b>37326</b>	5905339373267	17,5	LED	460	4000	weiß   white
VAND LED 17,5W NW B	<b>37327</b>	5905339373274	17,5	LED	460	4000	schwarz   black

[V]	[Hz]	[°]	[h]	[h]	[lm]	[Ra]	[Hg]
220-240 AC	50	120	≥20000	25000	≤ für Nachdäm	80	
SMD			IP 20		5+25		
1,5	0,5m	lm W 26	CE	EAR	UK CA		

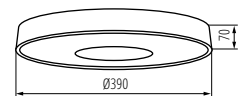

VAND LED 17,5W

# RIFA LED

LED- DECKENLEUCHTE ▶ CEILING-MOUNTED LED LIGHT FITTING



RIFA LED 17,5W GR/G



Kanlux RIFA LED ist eine einzigartige Lichtlösung. Sie unterscheidet sich von traditionellen Lampen dieser Art durch ihren Stoffschirm, der sie nicht nur praktisch, sondern vor allem dekorativ macht. Wir haben 4 Farbkombinationen vorbereitet, die zu Ihrer Einrichtung passen. Sie können zwischen zwei Lichtfarben wählen - neutralweiß oder warmweiß. Kanlux RIFA LED ist eine ideale Lösung für niedrige Innenräume, wo wir starkes Licht brauchen, aber nicht auf den dekorativen Charakter verzichten wollen.

Gehäusematerial: Metall

Abdeckungsmaterial: Kunststoff

Kanlux RIFA LED is a unique ceiling lamp. It is distinguished from traditional lamps of this type by a material lampshade, which makes it not only practical, but above all decorative. We have prepared 4 color combinations to match your interior, and you have a choice of two light colors - neutral or warm. Kanlux RIFA LED is an ideal solution for low ceiling interiors where we need strong light, but we do not want to give up its decorativeness.

Enclosure material: Metal

Lampshade material: plastic



RIFA LED 17,5W NW WW	<b>36460</b>	5905339364609	17,5	LED	1500	4000	weiß   white	
RIFA LED 17,5W WW WW	<b>36461</b>	5905339364616	17,5	LED	1450	3000	weiß   white	
RIFA LED 17,5W NW BW	<b>36462</b>	5905339364623	17,5	LED	1500	4000	schwarz/ weiß   black/white	
RIFA LED 17,5W WW BW	<b>36463</b>	5905339364630	17,5	LED	1450	3000	schwarz/ weiß   black/white	
RIFA LED 17,5W NW B/G	<b>36464</b>	5905339364647	17,5	LED	1500	4000	schwarz/ gold   black/gold	
RIFA LED 17,5W WW B/G	<b>36465</b>	5905339364654	17,5	LED	1450	3000	schwarz/ gold   black/gold	
RIFA LED 17,5W NW GR/G	<b>36466</b>	5905339364661	17,5	LED	1500	4000	grau/ gold   grey/ gold	
RIFA LED 17,5W WW GR/G	<b>36467</b>	5905339364678	17,5	LED	1450	3000	grau/ gold   grey/ gold	
RIFA LED 17,5W NW N1	<b>36468</b>	5905339364685	17,5	LED	1500	4000	weiß   white	
RIFA LED 17,5W WW N1	<b>36469</b>	5905339364692	17,5	LED	1450	3000	weiß   white	
RIFA LED 17,5W NW N2	<b>36508</b>	5905339365088	17,5	LED	1500	4000	braun   brown	
RIFA LED 17,5W WW N2	<b>36509</b>	5905339365095	17,5	LED	1450	3000	braun   brown	

[V] 220-240 AC	[Hz] 50	[°] 120	[h] ≥20000	[W] 25000	[mm] ≤ 6x MacAdam	Ra 80	Hg -	SMD
	IP 20		[°C] 5+25		[mm] 1,5	[m] 0,5m		

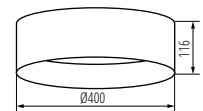

RIFA LED 17,5W

**Kanlux**

# RIFA LED

LED- DECKENLEUCHE ▶ CEILING-MOUNTED LED LIGHT FITTING



RIFA LED 17,5W W/W



RIFA LED 17,5W B/W



RIFA LED 17,5W B/G



RIFA LED 17,5W GR/G



RIFA LED 17,5W N1



RIFA LED 17,5W N2





# ARVOS LED

LED- DECKENLEUCHTE ▶ CEILING-MOUNTED LED LIGHT FITTING



ARVOS LED 37W CCT B



ARVOS LED 37W CCT W



Kanlux ARVOS LED ist eine Deckenleuchte, mit dem Sie die Stimmung in einem Raum verändern können, ohne die Lampe wechseln zu müssen. Dank der Fernbedienung können Sie ganz einfach die Farbe des Lichts und seine Intensität ändern, und am Abend können Sie den Nachtmodus einstellen, damit Sie leichter zur Ruhe kommen. Kanlux ARVOS LED ist eine Lampe, mit der Sie das Licht in jedem Raum an jede Situation und an die Tätigkeit, die Sie gerade ausüben, anpassen können.

Gehäusematerial: Stahl

Abdeckungsmaterial: PMMA

Kanlux ARVOS LED is a ceiling lamp that will help you change the mood in the room without having to change the lamp. Thanks to the remote control, you can easily change the light color and intensity, and in the evening you can set the night mode to make it easier to rest. Kanlux ARVOS LED is a lamp that allows you to adjust the light in every room to every situation and activity you are currently performing.

Enclosure material: steel

Lampshade material: PMMA



ARVOS LED 37W CCT B	<b>37330</b>	5905339373304	max 37	LED	max 2680 (4000K)	2700\4000\6500	schwarz   black
ARVOS LED 37W CCT W	<b>37331</b>	5905339373311	max 37	LED	max 2680 (4000K)	2700\4000\6500	weiß   white

[V]	[Hz]	[°]	[lm]	[h]	[lm]	[Ra]
220-240 AC	50	120	≥15000	25000	≤6/Machdim	80
Hg	SMD	IP 20	5+25	infrared		
	DIMMING function	0,5m				

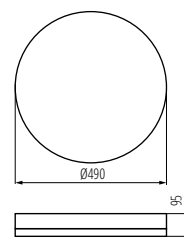

ARVOS

**Kanlux**

# JASMIN W

WANDLEUCHE ▶ WALL-MOUNTED LIGHT FITTING



JASMIN G/O-W



JASMIN WE-W



JASMIN W-W



JASMIN W/M-W



JASMIN B-W



JASMIN WE-W	<b>23756</b>	5905339237569	max 20	E27	LED	Wenge   wenge
JASMIN W-W	<b>23757</b>	5905339237576	max 20	E27	LED	Eiche weiß   white oak
JASMIN W/M-W	<b>23758</b>	5905339237583	max 20	E27	LED	weiß   white
JASMIN B-W	<b>29209</b>	5905339292094	max 20	E27	LED	schwarz   black
JASMIN G/O-W	<b>36443</b>	5905339364432	max 20	E27	LED	gold Eiche   golden oak

220-240 AC	50			IP 20	5+25		
1+1,5		0,5m					

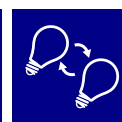

Die Kanlux JASMIN-Wandleuchten sind sorgfältig gefertigte Leuchten aus Holz, die die Möglichkeit einer interessanten Raumgestaltung bieten. Das effektvolle Gehäuse in Kombination mit Satin Glas, das für eine gleichmäßige Lichtverteilung sorgt, verleiht jedem Innenraum einen einzigartigen Charakter.

Gehäusematerial: Holz  
Abdeckungsmaterial: Glas

The Kanlux JASMIN wall lamps are carefully made, wooden holders which enable an arrangement of rooms in an interesting manner. The effective casing combined with satin glass which ensures even dispersal of light will give a unique character to each interior.

Enclosure material: Wood  
Lampshade material: glass

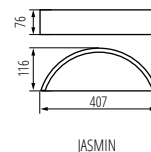

JASMIN



JASMIN 270-G/O



JASMIN 270-WE	<b>23120</b>	5905339231208	max 20	E27	LED	Wenge   wenge
JASMIN 370-WE	<b>23121</b>	5905339231215	2 x max 20	E27	LED	Wenge   wenge
JASMIN 470-WE	<b>23122</b>	5905339231222	3 x max 20	E27	LED	Wenge   wenge
JASMIN 270-W	<b>23123</b>	5905339231239	max 20	E27	LED	sonoma Eiche   sonoma oak
JASMIN 370-W	<b>23124</b>	5905339231246	2 x max 20	E27	LED	sonoma Eiche   sonoma oak
JASMIN 470-W	<b>23125</b>	5905339231253	3 x max 20	E27	LED	sonoma Eiche   sonoma oak
JASMIN 270-W/M	<b>23126</b>	5905339231260	max 20	E27	LED	weiß matt   matte white
JASMIN 370-W/M	<b>23127</b>	5905339231277	2 x max 20	E27	LED	weiß matt   matte white
JASMIN 470-W/M	<b>23128</b>	5905339231284	3 x max 20	E27	LED	weiß matt   matte white
JASMIN 470-B	<b>29205</b>	5905339292056	3 x max 20	E27	LED	schwarz   black
JASMIN 270-B	<b>29207</b>	5905339292070	max 20	E27	LED	schwarz   black
JASMIN 370-B	<b>29208</b>	5905339292087	2 x max 20	E27	LED	schwarz   black
JASMIN 270-G/O	<b>36440</b>	5905339364401	max 20	E27	LED	gold Eiche   golden oak
JASMIN 370-G/O	<b>36441</b>	5905339364418	2 x max 20	E27	LED	gold Eiche   golden oak
JASMIN 470-G/O	<b>36442</b>	5905339364425	3 x max 20	E27	LED	gold Eiche   golden oak

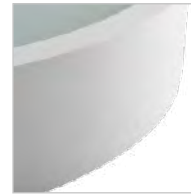

Originelle und zugleich stilvolle Kanlux JASMIN-Rundleuchten zeichnen sich durch ein modernes und ansprechendes Design aus. Das Gehäuse der Deckenleuchte besteht aus Holz und geätztem (Satin-) Glas, was eine gleichmäßige Lichtverteilung gewährleistet. Die klassische Kombination aus Holz und Glas macht sie zu einer sehr universellen Beleuchtungslösung.

Gehäusematerial: Holz  
Abdeckungsmaterial: Glas

The original and at the same time stylish round holders - Kanlux JASMIN are characterized by modern and attractive design. The casing of the ceiling light fixture is made of wood and etched (satin) glass which ensures even dispersal of light. The classic combination of wood and glass makes it a very universal lighting solution.

Enclosure material: Wood  
Lampshade material: glass

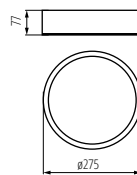

JASMIN 270

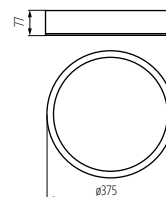

JASMIN 370

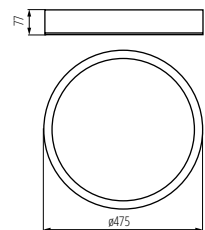

JASMIN 470

**Kanlux**  
**JASMIN**

DECKENLEUCHE ▶ CEILING LIGHT FITTING



JASMIN 270-G/O



JASMIN 370-G/O



JASMIN 470-G/O



JASMIN 270-WE



JASMIN 370-WE



JASMIN 470-WE



JASMIN 270-W



JASMIN 370-W



JASMIN 470-W



JASMIN 270-W/M



JASMIN 370-W/M



JASMIN 470-W/M



JASMIN 270-B



JASMIN 370-B



JASMIN 470-B

# DERATO

WAND-DECKENLEUCHTE ► WALL & CEILING LIGHTING FITTING



DERATO EL-10 B-SR



Die neue Wand-Deckenleuchte Kanlux DERATO bezieht sich in ihrer Form auf den RETRO-Stil. Diese Lampen sind in zwei Farben erhältlich: weiß und schwarz und haben 1 bis 4 Lichtpunkte. Die Kanlux DERATO erfüllt auch erfolgreich die Funktion einer Wandleuchte. Die großen Lampenschirme dieser Leuchten bieten auch große Möglichkeiten bei der Verwendung verschiedener Leuchtmittel mit E14-Sockel (max.8W). Kanlux DERATO-Leuchten verfügen über einen Schnellverschluss für eine bequeme und schnelle Montage. Ein weiterer Vorteil ist die Möglichkeit, den Lampenschirm an jeden beliebigen Ort zu richten (zwei Drehachsen: 350 und 110 Grad).

Gehäusematerial: Aluminiumlegierung

The new series of Kanlux DERATO luminaires is reminiscent of the RETRO style. These are luminaires in two colors: white and black, which have from 1 to 4 light points. Kanlux DERATO single-point lamps will also successfully fulfill the role of a wall lamp. Large lampshades of these luminaires also offer great possibilities for the use of various light sources with an E14 cap (max 8W). Kanlux DERATO luminaires use a quick mount terminals for convenient and quick installation. An additional advantage is the very wide possibility of directing the lampshade to any place (two rotation axes: 350 and 110 degrees).

Enclosure material: aluminum alloy



DERATO EL-10 B-SR	<b>35640</b>	5905339356406	max 8	schwarz/ silberfarben   black/ silver
DERATO EL-10 W-SR	<b>35641</b>	5905339356413	max 8	weiß/ silberfarben   white/ silver
DERATO EL-21 B-SR	<b>35642</b>	5905339356420	2x max 8	schwarz/ silberfarben   black/ silver
DERATO EL-21 W-SR	<b>35643</b>	5905339356437	2x max 8	weiß/ silberfarben   white/ silver
DERATO EL-30 B-SR	<b>35644</b>	5905339356444	3x max 8	schwarz/ silberfarben   black/ silver
DERATO EL-30 W-SR	<b>35645</b>	5905339356451	3x max 8	weiß/ silberfarben   white/ silver
DERATO EL-41 B-SR	<b>35646</b>	5905339356468	4x max 8	schwarz/ silberfarben   black/ silver
DERATO EL-41 W-SR	<b>35647</b>	5905339356475	4x max 8	weiß/ silberfarben   white/ silver

[V] 220-240 AC	[Hz] 50				IP 20		 5+25	
 350	 110		 0,5m	CE	EAC	UK CA		

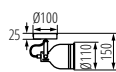

DERATO EL-10

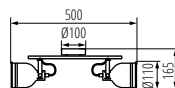

DERATO EL-21

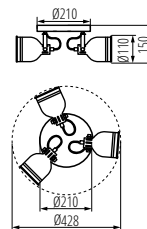

DERATO EL-30

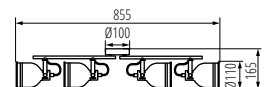

DERATO EL-41

**Kanlux**

# DERATO

WAND-DECKENLEUCHE ▶ WALL & CEILING LIGHTING FITTING



DERATO EL-10 B-SR



DERATO EL-10 W-SR



DERATO EL-21 B-SR



DERATO EL-21 W-SR



DERATO EL-30 B-SR



DERATO EL-30 W-SR



DERATO EL-41 B-SR



DERATO EL-41 W-SR



# Kanlux EVALO

WAND-DECKENLEUCHTE ► WALL & CEILING LIGHTING FITTING



EVALO EL-11 B-SR



EVALO EL-2I W-SR	<b>35692</b>	5905339356925	2 x max 10	weiß   white
EVALO EL-2I B-SR	<b>35693</b>	5905339356932	2 x max 10	schwarz   black
EVALO EL-3I W-SR	<b>35694</b>	5905339356949	3 x max 10	weiß   white
EVALO EL-3I B-SR	<b>35695</b>	5905339356956	3 x max 10	schwarz   black
EVALO EL-4O W-SR	<b>35696</b>	5905339356963	4 x max 10	weiß   white
EVALO EL-4O B-SR	<b>35697</b>	5905339356970	4 x max 10	schwarz   black
EVALO EL-4I W-SR	<b>35698</b>	5905339356987	4 x max 10	weiß   white
EVALO EL-4I B-SR	<b>35699</b>	5905339356994	4 x max 10	schwarz   black
EVALO EL-5I W-SR	<b>35688</b>	5905339356888	5 x max 10	weiß   white
EVALO EL-5I B-SR	<b>35689</b>	5905339356895	5 x max 10	schwarz   black
EVALO EL-11 W-SR	<b>35690</b>	5905339356901	max 10	weiß   white
EVALO EL-11 B-SR	<b>35691</b>	5905339356918	max 10	schwarz   black

[V] 220-240 AC	[Hz] 50		PAR16	GU10		IP 20	
5+25	320	90	1+2,5	0,5m			

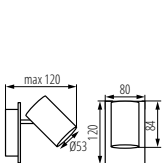

EVALO EL-11

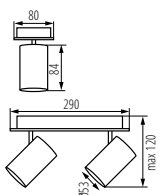

EVALO EL-2I

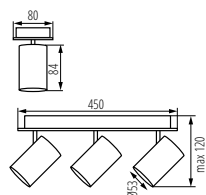

EVALO EL-3I

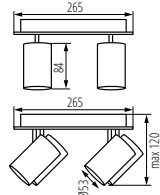

EVALO EL-4O

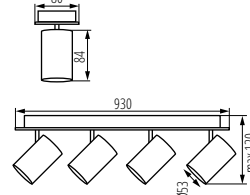

EVALO EL-4I

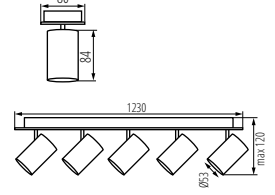

EVALO EL-5I



Kanlux EVALO ist eine Familie von Wand-Deckenleuchten. Mit seiner skandinavischen Schlichtheit und den silbernen Elementen ist er ein sehr eleganter Klassiker. Der schmale Schirm ist für GU10-Leuchtmittel geeignet (ein Saugnapf zur einfachen Installation ist im Lieferumfang enthalten). Die zwei Farben (schwarz und weiß) und die Anzahl von 1 bis 5 Lichtpunkten dieser Leuchten eröffnen viele Gestaltungsmöglichkeiten. Kanlux EVALO mit 1 Punkt ist eine ideale Wandleuchte über einem Schreibtisch, Bett oder hinter einem Sofa. Dank einer solchen Anordnung kann Kanlux EVALO sowohl als Haupt- als auch als Zusatzleuchte fungieren. Ein zusätzlicher Vorteil ist die Möglichkeit einer umfangreichen Einstellung der Lichtrichtung (zwei Drehachsen: 320 und 90 Grad).

Gehäusematerial: Aluminiumlegierung

Kanlux EVALO is a family of simple spots. Scandinavian simplicity and silver elements are a highly elegant classic. The narrow shade accommodates GU10 sources (we add a suction cup in the set, which facilitates their installation). Two colors (black and white) and the number of 1 to 5 light points of these luminaires open many arrangement possibilities. The Kanlux EVALO spotlight with 1 point is a perfect wall lamp above the desk, bed or behind the sofa. Thanks to this arrangement, Kanlux EVALO can act as the main and additional light. An additional advantage is the ability to adjust the direction of light incidence (two axes of rotation: 320 and 90 degrees).

Enclosure material: aluminum alloy

**Kanlux**

# EVALO

WAND-DECKENLEUCHE ▶ WALL & CEILING LIGHTING FITTING



EVALO EL-11 W-SR



EVALO EL-21 B-SR



EVALO EL-21 W-SR



EVALO EL-31 B-SR



EVALO EL-31 W-SR



EVALO EL-40 B-SR



EVALO EL-40 W-SR



EVALO EL-41 B-SR



EVALO EL-41 W-SR



EVALO EL-51 B-SR



EVALO EL-51 W-SR





# SONDA II

WAND-DECKENLEUCHE ► WALL & CEILING LIGHTING FITTING



SONDA II EL-10 B



SONDA II EL-10 B	<b>34920</b>	5905339349200	max 10	schwarz   black
SONDA II EL-10 W	<b>34921</b>	5905339349217	max 10	weiß   white
SONDA II EL-21 B	<b>34922</b>	5905339349224	2 x max 10	schwarz   black
SONDA II EL-21 W	<b>34923</b>	5905339349231	2 x max 10	weiß   white
SONDA II EL-31 B	<b>34924</b>	5905339349248	3 x max 10	schwarz   black
SONDA II EL-31 W	<b>34925</b>	5905339349255	3 x max 10	weiß   white
SONDA II EL-30 B	<b>34926</b>	5905339349262	3 x max 10	schwarz   black
SONDA II EL-30 W	<b>34927</b>	5905339349279	3 x max 10	weiß   white
SONDA II EL-40 B	<b>34928</b>	5905339349286	4 x max 10	schwarz   black
SONDA II EL-40 W	<b>34929</b>	5905339349293	4 x max 10	weiß   white

[V] 220-240 AC	[Hz] 50	 PAR16	 GU10	 IP 20	
 5+25	 330	 120	 1+2,5	 0,5m	

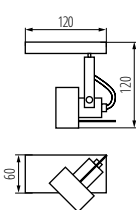

SONDA II EL-10

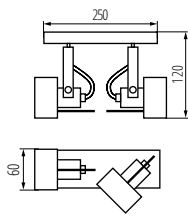

SONDA II EL-21

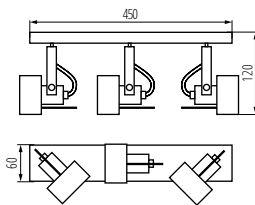

SONDA II EL-31

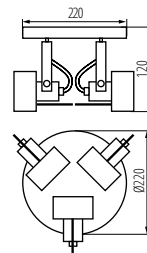

SONDA II EL-30

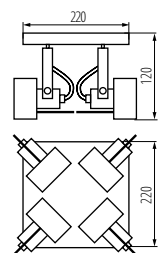

SONDA II EL-40



Kanlux SONDA II ist eine moderne Lampenserie, bei der Sie zwischen einem und vier Spots wählen können. Die moderne Form dieser Leuchten wird zu einer einzigartigen Dekoration jedes Interieurs. Ein zusätzlicher Vorteil der Kanlux SONDA II-Lampen ist die äußerst elegante Ausführung des Lampenschirms, der die Ränder der Lichtquelle verdeckt, wodurch die Linse der Glühbirne selbst sichtbar ist.

Gehäusematerial: Aluminiumlegierung

Kanlux SONDA II is a modern lamp series in which you can choose from 1 to 4 points of light. The modern shape of these luminaires will constitute a unique decoration of any interior. An additional advantage of Kanlux SONDA II lamps is the extremely elegant finish of the lampshade that hides the edges of the source of light so that only the bulb lens is visible.

Enclosure material: aluminum alloy

**Kanlux**

# SONDA II

WAND-DECKENLEUCHE ▶ WALL & CEILING LIGHTING FITTING



SONDA II EL-10 W



SONDA II EL-21 B



SONDA II EL-21 W



SONDA II EL-31 B



SONDA II EL-31 W



SONDA II EL-30 B



SONDA II EL-30 W



SONDA II EL-40 B



SONDA II EL-40 W





GALOBA EL-10 W



GALOBA EL-10 W	<b>33670</b>	5905339336705	max 35	weiß   white
GALOBA EL-10 B	<b>33671</b>	5905339336712	max 35	schwarz   black
GALOBA EL-2I W	<b>33674</b>	5905339336743	2 x max 35	weiß   white
GALOBA EL-2I B	<b>33675</b>	5905339336750	2 x max 35	schwarz   black
GALOBA EL-3I W	<b>33676</b>	5905339336767	3 x max 35	weiß   white
GALOBA EL-3I B	<b>33677</b>	5905339336774	3 x max 35	schwarz   black
GALOBA EL-4I W	<b>33678</b>	5905339336781	4 x max 35	weiß   white
GALOBA EL-4I B	<b>33679</b>	5905339336798	4 x max 35	schwarz   black
GALOBA EL-4I W	<b>33680</b>	5905339336804	4 x max 35	weiß   white
GALOBA EL-4I B	<b>33681</b>	5905339336811	4 x max 35	schwarz   black

<b>[V]</b> 220-240 AC	<b>[Hz]</b> 50					<b>IP</b> 20	
<b>ERC</b>	<b>UK CA</b>						

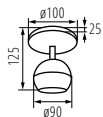

GALOBA EL-10

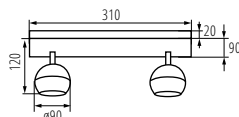

GALOBA EL-2I

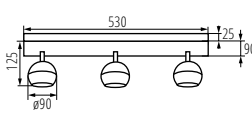

GALOBA EL-3I

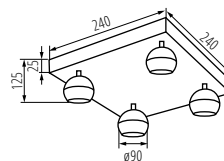

GALOBA EL-4I

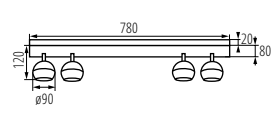

GALOBA EL-4I



Kanlux GALOBA ist eine komplette Beleuchtungsserie mit Pendelleuchten (GALOBA C), Wandleuchten (GALOBA W) sowie Wand- und Deckenleuchten. Kanlux GALOBA C Hängelampen können erfolgreich als Insel- oder Tischbeleuchtung eingesetzt werden, Wand- und Deckenleuchten (mit einem oder bis zu vier Spots) können in einem Wohnzimmer, einem Flur oder einem Schlafzimmer verwendet werden. Die Einrichtung wird durch Wandlampen mit einem Schalter im Sockel vervollständigt. Die gesamte Leuchtenserie Kanlux GALOBA hat einen abschraubbaren Lampenschirm, dank dem die Leuchtmittel schnell und bequem ausgetauscht werden können. Die maximale Höhe des Leuchtmittels beträgt bei GALOBA Leuchten 55 mm. Wir empfehlen die Lampen Kanlux SMART (S GU10) oder IQ-LED LIFE (IQ LED L GU10).

Maximale Höhe der Leuchtmittel 55mm

Gehäusematerial: Aluminiumlegierung

Kanlux GALOBA is a complete series of luminaires, including pendant lamps (GALOBA C), wall lamps (GALOBA W) and wall and ceiling fixtures. Kanlux GALOBA C pendant lamps can be successfully used for the lighting of islands or tables, while wall and ceiling lamps (from 1 to 4 points of light) can be used in a living room, hall or bedroom. The arrangement can be completed with wall lamps, which have a switch in the base. All luminaires from the Kanlux GALOBA series have a detachable lampshade thanks to which the light sources can be quickly and comfortably replaced.

Maximum light-source height 55mm

Enclosure material: aluminum alloy

**Kanlux**

# GALOBA

WAND-DECKENLEUCHE ▶ WALL & CEILING LIGHTING FITTING



GALOBA EL-10 B



GALOBA EL-21 W



GALOBA EL-21 B



GALOBA EL-31 W



GALOBA EL-31 B



GALOBA EL-40 W



GALOBA EL-40 B



GALOBA EL-41 W



GALOBA EL-41 B



# LAURIN

WAND-DECKENLEUCHTE ► WALL & CEILING LIGHTING FITTING



LAURIN EL-10 B



GALOBA EL-10 W	<b>33670</b>	5905339336705	max 35	weiß   white
GALOBA EL-10 B	<b>33671</b>	5905339336712	max 35	schwarz   black
GALOBA EL-2I W	<b>33674</b>	5905339336743	2 x max 35	weiß   white
GALOBA EL-2I B	<b>33675</b>	5905339336750	2 x max 35	schwarz   black
GALOBA EL-3I W	<b>33676</b>	5905339336767	3 x max 35	weiß   white
GALOBA EL-3I B	<b>33677</b>	5905339336774	3 x max 35	schwarz   black
GALOBA EL-4I W	<b>33678</b>	5905339336781	4 x max 35	weiß   white
GALOBA EL-4I B	<b>33679</b>	5905339336798	4 x max 35	schwarz   black
GALOBA EL-4I W	<b>33680</b>	5905339336804	4 x max 35	weiß   white
GALOBA EL-4I B	<b>33681</b>	5905339336811	4 x max 35	schwarz   black

[V] 220-240 AC	[Hz] 50				
 5°-25°	 310	 90	 1+2,5	 0,5m	

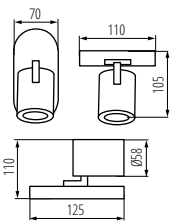

LAURIN EL-10

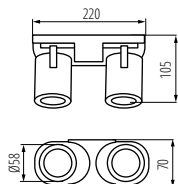

LAURIN EL-2I

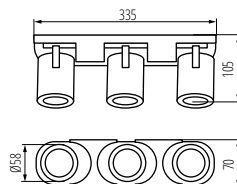

LAURIN EL-3I

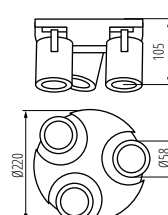

LAURIN EL-3I

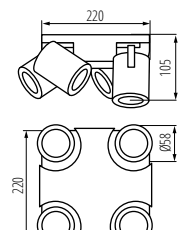

LAURIN EL-4I



Die Spotleuchten Kanlux LAURIN bieten eine sehr große Auswahl an Richtungsleuchten für Decken und Wände dar. Durch das einfache und minimalistische Design kann die Leuchte in vielen Räumen im Haus eingesetzt werden. Die freie Richtungseinstellung des Lichtstrahles ist ein weiterer Vorteil dieser Leuchten.

Gehäusematerial: Aluminiumlegierung

Kanlux LAURIN spotlights provide a very large selection of directional ceiling and wall lamps. The simple and minimalist design can be successfully used in many rooms in the house. Free adjustment of the luminous flux direction is an additional advantage of these fixtures.

Enclosure material: aluminum alloy

**Kanlux**

# LAURIN

WAND-DECKENLEUCHE ► WALL & CEILING LIGHTING FITTING



LAURIN EL-10 W



LAURIN EL-21 W



LAURIN EL-21 B



LAURIN EL-31 W



LAURIN EL-31 B

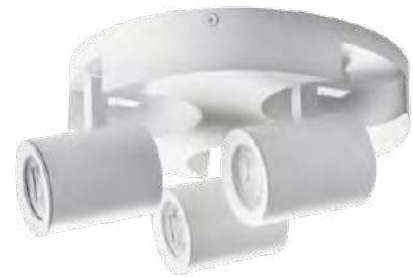

LAURIN EL-30 W



LAURIN EL-30 B



LAURIN EL-40 W



LAURIN EL-40 B





SEMPRA EL-11 B-SR



Kanlux SEMPRA ist eine elegante Serie von Wand- und Deckenleuchten in weiß-silber und in schwarz-silber. Dank der originellen Leiste, auf der die Lampenschirme montiert sind, können die Leuchten auf der Decke aber auch an der Wand montiert werden – das gibt uns neue Möglichkeiten, die Raumbeleuchtung zu gestalten. Eine vertikale Wandmontage der Leuchte mit z. B. 4-Spots ist auch eine sehr interessante Lösung.

Gehäusematerial: Stahl

Kanlux SEMPRA is a series of elegant spots in black and white or black and silver. Thanks to the original slat, on which the lampshades are mounted, all models will be perfect for both ceiling and wall applications - this gives us new possibilities of arranging room lighting. A very interesting solution is the possibility of vertical mounting of a luminaire with up to 4 light sources on the wall.

Enclosure material: steel



SEMPRA EL-11 W-SR	<b>33090</b>	5905339330901	max 10	weiß   white
SEMPRA EL-11 B-SR	<b>33091</b>	5905339330918	max 10	schwarz   black
SEMPRA EL-21 W-SR	<b>33092</b>	5905339330925	2 x max 10	weiß   white
SEMPRA EL-21 B-SR	<b>33093</b>	5905339330932	2 x max 10	schwarz   black
SEMPRA EL-31 W-SR	<b>33094</b>	5905339330949	3 x max 10	weiß   white
SEMPRA EL-31 B-SR	<b>33095</b>	5905339330956	3 x max 10	schwarz   black
SEMPRA EL-41 W-SR	<b>33096</b>	5905339330963	4 x max 10	weiß   white
SEMPRA EL-41 B-SR	<b>33097</b>	5905339330970	4 x max 10	schwarz   black

[V] 220-240 AC	[Hz] 50					



SEMPRA EL-11

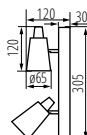

SEMPRA EL-21

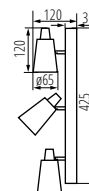

SEMPRA EL-31

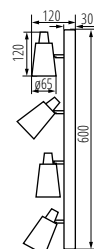

SEMPRA EL-41

**Kanlux**

# SEMPRA

WAND-DECKENLEUCHE ► WALL & CEILING LIGHTING FITTING



SEMPPRA EL-11 W-SR



SEMPPRA EL-21 W-SR



SEMPPRA EL-21 B-SR



SEMPPRA EL-31 W-SR



SEMPPRA EL-31 B-SR



SEMPPRA EL-41 W-SR



SEMPPRA EL-41 B-SR





# Kanlux ENALI

WAND-DECKENLEUCHTE ► WALL & CEILING LIGHTING FITTING



ENALI EL-10 W



NICHT VERFÜGBAR FÜR DEN DEUTSCHEN MARKT



ENALI EL-10 W	<b>28760</b>	5905339287601	max 10	weiß   white
ENALI EL-10 B	<b>28761</b>	5905339287618	max 10	schwarz   black
ENALI EL-21 W	<b>28762</b>	5905339287625	2 x max 10	weiß   white
ENALI EL-21 B	<b>28763</b>	5905339287632	2 x max 10	schwarz   black
ENALI EL-30 W	<b>28764</b>	5905339287649	3 x max 10	weiß   white
ENALI EL-30 B	<b>28765</b>	5905339287656	3 x max 10	schwarz   black
ENALI EL-31 W	<b>28766</b>	5905339287663	3 x max 10	weiß   white
ENALI EL-31 B	<b>28767</b>	5905339287670	3 x max 10	schwarz   black
ENALI EL-41 W	<b>28768</b>	5905339287687	4 x max 10	weiß   white
ENALI EL-41 B	<b>28769</b>	5905339287694	4 x max 10	schwarz   black

[V] 220-240 AC	[Hz] 50					IP 20	
 5+25	 310	 90		 1+2,5	 0,5m		

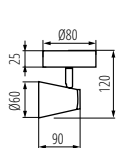

ENALI EL-10

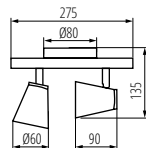

ENALI EL-21

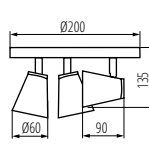

ENALI EL-30

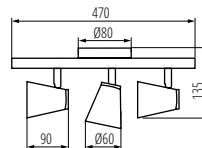

ENALI EL-31

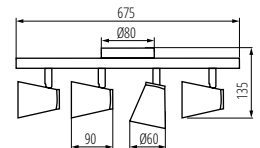

ENALI EL-41



Kanlux ENALI ist eine Serie von Punktleuchten (Decken- und Wandleuchten).

Gehäusematerial: Stahl  
Abdeckungsmaterial: Stahl

The Kanlux ENALI is a family of point fixtures (ceiling and wall). Thanks to the adjustable joints you can freely set the light-beam angle. The fixtures fit perfectly into Scandinavian style interiors, their shape will emphasise the character of retro interiors, and the chrome accessories will add a subtle touch to modern interiors.

Enclosure material: steel  
Lampshade material: steel



**Kanlux**

# ENALI

WAND-DECKENLEUCHE ▶ WALL & CEILING LIGHTING FITTING



ENALI EL-10 B



ENALI EL-21 W



ENALI EL-21 B



ENALI EL-30 W



ENALI EL-30 B



ENALI EL-31 W



ENALI EL-31 B



ENALI EL-41 W



ENALI EL-41 B





MILENO EL-10 B-AG



MILENO EL-10 B-AG	<b>29110</b>	5905339291103	max 10	schwarz/ gold   black/gold
MILENO EL-10 ASR-AN	<b>29111</b>	5905339291110	max 10	silber/ kupferfarben   silver/ copper
MILENO EL-30 B-AG	<b>29112</b>	5905339291127	3 x max 10	schwarz/ gold   black/gold
MILENO EL-30 ASR-AN	<b>29113</b>	5905339291134	3 x max 10	silber/ kupferfarben   silver/ copper
MILENO EL-2I B-AG	<b>29114</b>	5905339291141	2 x max 10	schwarz/ gold   black/gold
MILENO EL-2I ASR-AN	<b>29115</b>	5905339291158	2 x max 10	silber/ kupferfarben   silver/ copper
MILENO EL-3I B-AG	<b>29116</b>	5905339291165	3 x max 10	schwarz/ gold   black/gold
MILENO EL-3I ASR-AN	<b>29117</b>	5905339291172	3 x max 10	silber/ kupferfarben   silver/ copper
MILENO EL-4I B-AG	<b>29118</b>	5905339291189	4 x max 10	schwarz/ gold   black/gold
MILENO EL-4I ASR-AN	<b>29119</b>	5905339291196	4 x max 10	silber/ kupferfarben   silver/ copper

[V] 220-240 AC	[Hz] 50					IP 20	
 5+25	 300	 80		 1+2,5	 0,5m		

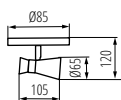

MILENO EL-10

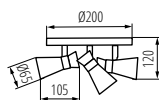

MILENO EL-30

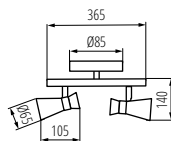

MILENO EL-2I

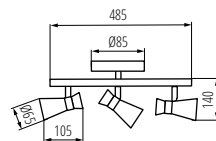

MILENO EL-3I

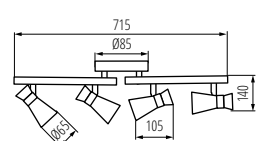

MILENO EL-4I



Kanlux MILENO ist die Antwort auf die neuesten Trends. Interessantes Design und originelle Form sind die Vorteile dieser Serie. Die Vielfalt der Modelle der Kanlux MILENO Leuchten ermöglicht eine breite Palette an Gestaltungsmöglichkeiten.

Gehäusematerial: Stahl

Kanlux MILENO follows the latest trends. The advantages of this series are its interesting design and original shape. The very-large number of Kanlux MILENO fixture models means many-more arrangement possibilities.

Enclosure material: steel

**Kanlux**

# MILENO

WAND-DECKENLEUCHE ▶ WALL & CEILING LIGHTING FITTING



MILENO EL-10 ASR-AN



MILENO EL-21 B-AG



MILENO EL-21 ASR-AN



MILENO EL-30 B-AG



MILENO EL-30 ASR-AN



MILENO EL-31 B-AG



MILENO EL-31 ASR-AN



MILENO EL-41 B-AG



MILENO EL-41 ASR-AN



# Kanlux BOLA LED

LED-NACHT-ORIENTIERUNGSLEUCHE/STECKDOSE ► LED PLUG-IN LAMP

NEW



BOLA LED 2xUSB WW W



BOLA LED 2xUSB WW W | 37397 | 5905339373977 | max 15 | 4 (0,22W) | 3000 | weiß | white

[V] 220-240 AC	[Hz] 50	15000	elliptisch ≤ für Nachdäm	Hg	SMD		
IP 20			CE	ERAC	UK CA		

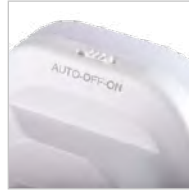

Kanlux BOLA LED ist eine steckerfertige LED-Lampe mit zwei USB-Anschlüssen (A und C). Die Lampe kann in einem von drei Modi betrieben werden - ON - permanent an/OFF - permanent aus/AUTO - schaltet sich bei geringer Lichtintensität ein (die Lampe hat einen Dämmerungssensor). Dank der USB-Anschlüsse kann die Lampe auch als Ladegerät für mobile Geräte verwendet werden. Kanlux BOLA gibt ein sanftes Nachtlicht (4 Lumen) mit einer warmweißen Temperatur ab.

Gehäusematerial: PC  
Abdeckungsmaterial: PC

Kanlux BOLA LED is a plug-in LED lamp with two USB ports (A and C). The lamp can operate in one of three modes - ON - permanently on/OFF - permanently off/AUTO - turns on at low light intensity (the lamp has a twilight sensor). Thanks to the USB ports, the lamp can also function as a charger for mobile devices. Kanlux BOLA emits gentle night light (4 lumens) at a warm white temperature.

Enclosure material: PC  
Lampshade material: PC

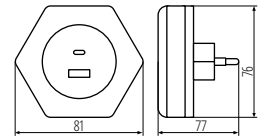

BOLA LED 2xUSB WW W

# Kanlux ULOV LED

LED-NACHT-ORIENTIERUNGSLEUCHE/STECKDOSE ► LED PLUG-IN LAMP

NEW



ULOV LED DIM WW W



ULOV LED DIM WW W | 37396 | 5905339373960 | 0,5 | 1-30 | 3000 | weiß | white

[V] 220-240 AC	[Hz] 50	elliptisch ≤ für Nachdäm	Hg	SMD			
IP 20			CE	ERAC	UK CA		

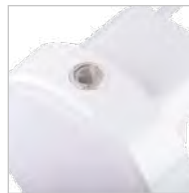

Kanlux ULOV LED ist eine steckerfertige Lampe, bei der die Lichtintensität stufenlos eingestellt werden kann. Sie hat einen eingebauten Dämmerungssensor (schaltet das Licht automatisch ein/aus). Dank ihres freundlichen Designs kann sie in den Steckdosen von Schlafzimmern, Kinderzimmern, Zimmern älterer Menschen oder in Fluren angebracht werden.

Gehäusematerial: Kunststoff  
Abdeckungsmaterial: Kunststoff

Kanlux ULOV LED is a plug-in lamp in which the light intensity can be smoothly adjusted. It has a built-in dusk sensor (automatically turns the light on and off). Its friendly design means that we can place it in bedrooms, children's rooms, elderly people's rooms or in corridors.

Enclosure material: plastic  
Lampshade material: plastic

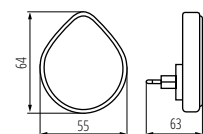

ULOV LED DIM WW W

Kanlux

# ORISA LED

LED-NACHT-ORIENTIERUNGSLEUCHTE/STECKDOSE ► LED PLUG-IN LAMP

NEW



ORISA LED WW W

ORISA LED WW B



ORISA LED WW W	<b>37394</b>	5905339373946	0,28	5	3000	weiß   white
ORISA LED WW B	<b>37395</b>	5905339373953	0,28	5	3000	schwarz   black

[VI]	[Hz]						
220-240 AC	50	20000	ellipse ≤ 6x Nachdam	Hg	SMD		
IP 20		lm W 18	CE	ERC	UK CA		



Kanlux ORISA LED ist eine elegante Steckerleuchte mit Dämmerungssensor (automatisches Ein- und Ausschalten in Abhängigkeit vom verfügbaren Tageslicht). Sie ist ideal für die Platzierung in Steckdosen im Schlafzimmer, Kinderzimmer, Seniorenzimmer oder in Fluren. Die Lampe gibt ein sanftes Licht ab (5 Lumen) und ihr elegantes Design wird eine zusätzliche Dekoration für den beleuchteten Bereich sein.

Gehäusematerial: PC

Kanlux ORISA LED is a stylish plug-in lamp with a twilight sensor (automatic switching on and off depending on the amount of available daylight). It is ideal for placing in bedrooms, children's rooms, elderly people's rooms or corridors. The lamp emits delicate light (5 lumens), and its elegant design will be an additional decoration of the illuminated place.

Enclosure material: PC

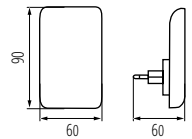

ORISA LED WW

Kanlux

# HOFI LED

LED-NACHT-ORIENTIERUNGSLEUCHTE/STECKDOSE ► LED PLUG-IN LAMP

NEW



HOFI LED WW W



HOFI LED WW W	<b>37393</b>	5905339373939	0,28	2	3000	weiß   white
---------------	--------------	---------------	------	---	------	--------------

[VI]	[Hz]						
220-240 AC	50	20000	ellipse ≤ 6x Nachdam	Hg	SMD		
IP 20		lm W 7	CE	ERC	UK CA		



Kanlux HOFI LED ist eine Stecklampe mit Dämmerungssensor, die sich für die Platzierung in Steckdosen in der Nähe von Treppen, in Fluren, Schlafzimmern und Kinderzimmern eignet. Die Lichtleistung der Lampe beträgt 2 Lumen (sehr weiches Licht), und sie kann auf zwei Arten in die Steckdose gesteckt werden, so dass das Licht nach unten oder nach oben fällt.

Gehäusematerial: PC

Abdeckungsmaterial: PC

Kanlux HOFI LED is a plug-in lamp with a twilight sensor, suitable for placing in sockets near the stairs, in corridors, bedrooms and children's rooms. The luminous flux of the lamp is 2 lumens (very delicate light), you can connect it to the socket in two ways, so that the light falls down or up.

Enclosure material: PC

Lampshade material: PC

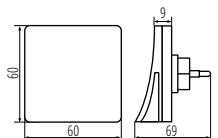

HOFI LED WW W

Kanlux

# CALIZA LED

LED-WANDELEUCHE ▶ LED WALL MOUNTED FITTING

NEW



CALIZA LED CCT W



CALIZA LED CCT W | 37390 | 5905339373908 max 2 weiß | white

3,7 DC ACCU	max 160	≥15000	25000	3000/4000/6500	≤ 6k MacAdam	Ra 80	SMD
	IP 20						
	max 80	CE	ENEC	UK CA			



Kanlux CALIZA LED ist eine moderne Wandleuchte mit einem Lichtstrom von 160 lm, die über USB C aufgeladen wird (220mm langes Kabel im Lieferumfang enthalten). Sie können den Sockel der Wandlampe mit Klebeband oder 2 Schrauben (im Set enthalten) an einer Wand oder einem Schrank befestigen, und Sie können den leuchtenden Teil selbst (Magnethalterung) zum Aufladen leicht abnehmen. Eine nützliche Funktion der Kanlux CALIZA LED-Wandleuchte ist die Änderung der Lichtintensität und -farbe. Die Kanlux CALIZA LED kann überall dort eingesetzt werden, wo die Installation nicht möglich ist, als Möbellampe oder als tragbare Lampe. Die Lampe hat eine maximale Betriebszeit von 5h.

Gehäusematerial: Kunststoff  
Abdeckungsmaterial: Kunststoff

Kanlux CALIZA LED is a modern wall lamp with a luminous flux of 160 lm, which is charged via USB C (the set includes a 220 mm cable). You can attach the base of the wall lamp to the wall or cabinet using tape or 2 screws (included in the set), and you can easily detach the lighting part (magnetic holder) for charging. A useful function of the Kanlux CALIZA LED wall lamp is the change of light intensity and color. Kanlux CALIZA LED will be useful in places where there is no installation, as a furniture or portable lamp. The lamp operating time is a maximum of 5 hours.

Enclosure material: plastic  
Lampshade material: plastic

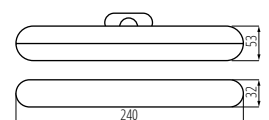

CALIZA LED CCT W

Kanlux

# GALOBA W

WANDLEUCHTE ► WALL-MOUNTED LIGHT FITTING



GALOBA W 1xGU10 B



GALOBA W 1xGU10 W



GALOBA W 1xGU10 W	<b>33672</b>	5905339336729	max 35	weiß   white
GALOBA W 1xGU10 B	<b>33673</b>	5905339336736	max 35	schwarz   black

[V]	[Hz]	PAR16	GU10	IP	20	5+25	335	315	0,75+1,5	0,5m	CE	EAC	UK CA
220-240 AC	50												

Kanlux GALOBA ist eine komplette Beleuchtungsreihe mit Pendelleuchten (GALOBA C), Wandleuchten (GALOBA W) sowie Wand- und Deckenleuchten. Kanlux GALOBA C Hängelampen können erfolgreich als Insel- oder Tischbeleuchtung eingesetzt werden, Wand- und Deckenleuchten (von 1-er bis 4-er Leuchten) können in einem Wohnzimmer, einem Flur oder einem Schlafzimmer verwendet werden. Die Einrichtung wird durch Wandlampen mit einem Schalter im Sockel vervollständigt. Die gesamte Leuchtenserie Kanlux GALOBA hat einen abschraubbaren Lampenschirm, dank dem die Leuchtmittel schnell und bequem ausgetauscht werden können.

Maximale Höhe der Leuchtmittel 55mm  
Gehäusematerial: Aluminiumlegierung

Kanlux GALOBA is a complete series of luminaires, including pendant lamps (GALOBA C), wall lamps (GALOBA W) and wall and ceiling fixtures. Kanlux GALOBA C pendant lamps can be successfully used for the lighting of islands or tables, while wall and ceiling lamps (from 1 to 4 points of light) can be used in a living room, hall or bedroom. The arrangement can be completed with wall lamps, which have a switch in the base. All luminaires from the Kanlux GALOBA series have a detachable lampshade thanks to which the light sources can be quickly and comfortably replaced.

Maximum light-source height 55 mm  
Enclosure material: aluminum alloy

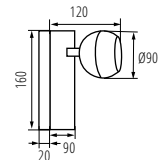

GALOBA W

Kanlux

# TONIL II LED

LED-WANDLEUCHTE ► LED WALL MOUNTED FITTING



TONIL II LED B



TONIL II LED W



TONIL II LED B	<b>32522</b>	5905339325228	3,3	schwarz   black
TONIL II LED W	<b>32523</b>	5905339325235	3,3	weiß   white

[V]	[Hz]	lm	°	h	Tc [K]	≤ für MacAdam	Ra	SMD	IP	20	121x51	max 370	25	0,25	59
220-240 AC	50	145	30	≥15000	20000	3000	80								



Kanlux TONIL LED II ist ein formschönes Wandleuchtenmodell mit integrierter Lichtquelle. Mit seinem flexiblen Gummiarm können Sie die Beleuchtung in die gewünschte Richtung lenken.

Gehäusematerial: Aluminiumlegierung  
Abdeckungsmaterial: Kunststoff

Kanlux TONIL LED II is a modest in form model with an integrated light source. Its flexible, rubber arm allows you to direct the lighting in the desired direction. At the same time, we can give it the desired shape.

Enclosure material: aluminum alloy  
Lampshade material: plastic

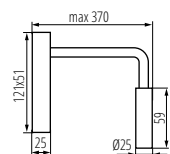

TONIL II LED



# AGZAR EL

WAND-DECKENLEUCHTE ► WALL & CEILING LIGHTING FITTING



AGZAR EL-10 B

AGZAR EL-10 W

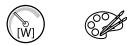

AGZAR EL-10 B	<b>36254</b>	5905339362544	max 5	schwarz   black
AGZAR EL-10 W	<b>36255</b>	5905339362551	max 5	weiß   white

[V]	[Hz]						
220-240 AC	50	E14		IP 20		5+25	
345	105	1+2,5	0,5m				

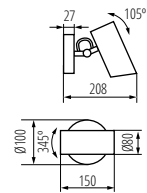

AGZAR EL 10

# AGZAR E14

TISCHLEUCHTE ► TABLE LAMP



AGZAR E14 B

AGZAR E14 W



AGZAR E14 B	<b>36250</b>	5905339362506	max 5	schwarz   black
AGZAR E14 W	<b>36251</b>	5905339362513	max 5	weiß   white

[V]	[Hz]								
220-240 AC	50	E14		IP 20		5+25			180
180		1,45	0,1m						

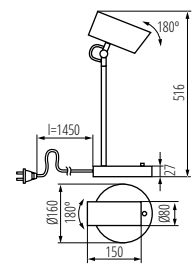

AGZAR E14



Kanlux AGZAR EL ist ein Einpunktstrahler aus Stahl. Ein unbestreitbarer Vorteil dieser Leuchten, abgesehen von ihrem modernen Design, ist die Möglichkeit, den Lampenschirm weit zu drehen. Die Drähte sind in ein Stoffgeflecht eingebettet und die Lampe ist mit viel Liebe zum Detail gefertigt. Kanlux AGZAR EL ist an die Lichtquelle mit E14-Sockel und maximaler Leistung von 5W angepasst.

Gehäusematerial: Stahl

Kanlux AGZAR EL is a single-point spot made of steel. The big advantage of these fittings, apart from modern design, is the ability to rotate the lampshade. The cables are braided and the lamp is made with attention to every detail. Kanlux AGZAR EL is adapted to a light source with an E14 cap and a maximum power of 5W.

Enclosure material: steel



Die Kanlux AGZAR E14 Tischleuchte ist eine Tischleuchte aus Stahl. Ihr unbestrittener Vorteil ist die Möglichkeit einer weiten Drehung des Lampenschirms. Die Drähte sind in ein Stoffgeflecht eingebettet und die Lampe ist mit viel Liebe zum Detail gefertigt. Kanlux AGZAR E14 ist an die Lichtquelle mit E14-Sockel und maximaler Leistung von 5W angepasst. Eine Lampe, die mit ihrem modernen Design sowohl die Liebhaber des klassischen Stils als auch die der Moderne begeistern wird. Die Aufmerksamkeit für jedes Detail und die Stahlkonstruktion machen diese Lampe zu einem Produkt der PREMIUM-Klasse.

Gehäusematerial: Stahl

The Kanlux AGZAR E14 table lamp is a table lamp made of steel. Its unquestionable advantage is the ability to rotate the lampshade. The cables are braided and the lamp is made with attention to every detail. Kanlux AGZAR E14 is adapted to a light source with an E14 cap and a maximum power of 5W. It is a lamp that will delight lovers of classic and modern styles with its modern design. Attention to every detail and steel structure make this lamp a PREMIUM class product.

Enclosure material: steel

# Kanlux LARATA EL

WAND-DECKENLEUCHE ► WALL & CEILING LIGHTING FITTING



LARATA EL-10 W

LARATA EL-10 B

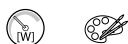

LARATA EL-10 W	<b>36262</b>	5905339362629	max 5	weiß   white
LARATA EL-10 B	<b>36263</b>	5905339362636	max 5	schwarz   black

<b>[V]</b> 220-240 AC	<b>[Hz]</b> 50		<b>E27</b>		<b>IP</b> 20			
					<b>CE</b>	<b>ERC</b>	<b>UK</b>	
330	100		1+2,5	0,5m				

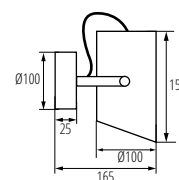

LARATA EL-10



HIGH  
quality  
finish

DESIGN  
unique

Kanlux LARATA EL ist ein Einpunktstrahler, der als Deckenleuchte, aber auch als Wandleuchte verwendet werden kann. Das Gehäuse ist aus Stahl gefertigt und bis ins kleinste Detail durchdacht. Die Lampen der Serie LARATA sind Premiumprodukte, die auch den Ansprüchen der größten Ästheten gerecht werden.

Gehäusematerial: Metall

Kanlux LARATA EL is a single-point spot that can be used as ceiling lighting, but also as wall lighting. The housing is made of steel with attention to every detail. LARATA lamps are premium products that meet the requirements of even the greatest aesthetes.

Enclosure material: Metal

# Kanlux LARATA E27

TISCHLEUCHE ► TABLE LAMP



LARATA E27 W

LARATA E27 B



LARATA E27 W	<b>36260</b>	5905339362605	max 5	weiß   white
LARATA E27 B	<b>36261</b>	5905339362612	max 5	schwarz   black

<b>[V]</b> 220-240 AC	<b>[Hz]</b> 50		<b>E27</b>		<b>IP</b> 20			
					<b>CE</b>	<b>ERC</b>	<b>UK</b>	
110			1,5	0,1m				

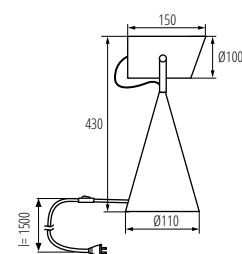

LARATA E27



HIGH  
quality  
finish

DESIGN  
unique

Kanlux LARATA E27 ist eine Tischleuchte, die aus Stahl gefertigt ist. Die Verarbeitung und das Gehäuse selbst verleihen der Leuchte Eleganz und ein modernes Aussehen. Die Tischleuchte Kanlux LARATA ist ein einzigartiges Produkt, das mit viel Liebe zum Detail hergestellt wird. Dank ihres Gewichts bleibt die Leuchte stabil und wackelt nicht. Der Arm wird mit zwei eleganten Schrauben eingestellt und das sichtbare Kabel ist in einem ästhetischen Geflecht verlegt.

Gehäusematerial: Metall

Kanlux LARATA E27 is a table lamp made of steel. The finish and the housing itself add elegance and a modern look to the lamp. The Kanlux LARATA table lamp is a unique product, made with attention to every detail. Due to its weight, the lamp remains stable on the surface and does not sway. The arm is adjusted with the help of two elegant screws, and the visible cable is placed in an aesthetic braid.

Enclosure material: Metal

# FLUXY LED IP44

LED-TISCHLEUCHTE ▶ LED TABLE LAMP



FLUXY LED IP44 GN



FLUXY LED IP44 W



FLUXY LED IP44 B



FLUXY LED IP44 BL



FLUXY LED IP44 Y



FLUXY LED IP44 W	<b>37310</b>	5905339373106	max 1,7	max 140	3000	weiß   white
FLUXY LED IP44 B	<b>37311</b>	5905339373113	max 1,7	max 140	3000	schwarz   black
FLUXY LED IP44 BL	<b>37312</b>	5905339373120	max 1,7	max 140	3000	blau   blue
FLUXY LED IP44 GN	<b>37313</b>	5905339373137	max 1,7	max 140	3000	grün   green
FLUXY LED IP44 Y	<b>37314</b>	5905339373144	max 1,7	max 140	3000	gelb   yellow

3,7 DC 18650 ACCU		80		DIMMING function	44	
0,1m	max 82					



Kanlux FLUXY LED ist eine Art multifunktionale kabellose Tischleuchte. Es sieht sehr modern und elegant aus, ist leicht und einfach zu transportieren und eignet sich dank der IP44-Klasse ideal für den Innen- und Außenbereich. Sie können die Kanlux FLUXY Lampe mit einem Knopf bedienen (Ein-/Aus-/Dimmfunktion) und über den USB-C-Anschluss aufladen.

Gehäusematerial: Kunststoff, Metall  
Abdeckungsmaterial: Kunststoff

Kanlux FLUXY LED is a type of multifunctional wireless table lamp. It has a very modern and elegant look, is light and easy to transport, and is ideal for indoor and outdoor use thanks to the IP44 class. You can operate the Kanlux FLUXY lamp with one button (on/off/dimming function) and charge it via the USB-C port.

Enclosure material: plastic, Metal  
Lampshade material: plastic

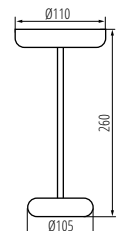

FLUXY LED IP44

# INITA LED IP54

LED-TISCHLEUCHTE ▶ LED TABLE LAMP

NEW



INITA LED IP54 B



INITA LED IP54 GN



INITA LED IP54 R



INITA LED IP54 Y



INITA LED IP54 W



INITA LED IP54 GN	<b>36320</b>	5905339363206	max 1,2	max 165	3000	grün   green
INITA LED IP54 B	<b>36321</b>	5905339363213	max 1,2	max 165	3000	schwarz   black
INITA LED IP54 R	<b>36322</b>	5905339363220	max 1,2	max 165	3000	rot   red
INITA LED IP54 Y	<b>36323</b>	5905339363237	max 1,2	max 165	3000	gelb   yellow
INITA LED IP54 W	<b>36324</b>	5905339363244	max 1,2	max 165	3000	weiß   white

<b>3,7 DC 18650 ACCU</b>	<b>IP 54</b>	<b>≥15000</b>	<b>25000</b>	<b>80</b>	<b>SMD</b>	<b>DIMMING function</b>
<b>Imax 138</b>						<b>0,1m</b>



Kanlux INITA LED ist eine neue Art von kabelloser Multifunktions Tischleuchte. Das Metallgehäuse, die weiche, matte Textur und die solide Farbe sind nur einige ihrer Qualitäten. Sie können die Kanlux INITA-Lampe mit einer einzigen Taste bedienen (Ein-/Aus-/Dimmfunktion) und sie über einen USB-Anschluss aufladen. Dank der Schutzart IP54 können Sie diese Lampe auch mit auf die Terrasse oder in den Garten nehmen. Sie können die Kanlux INITA-Tischleuchte schnell und einfach demontieren und in Ihr Gepäck packen, wenn Sie sie auf eine Reise mitnehmen möchten. Die Kanlux INITA können nicht mit einem Schnellladekabel aufgeladen werden - Verwenden Sie für die Aufladung: 5V DC, 1A.

Gehäusematerial: Metall

Abdeckungsmaterial: Aluminiumlegierung

Kanlux INITA LED is a new type of multifunctional, wireless table lamp. The metal body, delicate, matte texture and uniform color are just some of its advantages. You can operate the Kanlux INITA lamp with one button (on/off/dimming function) and charge it via the USB port. You can also take this lamp with you to the terrace or to the garden thanks to the IP54 tightness. The Kanlux INITA table lamp can be quickly and easily folded, unfolded and stored in your luggage - if you want to take it on a journey.

Enclosure material: Metal

Lampshade material: aluminum alloy

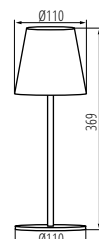

INITA LED IP 54

Kanlux

# EVALO TL

TISCHLEUCHTE ▶ TABLE LAMP

NEW



EVALO TL GU10 W-SR



EVALO TL GU10 B-SR



EVALO TL ist eine Tischleuchte aus der Kanlux EVALO-Leuchtsenserie. Die fast skandinavische Schlichtheit und die silbernen Gelenke schaffen einen sehr eleganten Klassiker. Der schmale Schirm kann mit GU10-Leuchtmitteln bestückt werden (ein Saugnapf zur einfachen Montage ist im Lieferumfang enthalten). Sie können die Leuchte Kanlux EVALO TL mit den Spots Kanlux EVALI und den Stehlampen Kanlux EVALO FL kombinieren.

Gehäusematerial: Aluminiumlegierung

EVALO TL is a table lamp belonging to the Kanlux EVALO lamp series. Scandinavian simplicity and silver joints create a highly elegant classic. The narrow lampshade houses GU10 light sources (the set includes a suction cup that makes their installation easier). You can combine the Kanlux EVALO TL lamp with Kanlux EVALI spots and Kanlux EVALO FL floor lamps.

Enclosure material: aluminum alloy



EVALO TL GU10 W-SR	<b>35785</b>	5905339357854	max 10	weiß   white
EVALO TL GU10 B-SR	<b>35786</b>	5905339357861	max 10	schwarz   black

[V]	[Hz]	PAR16	GU10	Light bulb icon	Wiring diagram icon	IP icon
220-240 AC	50	PAR16	GU10	Light bulb icon	Wiring diagram icon	IP icon
IP 20	House icon	Temperature icon	Light bulb icon	Angle icon	Angle icon	Light bulb icon
IP 20	House icon	5+25	Light bulb icon	320	90	Light bulb icon
Light bulb icon	1,5	0,1m	CE	EAC	UK	Light bulb icon

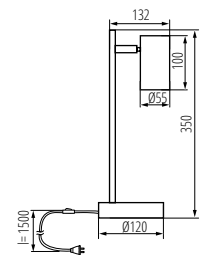

EVALO TL GU10

Kanlux

# EVALO FL

STEHLEUCHE ▶ FLOOR LAMP

NEW

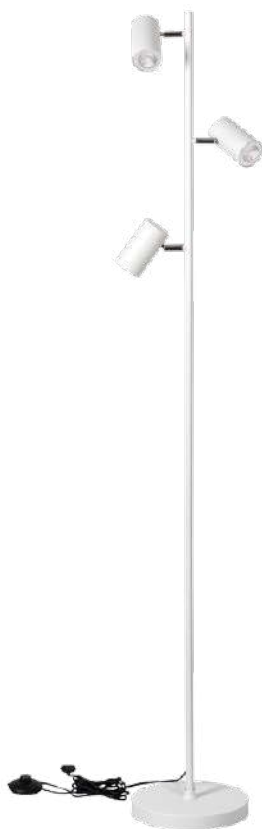

EVALO FL 3xGU10 W-SR

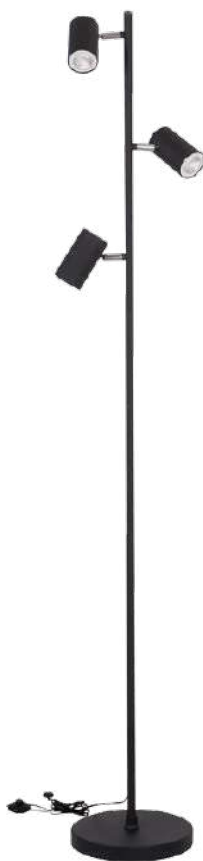

EVALO FL 3xGU10 B-SR



EVALO FL ist eine Stehleuchte aus der Kanlux EVALO-Leuchterserie. Ihre skandinavische Schlichtheit und die silbernen Gelenke machen sie zu einem sehr eleganten Klassiker. Der schmale Schirm (die Leuchte hat 3 Lichtpunkte) nimmt GU10-Leuchtmittel auf (Saugnapf zur einfachen Montage enthalten). Sie können die Leuchte Kanlux EVALO FL mit den Tischleuchten Kanlux EVALI spots und Kanlux EVALO TL kombinieren.

Gehäusematerial: Aluminiumlegierung

EVALO FL is a floor lamp belonging to the Kanlux EVALO lamp series. Scandinavian simplicity and silver joints create a highly elegant classic. The narrow lampshade (the lamp has 3 light points) houses GU10 light sources (a suction cup is included, which makes their installation easier). You can combine the Kanlux EVALO FL lamp with Kanlux EVALI spots and Kanlux EVALO TL table lamps.

Enclosure material: aluminum alloy



EVALO FL 3xGU10 W-SR	<b>35787</b>	5905339357878	3 x max 10	weiß   white
EVALO FL 3xGU10 B-SR	<b>35788</b>	5905339357885	3 x max 10	schwarz   black

[V] 220-240 AC	[Hz] 50	PAR16	GU10	Lightbulb icon	Lightbulb icon	Lightbulb icon
IP 20	House icon	Temperature icon 5+25	Lightbulb icon	Lightbulb icon	Lightbulb icon	Lightbulb icon
Lightbulb icon	Lightbulb icon	Lightbulb icon	Lightbulb icon	Lightbulb icon	Lightbulb icon	Lightbulb icon
Lightbulb icon	Lightbulb icon	Lightbulb icon	Lightbulb icon	Lightbulb icon	Lightbulb icon	Lightbulb icon

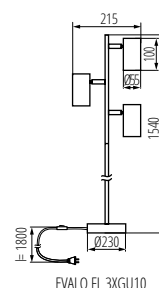

EVALO FL 3xGU10

Kanlux

# RAIBO E27

SCHREIBTISCHLEUCHE ▶ DESK LAMP



RAIBO E27 B



RAIBO E27 W



RAIBO E27 BL



RAIBO E27 Y



RAIBO E27 GN



RAIBO E27 PK



RAIBO E27 B	<b>36280</b>	5905339362803	max 5	schwarz   black
RAIBO E27 W	<b>36281</b>	5905339362810	max 5	weiß   white
RAIBO E27 BL	<b>36282</b>	5905339362827	max 5	blau   blue
RAIBO E27 Y	<b>36283</b>	5905339362834	max 5	gelb   yellow
RAIBO E27 GN	<b>36284</b>	5905339362841	max 5	grün   green
RAIBO E27 PK	<b>36285</b>	5905339362858	max 5	rosa   pink

<b>[VI]</b> 220-240 AC	<b>[Hz]</b> 50			<b>IP</b> 20	 0,1m			
 190				<b>CE</b>	<b>EMC</b>	<b>UK</b>		



Kanlux RAIBO ist eine modische Schreibtischlampe im Retro-Stil. Sie ist in 4 Pastellfarben sowie in den beliebten Farben Schwarz und Weiß erhältlich. Im Sockel ist ein Organizer mit einer Halterung eingebaut, in die wir unser Telefon, unsere Stifte oder unsere Brille stecken können. Der große Lampenschirm, der eine E27-Glühbirne aufnehmen kann, sorgt für eine breite Lichtverteilung. Der Retro-Einfluss ist hier offensichtlich, aber auch die Liebe zum Detail und die solide Verarbeitung (Stahl). Wir haben auch auf die Unterseite der Lampe geachtet und eine Schaumstoffunterlage hinzugefügt, damit die Lampe keine Kratzer auf dem Schreibtisch hinterlässt.

Gehäusematerial: Metall

Kanlux RAIBO is a fashionable retro desk lamp. It is available in 4 pastel colors as well as in the popular black and white. The base has a built-in organizer in which you can put a phone, pens or glasses. A large lampshade, in which we can fit a bulb with an E27 base, is a wide light distribution. The retro influence is visible here, but also attention to detail and a solid finish (steel). We also paid attention to the underside of the lamp and added a foam pad to keep the lamp from scratching the desk.

Enclosure material: Metal

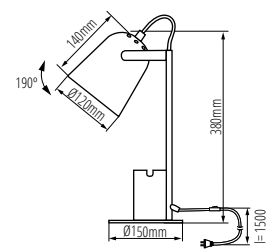

RAIBO E27

# Kanlux JUSI E27

TISCHLEUCHTE ► TABLE LAMP



JUSI E27 W



JUSI E27 B



JUSI E27 W	<b>36270</b>	5905339362704	max 5	weiß   white
JUSI E27 B	<b>36271</b>	5905339362711	max 5	schwarz   black

[V]	[Hz]	E27	IP	5+25	180°
220-240 AC	50		20		



Die Kanlux JUSI E27 Tischleuchte kann erfolgreich als Schreibtischlampe, Nachtlampe oder als zusätzliche Raumbelichtung eingesetzt werden. Das Design dieser Lampe ist so universell, dass sie sowohl in das Jugendzimmer als auch in das Wohn- oder Schlafzimmer passt. Dank der Möglichkeit, die E27-Glühbirne zu wechseln, bestimmen wir die Lichtleistung selbst. Das Stahlgehäuse und der Ein/Aus-Schalter am Netzkabel sind weitere Merkmale. Eine Neuheit ist die Möglichkeit, den Arm um 40 Grad zu neigen, während der Lampenschirm selbst um 180 Grad gekippt werden kann.

Gehäusematerial: Metall

The Kanlux JUSI E27 table lamp can be successfully used as a desk lamp, bedside lamp, or as additional room lighting. The design of this lamp is so universal that it will fit perfectly into a youth room as well as a living room or bedroom. We decide on the power of light ourselves thanks to the possibility of replacing the bulb with E27 cap. A steel housing and a switch mounted on the power cord are its additional advantages. A novelty is the possibility of tilting the arm by 40 degrees, the lampshade itself can be tilted additionally by 180 degrees.

Enclosure material: Metal

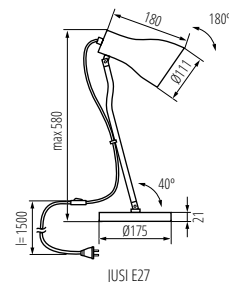

# Kanlux NEDIA E14

TISCHLEUCHTE ► TABLE LAMP



NEDIA E14 B



NEDIA E14 W



NEDIA E14 B	<b>34475</b>	5905339344755	max 10	schwarz   black
NEDIA E14 W	<b>34476</b>	5905339344762	max 10	weiß   white

[V]	[Hz]	E14	IP	5+25	320
220-240 AC	50		20		



KANLUX NEDIA ist eine Tischleuchte für für austauschbare Leuchtmittel mit E14-Sockel. Die stilvolle Form dieser Lampe wird als funktionelle Ausstattung eines Arbeitszimmers und Arbeitsplatzes nützlich sein. Kanlux NEDIA verleiht auch Schlafzimmern und Büros einen dekorativen Charakter. Sie kann auch eine unverzichtbare zusätzliche Beleuchtung in Ihrem Wohnzimmer sein. Ihr zusätzlicher Vorteil ist ein verstellbares Gelenk in silberner Farbe und die hohe Qualität der Verarbeitung der Lampe. Kanlux NEDIA verfügt über einen mechanischen Ein/Aus-Schalter, der sich am Netzkabel befindet.

Gehäusematerial: Stahl

KANLUX NEDIA is a table lamp with a replaceable light source with an E14 cap. The stylish form of this lamp will prove to be a functional accessory for your learning and working space. Kanlux NEDIA will also add decorativeness to a bedroom and a study. It can also constitute invaluable additional lighting for your living room. An additional advantage is an adjustable silver joint and the high quality of workmanship. Kanlux NEDIA has a mechanical ON/OFF switch located on the power cord.

Enclosure material: steel

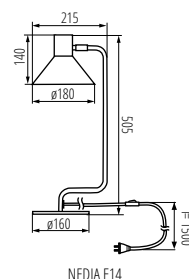



# Kanlux PIXA

SCHREIBTISCHLEUCHE ▶ DESK LAMP



PIXA KT-40-W

PIXA KT-40-B



PIXA KT-40-W	<b>19300</b>	5905339193001	max 40	weiß   white
PIXA KT-40-B	<b>19301</b>	5905339193018	max 40	schwarz   black

[V] 220-240 AC	[Hz] 50			IP 20	 0,1m			
 360	 180	 lm 1,6						

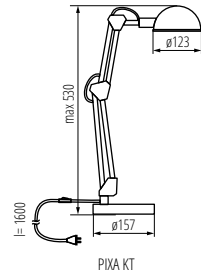

PIXA KT

# Kanlux HERON II LED

LED-SCHREIBTISCHLEUCHE ▶ LED DESK LAMP



HERON II LED B

HERON II LED W



HERON II LED B	<b>27602</b>	5905339276025	4,8	schwarz   black	430	4000
HERON II LED W	<b>27603</b>	5905339276032	4,8	weiß   white	430	4000

[V] 220-240 AC	[Hz] 50	 110	 ≥15000	 20000	 elliptisch ≤ 60 MacAdam	 80		
	IP 20	 0,1m			 360	 180	 lm 1,7	
	 90							

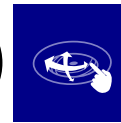

HERON II ist eine neue Version der bekannten LED-Schreibtischlampe mit geringerem Stromverbrauch, aber höherer Lichtleistung. Sie zeichnet sich vor allem durch die außergewöhnliche Einstellbarkeit des Lichtstrahls aus, dank ihrer verstellbaren Gelenke – der Leuchtenarm ist frei drehbar. HERON II LED verfügt über einen Ein-/Ausschalter am Lampenschirm und eine Klemme, mit der Sie den Sockel an der Kante einer Tischplatte oder eines Regals befestigen können. Kanlux HERON II LED erfreut sich großer Beliebtheit bei Menschen, die modernes, schlichtes Design schätzen. Sie wird sich sowohl auf dem Schreibtisch eines Schülers oder Studenten als auch bei Arbeiten, die eine Beleuchtung erfordern, als nützlich erweisen.

Gehäusematerial: Aluminiumlegierung  
Abdeckungsmaterial: Kunststoff

HERON II is a new version of the well-known LED desk lamp with lower power consumption but higher light output. It is distinguished above all by the extraordinary adjustability of the light beam, thanks to its adjustable joints - the lamp arm can be rotated freely. HERON II LED has an on/off switch located on the lamp shade and a clamp that allows you to fix the base to the edge of a table top or shelf. Kanlux HERON II LED is very popular among people who appreciate modern, austere design. It will prove useful on a pupil's or student's desk, as well as at work requiring lighting.

Enclosure material: aluminum alloy  
Lampshade material: plastic

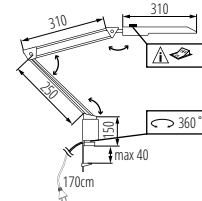

HERON II LED

# Kanlux ZARA

SCHREIBTISCHLEUCHE ▶ DESK LAMP



ZARA HR-40-B



ZARA HR-40-SR	<b>07560</b>	5905339075604	max 40	silber   silver
ZARA HR-40-B	<b>07561</b>	5905339075611	max 40	schwarz   black
ZARA HR-40-W	<b>07564</b>	5905339075642	max 40	weiß   white

NEW

[V]	[Hz]			IP				
220-240 AC	50			20	0,2m		E14	
360	360	1,5						



ZARA HR-40-SR



ZARA HR-40-W

NEW



Die Kanlux ZARA-Serie von Schreibtischlampen ist ein Kultmodell, das sich seit Jahren ungebrochener Beliebtheit erfreut. Durch ihre Schlichtheit und ihr klassisches Aussehen passt diese Lampe perfekt auf jeden Schreibtisch. Die klassischen Farben und die Möglichkeit, ein Leuchtmittel mit E14-Gewinde hinzuzufügen, sind ebenfalls ihre Vorteile.

Gehäusematerial: Stahl  
Abdeckungsmaterial: Stahl

The family of Kanlux ZARA desk lamps is a cult model that has enjoyed unflagging popularity for years. Thanks to its simplicity and classic look, this lamp will look perfect on any desk. Its advantage is also the classic colors and the possibility of self-adjustment of the light source with the E14 socket.

Enclosure material: steel  
Lampshade material: steel

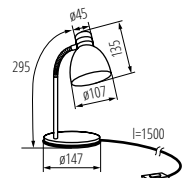

ZARA HR-40

# Kanlux SUZI

SCHREIBTISCHLEUCHE ▶ DESK LAMP



SUZI HR-60-B



SUZI HR-60-SR	<b>07150</b>	5905339071507	max 40	silber   silver
SUZI HR-60-B	<b>07151</b>	5905339071514	max 40	schwarz   black
SUZI HR-60-BL	<b>07152</b>	5905339071521	max 40	blau   blue
SUZI HR-60-PK	<b>07153</b>	5905339071538	max 40	rosa   pink
SUZI HR-60-W	<b>07154</b>	5905339071545	max 40	weiß   white

NEW

[V]	[Hz]			IP				
220-240 AC	50			20	0,2m		E27	
360	360	1,5						



SUZI HR-60-SR



SUZI HR-60-BL



SUZI HR-60-PK



SUZI HR-60-W

NEW



Kanlux SUZI ist eine einfache Schreibtischlampe. Sie ist in mehreren einheitlichen Farbversionen erhältlich. Kanlux SUZI hat einen verstellbaren Arm und einen Clip, mit dem Sie die Lampe an der Schreibtischkante oder im Regal befestigen können.

Flexibler Arm  
Montage mit Clip  
Gehäusematerial: Kunststoff  
Abdeckungsmaterial: Stahl

Kanlux SUZI is a simple desk lamp. It is available in several uniform colour versions. Kanlux SUZI has an adjustable arm and a clip thanks to which you can fix the lamp on a desk edge or on a shelf.

Flexible exterior arm  
Clip-on installation  
Enclosure material: plastic  
Lampshade material: steel

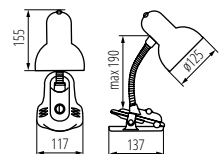

SUZI HR-60

Kanlux

# PREDA LED

LED-SCHREIBTISCHLEUCHE ▶ LED DESK LAMP



PREDA LED B



PREDA LED W



Kanlux PREDA ist eine multifunktionale Schreibtischlampe. Sie zeichnet sich durch ihren (für eine Schreibtischlampe) hohen Lichtstrom aus - bis zu 620 Lumen (weißes Modell). Es zeichnet sich durch einen sanften Farbwechsel (Slider) und die Möglichkeit aus, die Farbe des Lichts zu ändern. Einzigartig ist die Möglichkeit, den Lampenarm um 45 Grad um seine eigene Achse zu schwenken. Die Lampe ist mit einem USB-Anschluss zum Aufladen mobiler Geräte ausgestattet. Sie können diese Lampe erfolgreich zur Beleuchtung eines Schülertisches oder eines größeren Arbeitsbereiches einsetzen. Es kann auch in Schönheitssalons verwendet werden.

Gehäusematerial: Kunststoff  
 Abdeckungsmaterial: Kunststoff  
 Material des Auslegers: Kunststoff

Kanlux PREDA is a multifunctional desk lamp. It is distinguished by a high (as for desk lamps) luminous flux - up to 620 lumens (white model). It is characterized by a smooth color change (slider) and the ability to change the color of the light. A unique feature is the possibility of deflecting the lamp arm around its axis by 45 degrees. The lamp is equipped with a USB port, thanks to which we can charge mobile devices. This lamp can be successfully used to illuminate a student's desk or a larger workplace. It can also be used in beauty salons.

Enclosure material: plastic  
 Lampshade material: plastic  
 Extension-arm material: plastic



PREDA LED B	<b>35780</b>	5905339357809	max 7,3	schwarz   black	max 570	3000/5000/6500
PREDA LED W	<b>35781</b>	5905339357816	max 7,3	weiß   white	max 620	3000/5000/6500

[V]	[Hz]	[lm]	[h]	[Ra]	[SMD]	[DIMMING function]
220-240 AC	50	15000	25000	80	SMD	function
[IP]	[°]	[°]	[°]	[°]	[°]	[lm]
20	45	150	30	150	30	1,8
CE	ERC	UK CA				

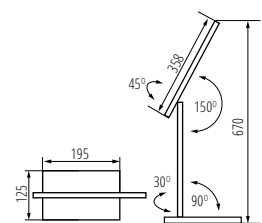

PREDA LED

# Kanlux REXAR LED

LED-SCHREIBTISCHLEUCHTE ► LED DESK LAMP



REXAR LED B

REXAR LED W

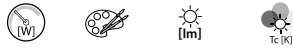

REXAR LED W	<b>33070</b>	5905339330703	max 7	weiß   white	max 420	3000\4000\6500
REXAR LED B	<b>33071</b>	5905339330710	max 7	schwarz   black	max 370	3000\4000\6500

[V] 220-240 AC	[Hz] 50	[°] 100	[lm] ≥15000	[h] 25000	[lm] ≤6lx Nachtdam	Ra 80	SMD	[lm] 1,8
DIMMING function	IP 20	0,1m	180	1,8				
CE	EAC	UK CA						

changeable  
COLOUR  
temperature

DIMMING  
function

USB  
PORT

HIGH  
quality  
finish

Kanlux REXAR ist eine Schreibtischlampe mit einem minimalistischem, elegantem Design und vielen Vorzügen. Die Farbtemperatur, wie auch die Lichtintensität sind einstellbar, und am USB-Anschluss kann z.B. das mobile Gerät aufgeladen werden. Durch einen beweglichen und biegbaren Lampenarm beansprucht die Lampe nicht viel Platz, und kann auch als minimalistische Dekoration dienen.

Gehäusematerial: Aluminiumlegierung, Kunststoff

Kanlux REXAR desk lamp combines a minimalist, elegant design and plenty of functions. You can adjust the colour of the light and its intensity to suit your preferences, as well as use the USB port in order to charge a mobile device. Once it is switched off, a folded lamp does not occupy much space and serves as an uncluttered decoration.

Enclosure material: aluminum alloy, plastic

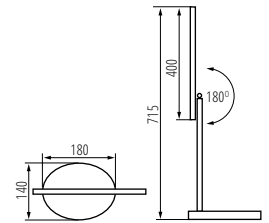

REXAR LED

# Kanlux FRANCO II / FRANCO LED

LED-SCHREIBTISCHLEUCHTE ► LED DESK LAMP



FRANCO B

FRANCO W



FRANCO 15LED SMD KT-W	<b>22340</b>	5905339223401	max 6,5	weiß   white	max 390	3000
FRANCO 15LED SMD KT-B	<b>22341</b>	5905339223418	max 6,5	schwarz   black	max 390	3000

[V] 220-240 AC	[Hz] 50	[°] 100	[lm] ≥10000	[h] 20000	[lm] ≤6lx Nachtdam	Ra 80	SMD	[lm] 1,8
DIMMING function	IP 20	0,1m	360	360	1,8			
CE	EAC	UK CA						



WARM  
white

DIMMING  
function

FLEXIBLE  
arm

Kanlux FRANCO ist eine stromlinienförmige, dezente und zugleich elegante Stehleuchte. Ideal als Schreibtischbeleuchtung, aber auch als zusätzliche Raumbeleuchtung oder Nachttischlampe. Eine praktische Lösung ist die Möglichkeit, die Lichtintensität anzupassen, damit wir die Helligkeit der Beleuchtung an unsere Bedürfnisse und die Tageszeit anpassen können.

Anzgestattet mit einem im Sockel platzierten Sensor, dank dem die Leuchte durch Berühren ein- / ausgeschaltet oder die Lichtintensität (3 Helligkeitsstufen) eingestellt werden kann

Gehäusematerial: Kunststoff

Abdeckungsmaterial: Kunststoff

Kanlux FRANCO is a streamlined, in terms of shape, discrete and at the same time elegant standing lamp. It works perfectly as the desk lighting and also as the additional lighting of a room or a bedside lamp. A possibility of adjusting the intensity of light is a convenient solution, thanks to which you can adapt brightness of light to own needs and time of day.

The base plate is provided with a sensor that enables switching on/off the lamp or controlling the light intensity by touch (3 brightness levels)

Enclosure material: plastic

Lampshade material: plastic

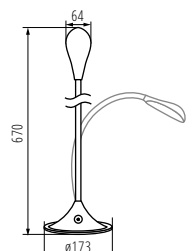

FRANCO

# GLOZO DSO

EINBAU-DOWNLIGHT ► RING FOR SPOTLIGHT FITTINGS



GLOZO DSO W/W



GLOZO DSO B/W



GLOZO DSO G/W



GLOZO DSO SR/W



GLOZO DSO B/B



GLOZO DSO G/B



GLOZO DSO SR/B



GLOZO DSO W/B



Kanlux GLOZO ist eine große Familie von Einbau-Downlight. Sie haben ein modulares Gehäuse: einen Sockel in zwei Formen und Farben und einen Reflektor in 4 Farben in matt oder flash. Dadurch ergeben sich zahlreiche Gestaltungsmöglichkeiten für das Nebeneinander von gleichen oder unterschiedlichen Farblösungen.

Dekorring ohne keramische Fassung  
Gehäusematerial: Aluminiumlegierung

Kanlux GLOZO is a large family of decorative rings. They have a modular housing: a base in two shapes and colors and a reflector in 4 colors in mat or mirror finish. It gives us a lot of possibilities to arrange the combination of the same or different color solutions.

Decorative ring without a ceramic frame  
Enclosure material: aluminum alloy



GLOZO DSO W/W	<b>36218</b>	5905339362186	max 10	weiß   white	nicht verfügbar   none
GLOZO DSO B/W	<b>36219</b>	5905339362193	max 10	schwarz/ weiß   black/white	nicht verfügbar   none
GLOZO DSO G/W	<b>36220</b>	5905339362209	max 10	gold/ weiß   gold/ white	nicht verfügbar   none
GLOZO DSO SR/W	<b>36221</b>	5905339362216	max 10	silber / weiß   silver/ white	nicht verfügbar   none
GLOZO DSO W/B	<b>36222</b>	5905339362223	max 10	weiß/ schwarz   white/ black	nicht verfügbar   none
GLOZO DSO B/B	<b>36223</b>	5905339362230	max 10	schwarz   black	nicht verfügbar   none
GLOZO DSO G/B	<b>36224</b>	5905339362247	max 10	gold/ schwarz   gold/ black	nicht verfügbar   none
GLOZO DSO SR/B	<b>36225</b>	5905339362254	max 10	silber/ schwarz   silver/ black	nicht verfügbar   none

<b>[VI]</b>								
<b>12 AC; 12 DC; 220-240 AC</b>		<b>Gx5,3/GU10</b>			<b>IP 20</b>			
<b>Ø75</b>	<b>0,5m</b>							

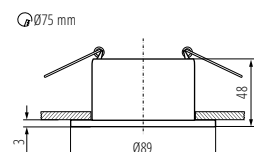

GLOZO DSO

# GLOZO DSL

EINBAU-DOWNLIGHT ► RING FOR SPOTLIGHT FITTINGS



GLOZO DSL W/W



Kanlux GLOZO ist eine große Familie von Einbau-Downlight. Sie haben ein modulares Gehäuse: einen Sockel in zwei Formen und Farben und einen Reflektor in 4 Farben in matt oder flash. Dadurch ergeben sich zahlreiche Gestaltungsmöglichkeiten für das Nebeneinander von gleichen oder unterschiedlichen Farblösungen.

Dekorring ohne keramische Fassung  
Gehäusematerial: Aluminiumlegierung

Kanlux GLOZO is a large family of decorative rings. They have a modular housing: a base in two shapes and colors and a reflector in 4 colors in mat or mirror finish. It gives us a lot of possibilities to arrange the combination of the same or different color solutions.

Decorative ring without a ceramic frame  
Enclosure material: aluminum alloy



GLOZO DSL B/W



GLOZO DSL G/W



GLOZO DSL SR/W



GLOZO DSL B/B



GLOZO DSL G/B



GLOZO DSL SR/B



GLOZO DSL W/B



GLOZO DSL W/W	<b>36210</b>	5905339362100	max 10	weiß   white	nicht verfügbar   none
GLOZO DSL B/W	<b>36211</b>	5905339362117	max 10	schwarz/ weiß   black/white	nicht verfügbar   none
GLOZO DSL G/W	<b>36212</b>	5905339362124	max 10	gold/ weiß   gold/ white	nicht verfügbar   none
GLOZO DSL SR/W	<b>36213</b>	5905339362131	max 10	silber / weiß   silver/ white	nicht verfügbar   none
GLOZO DSL W/B	<b>36214</b>	5905339362148	max 10	weiß/ schwarz   white/ black	nicht verfügbar   none
GLOZO DSL B/B	<b>36215</b>	5905339362155	max 10	schwarz   black	nicht verfügbar   none
GLOZO DSL G/B	<b>36216</b>	5905339362162	max 10	gold/ schwarz   gold/ black	nicht verfügbar   none
GLOZO DSL SR/B	<b>36217</b>	5905339362179	max 10	silber/ schwarz   silver/ black	nicht verfügbar   none

<b>IV</b>					<b>IP 20</b>	
<b>12 AC; 12 DC; 220-240 AC</b>		<b>6x5,3/GU10</b>			<b>IP 20</b>	<b>5+25</b>
<b>Ø75</b>		<b>0,5m</b>			<b>CE</b>	

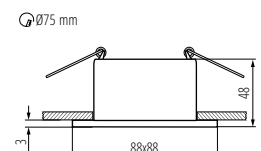

GLOZO DSL

# FELINE DSO

EINBAU-DOWNLIGHT ▶ RING FOR SPOTLIGHT FITTINGS

NEW



FELINE DSO B/B



FELINE DSO W/B



FELINE DSO G/B



FELINE DSO B/W



FELINE DSO G/W



FELINE DSO W/W



FELINE DSO B/B	<b>37250</b>	5905339372505	max 10	schwarz   black	nicht verfügbar   none
FELINE DSO G/B	<b>37251</b>	5905339372512	max 10	gold/ schwarz   gold/ black	nicht verfügbar   none
FELINE DSO W/B	<b>37252</b>	5905339372529	max 10	weiß/ schwarz   white/ black	nicht verfügbar   none
FELINE DSO W/W	<b>37253</b>	5905339372536	max 10	weiß   white	nicht verfügbar   none
FELINE DSO G/W	<b>37254</b>	5905339372543	max 10	gold/ weiß   gold/ white	nicht verfügbar   none
FELINE DSO B/W	<b>37255</b>	5905339372550	max 10	schwarz/ weiß   black/white	nicht verfügbar   none

[VI]							
12 AC; 12 DC; 220-240 AC					IP 20		5+25
Ø77 (mm)					CE	UK CA	
	0,5m						



Kanlux FELINE DSO sind runde, elegante Deckenleuchten. Es gibt 6 verschiedene Farbversionen, die zu den Innenräumen passen, wo sie eine sichtbare Dekoration werden.

Dekorativer Ring ohne Keramikfassung.  
Gehäusematerial: Aluminiumlegierung

Kanlux FELINE DSO are round, elegant ceiling eyes. There are 6 different color versions available, which you can match to the interior, where they will become a visible decoration.

Decorative ring without a ceramic frame.  
Enclosure material: aluminum alloy

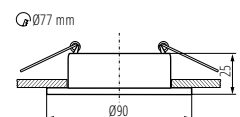

FELINE DSO

# FELINE DSL

EINBAU-DOWNLIGHT ► RING FOR SPOTLIGHT FITTINGS

NEW



FELINE DSL B/B



FELINE DSL W/B



FELINE DSL G/B



FELINE DSL B/W



FELINE DSL G/W



FELINE DSL W/W



FELINE DSL B/B	<b>37256</b>	5905339372567	max 10	schwarz   black	nicht verfügbar   none
FELINE DSL G/B	<b>37257</b>	5905339372574	max 10	gold/ schwarz   gold/ black	nicht verfügbar   none
FELINE DSL W/B	<b>37258</b>	5905339372581	max 10	weiß/ schwarz   white/ black	nicht verfügbar   none
FELINE DSL W/W	<b>37259</b>	5905339372598	max 10	weiß   white	nicht verfügbar   none
FELINE DSL B/W	<b>37260</b>	5905339372604	max 10	schwarz/ weiß   black/white	nicht verfügbar   none
FELINE DSL G/W	<b>37261</b>	5905339372611	max 10	gold/ weiß   gold/ white	nicht verfügbar   none

<b>IV</b>					<b>IP 20</b>			
<b>12 AC; 12 DC; 220-240 AC</b>					<b>IP 20</b>			
					<b>CE</b>	<b>UK CA</b>		
<b>Ø77</b>	<b>0,5m</b>				<b>CE</b>	<b>UK CA</b>		



Kanlux FELINE DSL sind quadratische, elegante Deckenleuchten. Es gibt 6 verschiedene Farbversionen, die zu den Innenräumen passen, wo sie zu einer sichtbaren Dekoration werden.

Dekorativer Ring ohne Keramikfassung.  
Gehäusematerial: Aluminiumlegierung

Kanlux FELINE DSL is a square, elegant ceiling mesh. There are 6 different color versions available, which you can match to the interior, where they will become a visible decoration.

Decorative ring without a ceramic frame  
Enclosure material: aluminum alloy

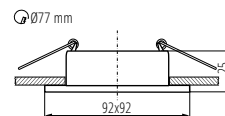

FELINE DSL



# Kanlux GOVIK

EINBAU-DOWNLIGHT ► RING FOR SPOTLIGHT FITTINGS



GOVIK DSO-W



KANLUX GOVIK ist eine neue Spotleuchte in einem einzigartigen Design. Durch die Verwendung eines matten Acryldiffusors wird das Licht gestreut und das Leuchtmittel unsichtbar gemacht. Die Leuchte sieht aus wie eine miniatur-integrierte Aufbauleuchte.

Dekorring ohne keramische Fassung  
Gehäusematerial: Aluminiumlegierung

KANLUX GOVIK is a new holder for building in with a unique structure. The mat, acrylic lampshade diffuses light and makes the installed light source be invisible. The holder looks like a miniature integrated surface mounted luminaire.

Decorative ring without a ceramic frame  
Enclosure material: aluminum alloy



GOVIK DSO-W/G	<b>29231</b>	5905339292315	max 10	weiß/ gold   white/ gold	nicht verfügbar   none
GOVIK DSO-B/G	<b>29232</b>	5905339292322	max 10	schwarz/ gold   black/ gold	nicht verfügbar   none
GOVIK-ST DSO-W/G	<b>29233</b>	5905339292339	max 10	weiß/ gold   white/ gold	nicht verfügbar   none
GOVIK-ST DSO-B/G	<b>29234</b>	5905339292346	max 10	schwarz/ gold   black/ gold	nicht verfügbar   none
GOVIK DSO-W	<b>29235</b>	5905339292353	max 10	weiß   white	nicht verfügbar   none
GOVIK DSO-B	<b>29236</b>	5905339292360	max 10	schwarz   black	nicht verfügbar   none
GOVIK-ST DSO-B	<b>29237</b>	5905339292377	max 10	schwarz   black	nicht verfügbar   none
GOVIK-ST DSO-W	<b>29238</b>	5905339292384	max 10	weiß   white	nicht verfügbar   none

<b>[VI]</b>					<b>IP</b> <b>20</b>	
<b>12 AC; 12 DC; 220-240 AC</b>						
<b>Ø67</b>	<b>0,5m</b>	<b>MR16/PAR16</b>				

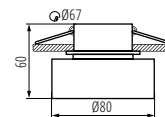

GOVIK DSO

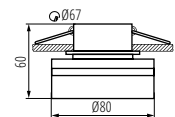

GOVIK-ST DSO

**Kanlux**  
**GOVIK**

EINBAU-DOWNLIGHT ► RING FOR SPOTLIGHT FITTINGS



GOVIK DSO-W/G



GOVIK-ST DSO-W/G



GOVIK DSO-B/G



GOVIK-ST DSO-B/G



GOVIK-ST DSO-B



GOVIK-ST DSO-W



GOVIK DSO-B



# CHIRO GU10

EINBAU-DOWNLIGHT ► CEILING-MOUNTED SPOTLIGHT FITTING



CHIRO GU10 DTO-B



CHIRO GU10 DTL-B



CHIRO GU10 DTO-W



Kanlux CHIRO GU10 ist eine völlig neue Kategorie dekorativer Beleuchtung. Diese Leuchte vom Typ SPOT kann dank der Halterung wie eine normale Spotleuchte in einer abgehängten Decke installiert werden. Das einzigartige Design und die Montage dieser Leuchte sind ihre größten Vorzüge.

Gehäusematerial: Aluminiumlegierung

Kanlux CHIRO GU10, is a completely new category of decorative lighting. It is the ceiling-mounted lamp which can be mounted in a suspended ceiling just like a typical spotlight fitting. Unique design and assembly of this lamp are its largest assets.

Enclosure material: aluminum alloy



CHIRO GU10 DTO-W	<b>29310</b>	5905339293107	max 10	weiß   white	in einer Achse   in one axis	90
CHIRO GU10 DTO-B	<b>29311</b>	5905339293114	max 10	schwarz   black	in einer Achse   in one axis	90
CHIRO GU10 DTL-B	<b>29313</b>	5905339293138	max 10	schwarz   black	in einer Achse   in one axis	90

[V]	[Hz]	GU10	⊕	↕	IP	⌚	⌚	[°]	(mm)
220-240 AC	50	GU10			20	5+25	340	Ø70	
	0,75-1,5	0,5m	PAR16	CE	UK CA				

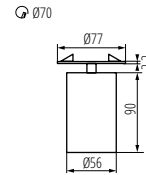

CHIRO GU10 DTO

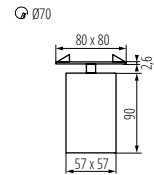

CHIRO GU10 DTL

# Kanlux SPAG

EINBAU-DOWNLIGHT ► RING FOR SPOTLIGHT FITTINGS



SPAG C B-G



SPAG S B-G



SPAG D W-G



SPAG D B-G



Kanlux SPAG sind elegante Dekorringe. Die Kombination aus Gold und klassischem Schwarz oder Weiß verleiht diesen Leuchten einen subtilen Charme. Dank der verschiedenen Formen der Kanlux SPAG-Leuchten können Sie in ihren Wohnzimmern, aber auch in eleganten Restaurants und Hotelsuiten einzigartige und geschmackvolle Beleuchtungsarrangements schaffen.

Dekorring ohne keramische Fassung  
Gehäusematerial: Aluminiumlegierung

Kanlux SPAG are elegant decorative rings. A combination of gold and classic black or white adds a subtle charm to these holders. Thanks to diverse shapes of the Kanlux SPAG holders, you can create unique and stylish lighting arrangements in your living rooms, elegant restaurants and hotel apartments.

Decorative ring without a ceramic frame  
Enclosure material: aluminum alloy



SPAG S B/G	<b>27322</b>	5905339273222	max 10	schwarz/ gold   black/gold	nicht verfügbar   none
SPAG C B/G	<b>27324</b>	5905339273246	max 10	schwarz/ gold   black/gold	nicht verfügbar   none
SPAG D B/G	<b>27326</b>	5905339273260	max 10	schwarz/ gold   black/gold	nicht verfügbar   none
SPAG D W/G	<b>27327</b>	5905339273277	max 10	weiß/ gold   white/ gold	nicht verfügbar   none

[V]	⊕	↕	IP	⌚	⌚
12 AC; 12 DC; 220-240 AC	Gx5.3/GU10		20	5+25	
Ø61-62	0,5m	MR16/PAR16	CE	UK CA	

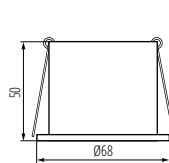

SPAG D

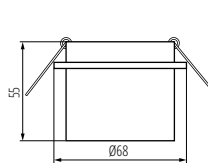

SPAG S

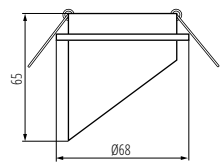

SPAG C

# Kanlux MINI RITI

EINBAU-DOWNLIGHT ► CEILING-MOUNTED SPOTLIGHT FITTING



MINI RITI GU10 W/G



MINI RITI GU10 B/G



MINI RITI GU10 B/W



MINI RITI GU10 B/B



MINI RITI GU10 W/W

MODERN  
design

HIGH  
quality  
finish

Kanlux MINI RITI ist eine kleinere, etwas niedrigere Version der beliebten Kanlux RITI Leuchte. Kanlux MINI RITI ist eine Leuchte aus Aluminium. Die sandgestrahlte Gehäusestruktur ist zusätzlich mit mattem Lack in elegantem Schwarz oder Weiß überzogen. Die Kanlux MINI RITI Leuchte zeichnet sich durch gute Verarbeitung und modernes Design aus. Wir können sie erfolgreich als eigenständige Beleuchtung einsetzen oder mehrere Leuchten kombinieren. Das leicht zu öffnende Gehäuse gewährleistet einen einfachen Austausch des Leuchtmittels. Wir können die Farbe des Reflektors frei wählen: Gold-Kupfer mit einem glänzenden Pigment, weiß oder schwarz. Die MINI RITI Leuchte ist eine Halbeinbau-Leuchte und ist für die Unterputzmontage konzipiert.

Gehäusematerial: Aluminiumlegierung

Kanlux MINI RITI is a smaller, slightly lower version of the popular Kanlux RITI luminaire. We prepared it in two versions - black and white, but each of them has several reflector colours - white, black or gold. We are sure that such a wide choice ensures that Kanlux MINI RITI can more easily be adapted to the type of interior in which it is placed. If you want to go for extravagance, you can combine different colours of the luminaires or combine them with Kanlux RITI. Together, they will create a harmonious yet unusual room luminaire. Kanlux MINI RITI can also be combined with Kanlux RITI REF reflectors. Enclosure material: aluminum alloy



MINI RITI GU10 B/G	27575	5905339275752	max 10	schwarz/ gold   black/gold	nicht verfügbar   none
MINI RITI GU10 W/G	27576	5905339275769	max 10	weiß/ gold   white/ gold	nicht verfügbar   none
MINI RITI GU10 B/W	27577	5905339275776	max 10	schwarz/ weiß   black/white	nicht verfügbar   none
MINI RITI GU10 B/B	27578	5905339275783	max 10	schwarz   black	nicht verfügbar   none
MINI RITI GU10 W/W	27579	5905339275790	max 10	weiß   white	nicht verfügbar   none

[V] 220-240 AC	[Hz] 50	GU10	IP 20	5+25	[mm] Ø68*71
1+2,5	0,5m	PAR16	CE	UK CA	

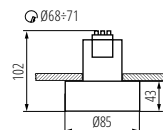

MINI RITI GU10

# Kanlux MINI GORD

EINBAU-DOWNLIGHT ► RING FOR SPOTLIGHT FITTINGS



MINI GORD DLP-50-W



MINI GORD DLP-50-B



MODERN  
design

Dies ist die Mini-Version der GORD-Leuchten. Eine perfekte Alternative für diejenigen, die Einbauleuchten an einer abgehängten Decke einsetzen möchten, denn die Installation funktioniert wie, bei versenkten Einbauleuchten. Ein weiterer Vorzug der MINI GORD Leuchten ist der um 30° verstellbare Winkel.

Dekorring ohne keramische Fassung

Gehäusematerial: Aluminiumlegierung, Stahl

The Mini version of the GORD fixtures. A perfect alternative for people who want to use surface-mounted fixtures in a suspended ceiling, because the manner of installation is the same as for recessed-eyelet fixtures. An additional advantage is the angular adjustment of the MINI GORD fixtures within the range of 30°.

Decorative ring without a ceramic frame

Enclosure material: aluminum alloy, steel



MINI GORD DLP-50-W	28780	5905339287809	max 10	weiß   white	in einer Achse   in one axis	30
MINI GORD DLP-50-B	28781	5905339287816	max 10	schwarz   black	in einer Achse   in one axis	30

[V] 12 AC; 12 DC; 220-240 AC	6x5,3/GU10	IP 20	5+25	Ø85	0,5m	MR16/PAR16	CE	UK CA
---------------------------------	------------	----------	------	-----	------	------------	----	----------

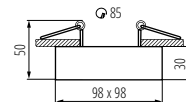

MINI GORD DLP-50

# Kanlux MINI BORD

EINBAU-DOWNLIGHT ► RING FOR SPOTLIGHT FITTINGS



MINI BORD DLP-50-W



MINI BORD DLP-50-B



Dies ist die Mini-Version der BORD-Leuchten. Eine perfekte Alternative für diejenigen, die Einbauleuchten an einer abgehängten Decke einsetzen möchten, denn die Installation funktioniert wie bei versenkten Einbauleuchten. Ein weiterer Vorzug der MINI BORD Leuchten ist der um 30° verstellbare Winkel.

Dekorring ohne keramische Fassung  
Gehäusematerial: Aluminiumlegierung, Stahl

The Mini version of the BORD fixtures. A perfect alternative for people who want to use surface-mounted fixtures in a suspended ceiling, because the manner of installation is the same as for recessed-eyelet fixtures. An additional advantage is the angular adjustment of the MINI BORD fixtures within the range of 30°.

Decorative ring without a ceramic frame  
Enclosure material: aluminum alloy, steel



MINI BORD DLP-50-W	<b>28782</b>	5905339287823	max 10	weiß   white	in einer Achse   in one axis	30
MINI BORD DLP-50-B	<b>28783</b>	5905339287830	max 10	schwarz   black	in einer Achse   in one axis	30

<b>[V]</b> 12 AC; 12 DC; 220-240 AC						

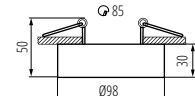

MINI BORD DLP-50

# Kanlux TINY BORD

EINBAU-DOWNLIGHT ► RING FOR SPOTLIGHT FITTINGS

**NEW**



TINY BORD DTO-B



TINY BORD DTO-B/G



TINY BORD DTO-W



TINY BORD DTO-W/G



Kanlux TINY BORD ist eine Mini-Version der beliebten Aufbauleuchten Kanlux MINI BORD. Ähnlich wie bei der Familie Kanlux MINI BORD handelt es sich bei KANLUX TINY BORD um einen dekorativen Ring, der bündig montiert wird. Kanlux TINY BORD garantieren eine einzigartige Beleuchtung, die es ermöglicht, ausgewählte Elemente des Raumdekors zu betonen und eine angenehme Atmosphäre zu schaffen. Das moderne und schlichte Design macht die Ringe sowohl für Wohn- als auch für Geschäftsräume geeignet. Es stehen mehrere Farbkombinationen zur Auswahl, so dass für jeden etwas dabei ist.

Gehäusematerial: Aluminiumlegierung

Kanlux TINY BORD is a mini version of the popular Kanlux MINI BORD surface-mounted fixtures. Like the Kanlux MINI BORD family, Kanlux TINY BORD is a decorative ring, flush-mounted. Kanlux TINY BORD guarantee unique lighting that allows you to highlight selected elements of the room's design and create a pleasant atmosphere. The modern and simple design makes the rings suitable for both residential and commercial interiors. We have several color combinations to choose from, the models with a gold ring deserve special attention.

Enclosure material: aluminum alloy



TINY BORD DTO-B	<b>37165</b>	5905339371652	max 10	schwarz   black	in einer Achse   in one axis	30
TINY BORD DTO-B/G	<b>37166</b>	5905339371669	max 10	schwarz/ gold   black/gold	in einer Achse   in one axis	30
TINY BORD DTO-W	<b>37167</b>	5905339371676	max 10	weiß   white	in einer Achse   in one axis	30
TINY BORD DTO-W/G	<b>37168</b>	5905339371683	max 10	weiß/ gold   white/ gold	in einer Achse   in one axis	30

<b>[V]</b> 12 AC; 12 DC; 220-240 AC						

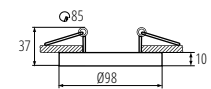

TINY BORD DTO

# Kanlux AGEO

EINBAU-DOWNLIGHT

► RING FOR SPOTLIGHT FITTINGS



AGEO DSO-W



AGEO DSO-B	<b>33165</b>	5905339331656	max 10	schwarz   black	in einer Achse   in one axis	20
AGEO DSO-W	<b>33166</b>	5905339331663	max 10	weiß   white	in einer Achse   in one axis	20

<b>[V]</b> 12 AC; 12 DC; 220-240 AC		 Gx5,3/GU10		 IP 20		 5+25
 Ø95	 0,5m	 MR16/PAR16				



AGEO DSO-B

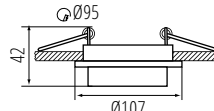

AGEO DSO



Mit dem Kanlux AGEO-Dekorringen können die Wohnräume originell eingerichtet werden. Das Leuchtmittel ist in einem verstellbaren, hervorstehenden Gehäuse, welches mittels eines Acryldiffusors für einen interessanten Lichteffect sorgt. Ein weiterer Vorzug der AGEO Leuchte ist der um 20 Grad verstellbare Winkel. Fassung und Leuchtmittel sind nicht im Set erhalten – Sie können selber bestimmen, ob Sie das Leuchtmittel mit Gx5,3 oder GU10 Fassung verwenden.

Dekorring ohne keramische Fassung  
Gehäusematerial: Aluminiumlegierung

Kanlux AGEO is an original decorative ring that will become a decoration for any room. The light source is completely hidden in an adjustable, extending from the ring shade, which provides an interesting light effect. Kanlux AGEO is the ability to adjust the direction of light in the range of 20 degrees. The decorative ring is sold without a lamp holder - you decide which light source to use (the Gx5.3 or GU10 cap).

Decorative ring without a ceramic frame  
Enclosure material: aluminum alloy

# Kanlux IMINES

EINBAU-DOWNLIGHT

► RING FOR SPOTLIGHT FITTINGS



IMINES DSO-W



IMINES DSO-W	<b>29031</b>	5905339290311	max 10	weiß matt   matte white	nicht verfügbar   none	
--------------	--------------	---------------	--------	-------------------------	------------------------	--

<b>[V]</b> 12 AC; 12 DC; 220-240 AC		 Gx5,3/GU10		 IP 20		 5+25
 Ø95	 0,5m	 MR16/PAR16				



Kanlux IMINES ist eine einzigartige Leuchte, die einen überraschenden Lichteffect hat - wenn Sie das Licht einschalten, erhalten Sie einen zusätzlichen, dekorativen Lichtring.

Dekorring ohne keramische Fassung  
Gehäusematerial: Aluminiumlegierung, Kunststoff

Kanlux IMINES is a unique fixture, which has a surprising light effect - when you turn on the light, you get an additional, decorative light ring.

Decorative ring without a ceramic frame  
Enclosure material: aluminum alloy, plastic

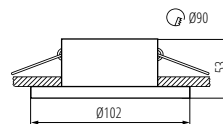

IMINES DSO

# Kanlux APRILA

EINBAU-DOWNLIGHT

► RING FOR SPOTLIGHT FITTINGS



APRILA DTO-W



APRILA DTO-W	<b>26738</b>	5905339267382	max 10	weiß matt   matte white	in einer Achse   in one axis	20
--------------	--------------	---------------	--------	-------------------------	------------------------------	----

<b>[V]</b> 12 AC; 12 DC; 220-240 AC		 Gx5,3/GU10		 IP 20		 5+25
 Ø90	 0,5m	 MR16/PAR16				

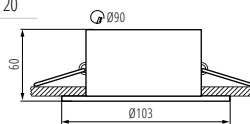

APRILA DTO



Kanlux APRILA sind stromlinienförmig und bieten die Möglichkeit, den Lichteinfallswinkel um 20 Grad zu variieren. Hier können JDR- oder MR-16-Leuchtmittel verwendet werden, dank denen für die Installation geeignete Leuchtmittel einsetzbar sind.

Dekorring ohne keramische Fassung  
Gehäusematerial: Aluminiumlegierung

Kanlux APRILA is a family of white decorative rings made of aluminium. Kanlux APRILA has a streamlined shape and can be adjusted in terms of the angle of light within the range of 20 degrees. The JDR or MR-16 frame can be used for the holders, which will allow us to use light sources adapted to a prepared installation.

Decorative ring without a ceramic frame  
Enclosure material: aluminum alloy

# Kanlux SEIDY

EINBAU-DOWNLIGHT ▶ CEILING-MOUNTED SPOTLIGHT FITTING



SEIDY CT-DT050-B/M



Kanlux SEIDY ist eine beliebte Familie von Deckenleuchten, bei der Sie zwischen Leuchten mit 1-er oder 2-er Leuchten wählen können. Dank der großen Auswahl an Farben und Texturen der Materialien, aus denen sie hergestellt werden, können wir sie zu einem idealen Beleuchtungssystem für Cafés, Hotelinterieurs, aber auch für häusliche Zwecke zusammensetzen.

Gehäusematerial: Aluminiumlegierung

Kanlux SEIDY is a popular family of holders in which you can choose from 1 to 4 light points. You will compose ideal lighting of coffee shops, hotel interiors and privacy interiors of them.

Enclosure material: aluminum alloy

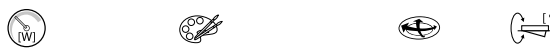

SEIDY CT-DT050-AL	<b>18280</b>	5905339182807	max 10	Aluminium gebürstet   brushed aluminium	in einer Achse   in one axis	30
SEIDY CT-DTL50-AL	<b>18281</b>	5905339182814	max 10	Aluminium gebürstet   brushed aluminium	in einer Achse   in one axis	30
SEIDY CT-DT050-B	<b>18288</b>	5905339182883	max 10	schwarz eloxiert   black anodised	in einer Achse   in one axis	30
SEIDY CT-DTL50-B	<b>18289</b>	5905339182890	max 10	schwarz eloxiert   black anodised	in einer Achse   in one axis	30
SEIDY CT-DTL50-W/M	<b>19454</b>	5905339194541	max 10	weiß matt   matte white	in einer Achse   in one axis	30
SEIDY CT-DTL250-W/M	<b>19455</b>	5905339194558	2 x max 10	weiß matt   matte white	in einer Achse   in one axis	30
SEIDY CT-DT050-W/M	<b>19456</b>	5905339194565	max 10	weiß matt   matte white	in einer Achse   in one axis	30
SEIDY CT-DT050-B/M	<b>19457</b>	5905339194572	max 10	schwarz matt   black matt	in einer Achse   in one axis	30
SEIDY CT-DTL50-B/M	<b>19458</b>	5905339194589	max 10	schwarz matt   black matt	in einer Achse   in one axis	30
SEIDY CT-DTL250-B/M	<b>19459</b>	5905339194596	2 x max 10	schwarz matt   black matt	in einer Achse   in one axis	30

12 AC; 12 DC	Gx5,3	III	4	IP 20	5+25	0,12
0,75	0,5m	MR-16				

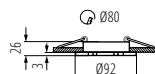

SEIDY CT-DT050

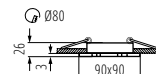

SEIDY CT-DTL50

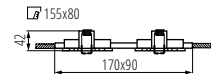

SEIDY CT-DTL250

**Kanlux**  
**SEIDY**

EINBAU-DOWNLIGHT ► CEILING-MOUNTED SPOTLIGHT FITTING



SEIDY CT-DT050-AL



SEIDY CT-DT050-B



SEIDY CT-DT050-W/M



SEIDY CT-DTL50-AL



SEIDY CT-DTL50-B



SEIDY CT-DTL50-W/M



SEIDY CT-DTL50-B/M



SEIDY CT-DTL250-B/M



SEIDY CT-DTL250-W/M





# SIMEN DSO

EINBAU-DOWNLIGHT ► RING FOR SPOTLIGHT FITTINGS



SIMEN DSO B/G



SIMEN DSO B/G	<b>29137</b>	5905339291370	max 10	schwarz/ gold   black/gold	nicht verfügbar   none
SIMEN DSO B/W	<b>29138</b>	5905339291387	max 10	schwarz/ weiß   black/white	nicht verfügbar   none
SIMEN DSO W/B	<b>29139</b>	5905339291394	max 10	weiß/ schwarz   white/ black	nicht verfügbar   none
SIMEN DSO W/G	<b>29140</b>	5905339291400	max 10	weiß/ gold   white/ gold	nicht verfügbar   none
SIMEN DSO G/W	<b>29142</b>	5905339291424	max 10	gold/ weiß   gold/ white	nicht verfügbar   none

<b>[V]</b> 12 AC; 12 DC; 220-240 AC						



SIMEN DSO B/W



SIMEN DSO W/G



SIMEN DSO G/W



SIMEN DSO W/B



Die Kanlux SIMEN DSO Leuchte besteht aus zwei Teilen: aus einem Ring und einem Körper. Wir bieten feste Farbsets in klassischem Schwarz-Weiß und Leuchten mit Silber- und Goldelementen an, die zu ihrer Einrichtung passen und dort zu dekorativen Elementen werden. Sie können auch Elemente der Kanlux SIMEN Leuchtensätze beliebig austauschen.

Dekorring ohne keramische Fassung  
Gehäusematerial: Aluminiumlegierung

Kanlux SIMEN DSO is a fixture which consists of two parts - ring, and body. Our range includes permanent colour sets in classic black and white, and fixtures with silver and gold elements, which will fit in with your interior, where they will become a visible decoration. You can also replace individual elements with other Kanlux SIMEN DSO fixture sets you already have.

Decorative ring without a ceramic frame  
Enclosure material: aluminum alloy

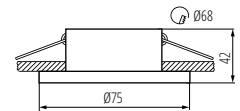

SIMEN DSO

# SIMEN DSL

EINBAU-DOWNLIGHT ► RING FOR SPOTLIGHT FITTINGS



SIMEN DSL SR/B/B



SIMEN DSL B/W/B	<b>29131</b>	5905339291318	max 10	schwarz/ weiß/ schwarz   black/ white/ black	nicht verfügbar   none
SIMEN DSL SR/B/B	<b>29132</b>	5905339291325	max 10	silber/ schwarz/ schwarz   silver/ black/ black	nicht verfügbar   none
SIMEN DSL B/G/B	<b>29134</b>	5905339291349	max 10	schwarz/ gold/ schwarz   black/ gold/ black	nicht verfügbar   none
SIMEN DSL W/G/W	<b>29135</b>	5905339291356	max 10	weiß/ gold/ weiß   white/ gold/ white	nicht verfügbar   none

<b>[V]</b> 12 AC; 12 DC; 220-240 AC						



SIMEN DSL B/G/B



SIMEN DSL W/G/W



SIMEN DSL B/W/B



Die Kanlux SIMEN DSL Leuchte besteht aus drei Teilen: aus einem Ring, einem Körper und einem Sockel. Wir bieten feste Farbsets in klassischem Schwarz-Weiß und Leuchten mit Silber- und Goldelementen an, die zu ihrer Einrichtung passen und dort zu dekorativen Elementen werden. Sie können auch Elemente der Kanlux SIMEN Leuchtensätze beliebig austauschen.

Dekorring ohne keramische Fassung  
Gehäusematerial: Aluminiumlegierung

Kanlux SIMEN DSL is a fixture which consists of three parts - ring, body and base. Our range includes prepared colour sets in classic black and white, or fixtures with silver and gold elements, which will fit in with your interior, where they will become a visible decoration. You can also replace individual elements with other Kanlux SIMEN DSL fixture sets you already have.

Decorative ring without a ceramic frame  
Enclosure material: aluminum alloy

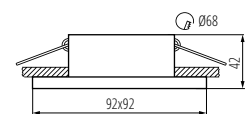

SIMEN DSL

# Kanlux ALOR

EINBAU-DOWNLIGHT ► RING FOR SPOTLIGHT FITTINGS



ALOR DSL-W

NEW



ALOR DSL-B



ALOR DTL-W

NEW



ALOR DTL-B



ALOR DSO-W

NEW



ALOR DSO-B



ALOR DTO-W

NEW



ALOR DTO-B

Kanlux ALOR ist eine Familie von Leuchten in den beliebtesten Farben: schwarz und weiß, mit einer matten Oberfläche. Die Leuchten werden nicht mit einer Keramikfassung geliefert. Es ist möglich, eine Fassung zu verwenden, die in einen GU10- oder Gx5.3-Schraubsockel passt, was die Verwendung von Lichtquellen ermöglicht, die an die vorbereitete Installation angepasst sind.

Dekorring ohne keramische Fassung  
Gehäusematerial: Stahl

Kanlux ALOR is a family of downlights in the most popular colors; black and white, with a matte finish. Downlight do not have a ceramic lamp holder in the set. We can use the lamp holder that will fit the GU10 or Gx5.3 base, which will allow us to use light sources adapted to the prepared installation.

Decorative ring without a ceramic frame  
Enclosure material: steel



NEW	ALOR DSL-W	26726	5905339267269	max 10	weiß matt   matte white	nicht verfügbar   none
	ALOR DSL-B	26727	5905339267276	max 10	schwarz matt   black matt	nicht verfügbar   none
NEW	ALOR DTL-W	26731	5905339267313	max 10	weiß matt   matte white	in einer Achse   in one axis 30
	ALOR DTL-B	26732	5905339267320	max 10	schwarz matt   black matt	in einer Achse   in one axis 30
NEW	ALOR DSO-W	26790	5905339267900	max 10	weiß matt   matte white	nicht verfügbar   none
	ALOR DSO-B	26791	5905339267917	max 10	schwarz matt   black matt	nicht verfügbar   none
NEW	ALOR DTO-W	26795	5905339267955	max 10	weiß matt   matte white	in einer Achse   in one axis 30
	ALOR DTO-B	26796	5905339267962	max 10	schwarz matt   black matt	in einer Achse   in one axis 30

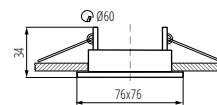

ALOR DSL

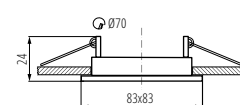

ALOR DTL

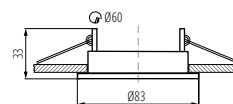

ALOR DSO

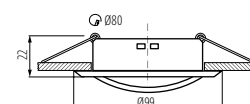

ALOR DTO

IV	12 AC; 12 DC; 220-240 AC	IP 20	MR16/PAR16	CE	UK CA
5+25	0,5m				

# Kanlux ELNIS S

EINBAU-DOWNLIGHT ► RING FOR SPOTLIGHT FITTINGS



ELNIS S W



ELNIS S W | **27800** | 5905339278005 | max 10 | weiß | white | nicht verfügbar | none

[V] 12 AC; 12 DC; 220-240 AC						
(mm) Ø70						

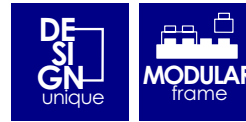

Die Leuchte Kanlux ELNIS besteht aus zwei Teilen. Es handelt sich um eine Kombination aus zwei verschiedenen Elementen: dem Körper (Hauptteil) und dem Gehäuse (Abstandsring), die ein perfekt abgestimmtes Ganzes bilden.

Dekorring ohne keramische Fassung  
Gehäusematerial: Aluminiumlegierung

The Kanlux ELNIS is a fixture which consists of two parts forming a whole. It is a combination of two separate elements: the body (the main part) and the casing (the spacer ring), forming a perfectly matched whole. ELNIS S is a fixture with a 10-mm-high casing. The Kanlux ELNIS is characterised by modern design and very-high quality of workmanship.

Decorative ring without a ceramic frame  
Enclosure material: aluminum alloy

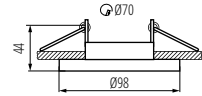

ELNIS S

# Kanlux ELNIS L

EINBAU-DOWNLIGHT ► RING FOR SPOTLIGHT FITTINGS



ELNIS L W/A



Die Leuchte Kanlux ELNIS besteht aus zwei Teilen. Es handelt sich um eine Kombination aus zwei verschiedenen Elementen: dem Körper (Hauptteil) und dem Gehäuse (Abstandsring), die ein perfekt abgestimmtes Ganzes bilden. ELNIS L ist eine 25 mm hohe Leuchte.

Dekorring ohne keramische Fassung  
Gehäusematerial: Aluminiumlegierung

The Kanlux ELNIS L is a fixture which consists of two parts forming a whole. It is a combination of two separate elements: the body (the main part) and the casing (the spacer ring), forming a perfectly matched whole. The ELNIS L is a fixture with a 25-mm-high casing. The Kanlux ELNIS L is characterised by modern design and very-high quality of workmanship.

Decorative ring without a ceramic frame  
Enclosure material: aluminum alloy



ELNIS L W



ELNIS L W/C



ELNIS L A/C



ELNIS L A



ELNIS L B/G



ELNIS L W	<b>27804</b>	5905339278043	max 10	weiß   white	nicht verfügbar   none
ELNIS L W/A	<b>27805</b>	5905339278050	max 10	weiß/ anthrazit   white/anthracite	nicht verfügbar   none
ELNIS L W/C	<b>27806</b>	5905339278067	max 10	weiß/ chrom   white/ chrome	nicht verfügbar   none
ELNIS L A/C	<b>27808</b>	5905339278081	max 10	anthrazit/ chrom   anthracite/ chrome	nicht verfügbar   none
ELNIS L A	<b>27809</b>	5905339278098	max 10	anthrazit   anthracite	nicht verfügbar   none
ELNIS L B/G	<b>27810</b>	5905339278104	max 10	schwarz/ gold   black/gold	nicht verfügbar   none

[V] 12 AC; 12 DC; 220-240 AC						
(mm) Ø70						

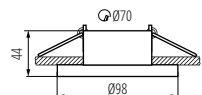

ELNIS L

# Kanlux DALLA

EINBAU-DOWNLIGHT ► CEILING-MOUNTED SPOTLIGHT FITTING



DALLA CT-DTL50-B



DALLA CT-DT050-W



DALLA CT-DTL50-W



DALLA CT-DT050-B



Kanlux DALLA ist eine sehr sorgfältig gefertigte Leuchte für den Innenbereich. Sie hat einen beweglichen Ring, so dass der Lichtstrahl individuell eingestellt werden kann. Ihre Formen und universellen Farben ermöglichen es, einen modernen, dezenten Eleganzeffekt zu erzielen.

Gehäusematerial: Aluminiumlegierung

Kanlux DALLA is a very carefully made holder for installation inside buildings. It has a movable ring, thanks to which you can adjust the light stream. Its shapes and universal colours allow achieving a modern, discrete effect of elegance.

Enclosure material: aluminum alloy



DALLA CT-DT050-W	<b>22430</b>	5905339224309	max 10	weiß   white	in einer Achse   in one axis	30
DALLA CT-DTL50-W	<b>22431</b>	5905339224316	max 10	weiß   white	in einer Achse   in one axis	30
DALLA CT-DT050-B	<b>22432</b>	5905339224323	max 10	schwarz   black	in einer Achse   in one axis	30
DALLA CT-DTL50-B	<b>22433</b>	5905339224330	max 10	schwarz   black	in einer Achse   in one axis	30

<b>[V]</b> 12 AC; 12 DC	<b>Gx5,3</b>	<b>III</b>	<b>IP</b> 20	<b>5+25</b>	<b>[mm]</b> Ø70	<b>[mm]</b> 0,12	<b>[mm]</b> 0,75	<b>[m]</b> 0,5m	<b>MR-16</b>	<b>CE</b>	<b>ERC</b>	<b>UK</b> <b>CA</b>
----------------------------	--------------	------------	-----------------	-------------	--------------------	---------------------	---------------------	--------------------	--------------	-----------	------------	------------------------

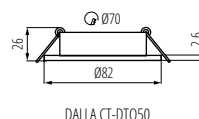

DALLA CT-DT050

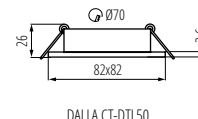

DALLA CT-DTL50

# Kanlux SOREN

EINBAU-DOWNLIGHT ► CEILING-MOUNTED SPOTLIGHT FITTING



SOREN O



SOREN L



Kanlux SOREN sind Glasleuchten, deren zusätzlicher Vorteil ein farbiger, dekorativer LED-Streifen ist, der den Glassockel der Leuchte beleuchtet.

Gehäusematerial: Glas

Kanlux SOREN are glass holders whose additional asset is the colourful, decorative LED strip lighting up the glass base of the holder.

Enclosure material: glass



SOREN O-SR VVV	<b>24410</b>	5905339244109	max 20	silber   silver	nicht verfügbar   none
SOREN O-BL	<b>24411</b>	5905339244116	max 20	silber   silver	nicht verfügbar   none
SOREN L-SR VVV	<b>24413</b>	5905339244130	max 20	silber   silver	nicht verfügbar   none
SOREN L-BL	<b>24414</b>	5905339244147	max 20	silber   silver	nicht verfügbar   none
SOREN O-SR CW	<b>24416</b>	5905339244161	max 20	silber   silver	nicht verfügbar   none
SOREN L-SR CW	<b>24417</b>	5905339244178	max 20	silber   silver	nicht verfügbar   none

<b>[V]</b> 220-240 AC	<b>[Hz]</b> 50	<b>[W]</b> LED 3,6	<b>PAR16</b>	<b>GU10</b>	<b>SMD</b>	<b>≥15000</b>	<b>20000</b>	<b>[h]</b>	<b>IP</b> 20	<b>5+25</b>	<b>[mm]</b> 0,75+2,5	<b>[m]</b> 0,5m	<b>CE</b>	<b>ERC</b>	<b>UK</b> <b>CA</b>
--------------------------	-------------------	-----------------------	--------------	-------------	------------	---------------	--------------	------------	-----------------	-------------	-------------------------	--------------------	-----------	------------	------------------------

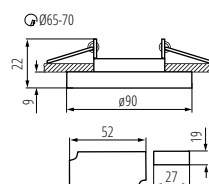

SOREN O

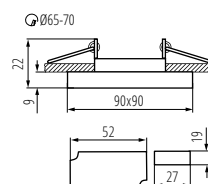

SOREN L

# Kanlux ELICEO

EINBAU-DOWNLIGHT ▶ RING FOR SPOTLIGHT FITTINGS



NEW

ELICEO DSO B



ELICEO DSO W/W



ELICEO DSO W/G



ELICEO DSO B/B



ELICEO-ST DSO W/W



ELICEO-ST DSO W/G



ELICEO-ST DSO B/B



ELICEO-ST DSO W

NEW



ELICEO-ST DSO YG

NEW



ELICEO-ST DSO GR

NEW



ELICEO-ST DSO PK

NEW



ELICEO-ST DSO BL

NEW



KANLUX ELICEO ist eine neue Spotleuchte in einem einzigartigen Design. Durch die Verwendung eines matten Acryldiffusors wird das Licht gestreut und das Leuchtmittel unsichtbar gemacht. Die Leuchte sieht aus wie eine miniatur-integrierte Aufbauleuchte.

Dekorring ohne keramische Fassung  
Gehäusematerial: Aluminiumlegierung

KANLUX ELICEO is a new holder for building in with a unique structure. The mat, acrylic lampshade diffuses light and makes the installed light source be invisible. The holder looks like a miniature integrated surface mounted luminaire.

Decorative ring without a ceramic frame  
Enclosure material: aluminum alloy



ELICEO DSO B/B	35280	5905339352804	max 10	schwarz   black	nicht verfügbar   none
ELICEO DSO W/W	35281	5905339352811	max 10	weiß   white	nicht verfügbar   none
ELICEO DSO W/G	35283	5905339352835	max 10	weiß/ gold   white/ gold	nicht verfügbar   none
ELICEO-ST DSO B/B	35284	5905339352842	max 10	schwarz   black	nicht verfügbar   none
ELICEO-ST DSO W/W	35285	5905339352859	max 10	weiß   white	nicht verfügbar   none
ELICEO-ST DSO W/G	35287	5905339352873	max 10	weiß/ gold   white/ gold	nicht verfügbar   none
ELICEO DSO W	35288	5905339352880	max 10	weiß   white	nicht verfügbar   none
ELICEO DSO B	35289	5905339352897	max 10	schwarz   black	nicht verfügbar   none
ELICEO DSO YG	35295	5905339352958	max 10	gold	nicht verfügbar   none
ELICEO DSO GR	35296	5905339352965	max 10	grün   green	nicht verfügbar   none
ELICEO DSO PK	35297	5905339352972	max 10	rosa   pink	nicht verfügbar   none
ELICEO DSO BL	35298	5905339352989	max 10	blau   blue	nicht verfügbar   none

NEW

 12 AC; 12 DC; 220-240 AC	 DALI	 DALI 2	 DALI 2+	 IP 20	 5+25
 Ø68	 0,5m	 MR16/PAR16	 CE	 UK CA	

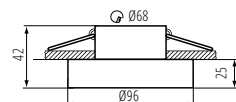

ELICEO DSO

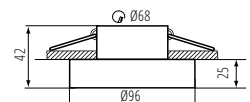

ELICEO-ST DSO

# Kanlux MORTA

EINBAU-DOWNLIGHT ► CEILING-MOUNTED SPOTLIGHT FITTING



MORTA CT-DLSL50-B



MORTA CT-DLSL50-SR



MORTA CT-DSO50-B



MORTA CT-DSO50-SR



Mit einer großen Auswahl an Kanlux MORTA-Leuchtenmodellen können Sie jeden Wohnraum sehr originell gestalten. Kanlux MORTA erfüllen die Erwartungen all derjenigen, die Wert auf hochwertige Produkte legen, die sich durch attraktives und originelles Design auszeichnen.

Gehäusematerial: Glas

A wide range of the Kanlux MORTA holder models will allow making very original arrangements in each house. Kanlux MORTA meet expectations of everyone that highly values products of high quality, characterized by attractive and original design.

Enclosure material: glass



MORTA CT-DLSL50-B	18510	5905339185105	max 10	schwarz   black	nicht verfügbar   none
MORTA CT-DLSL50-SR	18512	5905339185129	max 10	silber   silver	nicht verfügbar   none
MORTA CT-DSO50-B	19440	5905339194404	max 10	schwarz   black	nicht verfügbar   none
MORTA CT-DSO50-SR	19442	5905339194428	max 10	silber   silver	nicht verfügbar   none

12 AC; 12 DC	Gx5,3	IP 20	5+25	0,12
0,75	0,5m	MR-16	CE	EAC

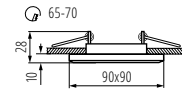

MORTA CT-DLSL50

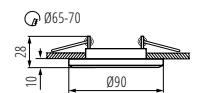

MORTA CT-DSO50

# Kanlux MORTA DT

EINBAU-DOWNLIGHT ► RING FOR SPOTLIGHT FITTINGS



MORTA CT-DTL50-B



MORTA CT-DTO50-SR



MORTA CT-DTO50-B



MORTA CT-DTL50-SR



Mit einer großen Auswahl an Kanlux MORTA-Leuchtenmodellen können Sie jeden Wohnraum sehr originell gestalten. Kanlux MORTA erfüllen die Erwartungen all derjenigen, die Wert auf hochwertige Produkte legen, die sich durch attraktives und originelles Design auszeichnen.

Dekorring ohne keramische Fassung

Gehäusematerial: Glas

A wide range of the Kanlux MORTA holder models will allow making very original arrangements in each house. Kanlux MORTA meet expectations of everyone that highly values products of high quality, characterized by attractive and original design.

Decorative ring without a ceramic frame

Enclosure material: glass



MORTA CT-DTO50-SR	26716	5905339267160	max 10	silber   silver	in einer Achse   in one axis	30
MORTA CT-DTO50-B	26717	5905339267177	max 10	schwarz   black	in einer Achse   in one axis	30
MORTA CT-DTL50-SR	26718	5905339267184	max 10	silber   silver	in einer Achse   in one axis	30
MORTA CT-DTL50-B	26719	5905339267191	max 10	schwarz   black	in einer Achse   in one axis	30

12 AC; 12 DC; 220-240 AC	Gx5,3/GU10	IP 20	5+25	Ø75-80
0,5m	MR16/PAR16	CE	EAC	UK CA

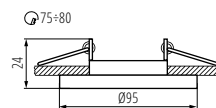

MORTA CT-DTO50-SR

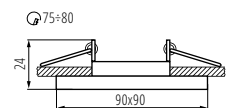

MORTA CT-DTL50

# MORTA OCT

EINBAU-DOWNLIGHT ► RING FOR SPOTLIGHT FITTINGS



MORTA OCT-SR



MORTA OCT-B



MORTA OCT-SR	<b>26714</b>	5905339267146	max 10	silber   silver	nicht verfügbar	none
MORTA OCT-B	<b>26715</b>	5905339267153	max 10	schwarz   black	nicht verfügbar	none

[V]					
12 AC; 12 DC; 220-240 AC	Gx5,3/GU10	MR16/PAR16	CE	IP 20	5+25
Ø60-65	0,5m				

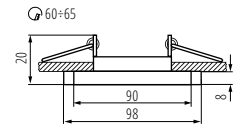

MORTA OCT

# MORTA B

EINBAU-DOWNLIGHT ► CEILING-MOUNTED SPOTLIGHT FITTING



MORTA B CT-DSL50-B



MORTA B CT-DSL50-SR



MORTA B CT-DSO50-B



MORTA B CT-DSO50-SR



MORTA B CT-DSL50-B	<b>22110</b>	5905339221100	max 10	schwarz   black	nicht verfügbar	none
MORTA B CT-DSL50-SR	<b>22112</b>	5905339221124	max 10	silber   silver	nicht verfügbar	none
MORTA B CT-DSO50-B	<b>22116</b>	5905339221162	max 10	schwarz   black	nicht verfügbar	none
MORTA B CT-DSO50-SR	<b>22117</b>	5905339221179	max 10	silber   silver	nicht verfügbar	none

[V]						
12 AC; 12 DC	Gx5,3	MR-16	CE	IP 20	5+25	Ø65-70
0,12	0,75	0,5m				

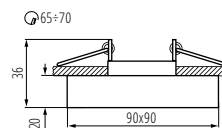

MORTA B CT-DSL50

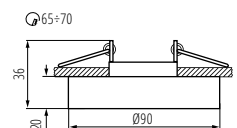

MORTA B CT-DSO50



Mit einer großen Auswahl an Kanlux MORTA-Leuchtenmodellen können Sie jeden Wohnraum sehr originell gestalten. Kanlux MORTA erfüllen die Erwartungen all derjenigen, die Wert auf hochwertige Produkte legen, die sich durch attraktives und originelles Design auszeichnen.

Dekorring ohne keramische Fassung  
Gehäusematerial: Glas

A wide range of the Kanlux MORTA holder models will allow making very original arrangements in each house. Kanlux MORTA meet expectations of everyone that highly values products of high quality, characterized by attractive and original design.

Decorative ring without a ceramic frame  
Enclosure material: glass



Mit einer großen Auswahl an Kanlux MORTA-Leuchtenmodellen können Sie jeden Wohnraum sehr originell gestalten. Kanlux MORTA erfüllen die Erwartungen all derjenigen, die Wert auf hochwertige Produkte legen, die sich durch attraktives und originelles Design auszeichnen.

Gehäusematerial: Glas

A wide range of the Kanlux MORTA holder models will allow making very original arrangements in each house. Kanlux MORTA meet expectations of everyone that highly values products of high quality, characterized by attractive and original design.

Enclosure material: glass

# Kanlux IVRI

EINBAU-DOWNLIGHT ► RING FOR SPOTLIGHT FITTINGS



Kanlux IVRI ist ein Dekorring aus Aluminium. Kanlux IVRI ist ausdrucksstark in seiner Form und der Bereich der Leuchtrichtung des Leuchtmittels beträgt 30 Grad.

Dekorring ohne keramische Fassung  
Gehäusematerial: Aluminiumlegierung

Kanlux IVRI is a decorative ring made of aluminium. Kanlux IVRI is expressive in its shape and adjustment of the direction of light - light source comes to 30 degrees.

Decorative ring without a ceramic frame  
Enclosure material: aluminum alloy



IVRI DTO-W



IVRI DTO-W | **26736** | 5905339267368 | max 10 | weiß | white | in einer Achse | in one axis | 30

<b>IVRI</b>						
12 AC; 12 DC; 220-240 AC		Gx5.3/GU10		IP 20		5+25
Ø83	0,5m	MR16/PAR16				

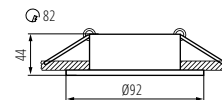

IVRI DTO

# Kanlux ARET

EINBAU-DOWNLIGHT ► RING FOR SPOTLIGHT FITTINGS



Die Serie der Kanlux ARET Leuchten besteht aus Dekorringen aus Aluminiumlegierung und Stahlblech. Diese Spotleuchten sind ohne Lampenfassung - Sie wählen selbst, ob Sie eine GU10- oder GX5.3-Lampenfassung einsetzen möchten. Dadurch können die Leuchtmittel an Installationen angepasst werden, die Sie in den vorhandenen Räumen haben. Kanlux ARET bewähren sich als Zusatzbeleuchtung sowohl in Privaträumen als auch in Bars und Restaurants, also überall dort, wo Sie eine interessante Raumeinrichtung hervorheben oder ein Akzent setzen möchten.

Dekorring ohne keramische Fassung  
Gehäusematerial: Aluminiumlegierung

A family of the Kanlux ARET holders are decorative rings made of aluminium alloy and steel metal sheet. These eyes are without a frame - you decide on your own whether to add the GU10 or GX5.3 frame to it. It allows adapting the light source to an installation available in a given room. Kanlux ARET works well as additional lighting both at homes, in bars and in restaurants, in places where you want to emphasize an interesting arrangement of a room or to display its fragment.

Decorative ring without a ceramic frame  
Enclosure material: aluminum alloy



ARET 1XMR16-W



ARET 2XMR16-W



ARET 1XMR16-W | **26720** | 5905339267207 | max 10 | weiß | white | in einer Achse | in one axis | 20  
ARET 2XMR16-W | **26723** | 5905339267238 | 2 x max 10 | weiß | white | in einer Achse | in one axis | 20

<b>IVRI</b>						
12 AC; 12 DC; 220-240 AC		Gx5.3/GU10		IP 20		5+25
	0,5m	MR16/PAR16				

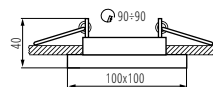

ARET 1XMR16

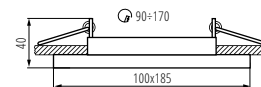

ARET 2XMR16



# ALREN R

EINBAU-DOWNLIGHT ► RING FOR SPOTLIGHT FITTINGS



ALREN R DTL-W



ALREN R DTL-B



ALREN R DTL-B	26757	5905339267573	max 10	schwarz   black	in zwei Achsen   in two axes	60°/60
ALREN R DTL-W	26758	5905339267580	max 10	weiß   white	in zwei Achsen   in two axes	60°/60

[V] 12 AC; 12 DC; 220-240 AC							
60°	80x80 (mm)	0,5m			CE	UK CA	

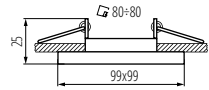

ALREN R DTL

# Kanlux ALREN

EINBAU-DOWNLIGHT ► RING FOR SPOTLIGHT FITTINGS



ALREN DTL-W



ALREN DTL-B



ALREN DTL-C-M

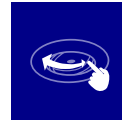

ALREN DTL-W	26753	5905339267535	max 35	weiß matt   matte white	in einer Achse   in one axis	15
ALREN DTL-B	26754	5905339267542	max 35	schwarz matt   black matt	in einer Achse   in one axis	15
ALREN DTL-C-M	26756	5905339267566	max 35	Chrom matt   chrome matte	in einer Achse   in one axis	15

[V] 12 AC; 12 DC; 220-240 AC							
83x83 (mm)	0,5m			CE	UK CA		

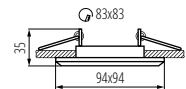

ALREN DTL



Die Zierringe Kanlux ALREN R haben eine interessante, auf dem Markt einzigartige Form - ein Gehäuse mit abgerundeten Ecken. Die Möglichkeit der Vertikalrotation um 60 Grad ist ein unbestreitbarer Vorzug. Kanlux ALREN R werden ohne Leuchtmittel angeboten.

Dekorring ohne keramische Fassung

Gehäusematerial: Aluminiumlegierung

Kanlux ALREN R decorative rings have an interesting shape of fixtures never before seen on the market - eyelets with rounded corners. The possibility of 60-degree adjustment in two planes is an unquestionable advantage. The Kanlux ALREN R is supplied without a socket.

Decorative ring without a ceramic frame

Enclosure material: aluminum alloy

Die Kanlux ALREN Dekorringe werden ohne Lampenfassung angeboten - Sie wählen selbst, ob Sie eine GU10- oder GX5.3-Lampenfassung einsetzen möchten. Die Deckeneinbauleuchten eignen sich hervorragend als Zusatzbeleuchtung in Häusern, Bars und Restaurants, also überall dort, wo Sie eine interessante Raumeinrichtung hervorheben oder ein Akzent setzen möchten.

Dekorring ohne keramische Fassung

Gehäusematerial: Aluminiumlegierung

The Kanlux ALREN decorative rings are offered without a frame - you decide on your own whether to add the GU10 or GX5.3 frame to it. The holders for building in a ceiling work well as additional lighting at homes, in bars and in restaurants, in places where you want to emphasize an arrangement of a room or to display its fragment.

Decorative ring without a ceramic frame

Enclosure material: aluminum alloy

# Kanlux COLIE

EINBAU-DOWNLIGHT ► RING FOR SPOTLIGHT FITTINGS



COLIE DTO-G



COLIE DTO-W



COLIE DTO-B



COLIE DTO-GR



Mit den Kanlux COLIE-Dekorringen können die Wohnräume originell eingerichtet werden. Sie zeichnen sich durch ein elegantes und originelles Design aus und sorgen gleichzeitig für eine diskrete Lichtverteilung. Die COLIE-Serie ist für die Deckenmontage vorgesehen. Sie bewähren sich als Zusatzbeleuchtung sowohl in Privathäusern als auch in Bars und Restaurants, also überall dort, wo wir eine interessante Raumeinrichtung hervorheben möchten.

Dekorring ohne keramische Fassung  
Gehäusematerial: Aluminiumlegierung

The Kanlux COLIE decorative rings will allow making very original arrangements in each house. They are characterized by elegant and original design ensuring, at the same time, discrete distribution of light. The COLIE series is intended for building in a ceiling. They work well as additional lighting both at homes, in bars and in restaurants, in places where you want to emphasize an interesting arrangement of a room.

Decorative ring without a ceramic frame  
Enclosure material: aluminum alloy



COLIE DTO-W	<b>26740</b>	5905339267405	max 10	weiß matt   matte white	in einer Achse   in one axis	15
COLIE DTO-G	<b>26741</b>	5905339267412	max 10	gold eloxiert   gold anodised	in einer Achse   in one axis	15
COLIE DTO-B	<b>26743</b>	5905339267436	max 10	schwarz matt   black matt	in einer Achse   in one axis	15
COLIE DTO-GR	<b>26744</b>	5905339267443	max 10	grau   grey	in einer Achse   in one axis	15

12 AC; 12 DC; 220-240 AC	Gx5,3/GU10	IP 20	5+25			
Ø75	0,5m	MR16/PAR16				

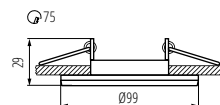

COLIE DTO

# Kanlux NESTA

EINBAU-DOWNLIGHT ► RING FOR SPOTLIGHT FITTINGS



NESTA DSL-C



NESTA DSL-C/M



NESTA DTL-C



NESTA DTL-C/M

Die Kanlux NESTA-Spotleuchten sind in zwei Varianten erhältlich: mit einem beweglichen Ring, dank dem die Leuchtrichtung individuell eingestellt werden kann, sowie mit einem unbeweglichen Ring. Die für die Deckenmontage vorgesehenen Leuchten eignen sich hervorragend als Zusatzbeleuchtung, sowohl für Wohnräume als auch für Cafés und Restaurants - überall dort, wo Sie interessante Innenraumgestaltung hervorheben möchten. In Gruppen installiert können diese Leuchten auch erfolgreich als Hauptbeleuchtung eingesetzt werden.

Dekorring ohne keramische Fassung  
Gehäusematerial: Aluminiumlegierung

The Kanlux NESTA eyes are available in a version with a movable ring, allowing to direct light into a given side and with an immovable ring. The holders intended for building in a ceiling work well as additional lighting both at homes, in coffee shops and in restaurants, in places where you want to emphasize an interesting arrangement of a room. These holders combined in a group can also successfully perform the function of main light.

Decorative ring without a ceramic frame  
Enclosure material: aluminum alloy



NESTA DSL-C	<b>26747</b>	5905339267474	max 10	chrom   chrome	nicht verfügbar   none	
NESTA DSL-C/M	<b>26748</b>	5905339267481	max 10	Chrom matt   chrome matte	nicht verfügbar   none	
NESTA DTL-C	<b>26751</b>	5905339267511	max 10	chrom   chrome	in einer Achse   in one axis	30
NESTA DTL-C/M	<b>26752</b>	5905339267528	max 10	Chrom matt   chrome matte	in einer Achse   in one axis	30

12 AC; 12 DC; 220-240 AC	Gx5,3/GU10	IP 20	5+25			
Ø75	0,5m	MR16/PAR16				

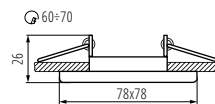

NESTA DSL

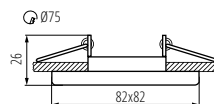

NESTA DTL

# Kanlux EVIT

EINBAU-DOWNLIGHT ▶ CEILING-MOUNTED SPOTLIGHT FITTING



EVIT CT-DTL50



EVIT CT-DTO50



EVIT CT-DTL50-AL	<b>18560</b>	5905339185600	max 10	Aluminium   aluminium	in einer Achse   in one axis	30
EVIT CT-DTO50-AL	<b>18561</b>	5905339185617	max 10	Aluminium   aluminium	in einer Achse   in one axis	30

				<b>IP 20</b>				
12 AC; 12 DC	Gx5,3	III		20		5+25	Ø70-75	
0,12	0,75	0,5m		MR-16				

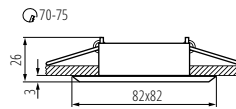

EVIT CT-DTL50

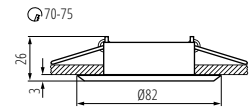

EVIT CT-DTO50

# Kanlux GWEN

EINBAU-DOWNLIGHT ▶ CEILING-MOUNTED SPOTLIGHT FITTING



GWEN CT-DTO50



GWEN CT-DTL50



GWEN CT-DTL50-B	<b>18530</b>	5905339185303	max 10	schwarz eloxiert   black anodised	in einer Achse   in one axis	30
GWEN CT-DTO50-B	<b>18531</b>	5905339185310	max 10	schwarz eloxiert   black anodised	in einer Achse   in one axis	30

				<b>IP 20</b>				
12 AC; 12 DC	Gx5,3	III		20		5+25	Ø70-75	
0,12	0,75	0,5m		MR-16				

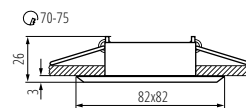

GWEN CT-DTL50

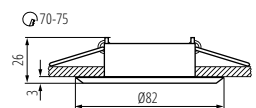

GWEN CT-DTO50

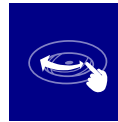

Kanlux EVIT ist eine Spotleuchte aus Aluminium mit der Möglichkeit, die Leuchtrichtung anzupassen. Kanlux EVIT ist eine klassische Spotleuchte ohne Verzierungen.

Gehäusematerial: Aluminiumlegierung

Kanlux EVIT is a spot-beam holder made of aluminium. It has a possibility of adjusting the direction of light. Kanlux EVIT is a classic eye without ornaments.

Enclosure material: aluminum alloy



Kanlux GWEN ist eine Einbauleuchte, dass sich perfekt in elegante, dezente Innenräume integriert. Gebürstetes Aluminium in Schwarz verleiht dem beleuchteten Innenraum einen Hauch von Glamour.

Gehäusematerial: Aluminiumlegierung

Kanlux GWEN is an eye which perfectly fits into elegant, discreet interiors. Brushed aluminium in black colour will add stylishness to lighted interior.

Enclosure material: aluminum alloy

# Kanlux LUTO

EINBAU-DOWNLIGHT ► CEILING-MOUNTED SPOTLIGHT FITTING



LUTO CTX-DS02B-W



LUTO CTX-DS02B-C/M



LUTO CTX-DS02B-AB



LUTO CTX-DT02B-W



LUTO CTX-DT02B-C

Kanlux LUTO sind klassische Spotleuchten in gedämpften Farben. Weiß, patiniertes Messing oder mattes Chrom verleihen nicht nur Ihrem Zuhause, sondern auch Hotels und Cafés dezenten Charme.

Gehäusematerial: Aluminiumlegierung

Kanlux LUTO is a line of classic eyes in discreet colours. The white, patina brass or mat chromium will discreetly add charm to a home space as well as to hotels and coffee shops.

Enclosure material: aluminum alloy



LUTO CTX-DS02B-W	<b>02580</b>	5905339025807	max 10	weiß   white	nicht verfügbar   none
LUTO CTX-DS02B-C/M	<b>02583</b>	5905339025838	max 10	Chrom matt   chrome matte	nicht verfügbar   none
LUTO CTX-DS02B-AB	<b>02584</b>	5905339025845	max 10	mattes Messing   matt brass	nicht verfügbar   none
LUTO CTX-DT02B-W	<b>02590</b>	5905339025906	max 10	weiß   white	in einer Achse   in one axis 15
LUTO CTX-DT02B-C	<b>02591</b>	5905339025913	max 10	chrom   chrome	in einer Achse   in one axis 15

<b>[V]</b> 12 AC; 12 DC	Gx5,3	III	IP 20	5+25	0,12
0,75	0,5m	MR-16	CE	EAC	UK CA

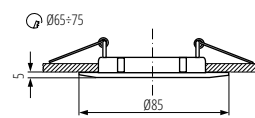

LUTO CTX-DS02B

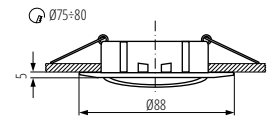

LUTO CTX-DT02B

# Kanlux NAVI

EINBAU-DOWNLIGHT ► CEILING-MOUNTED SPOTLIGHT FITTING



NAVI CTX-DT10-W



NAVI CTX-DT10-C/M



NAVI CTX-DS10-B



NAVI CTX-DT10-B

Kanlux NAVI ist eine Serie von einfachen, in ihrer Form verschiedenen Spotleuchten mit sehr breiten Einsatzmöglichkeiten.

Gehäusematerial: Aluminiumlegierung

Kanlux NAVI is a family of simple in their form, diverse spot-beam holders with very broad possibilities of use.

Enclosure material: aluminum alloy



NAVI CTX-DT10-W	<b>02550</b>	5905339025500	max 10	weiß   white	in einer Achse   in one axis 15
NAVI CTX-DT10-C/M	<b>02553</b>	5905339025531	max 10	Chrom matt   chrome matte	in einer Achse   in one axis 15
NAVI CTX-DS10-B	<b>25990</b>	5905339259905	max 10	schwarz matt   black matt	nicht verfügbar   none
NAVI CTX-DT10-B	<b>25991</b>	5905339259912	max 10	schwarz matt   black matt	in einer Achse   in one axis 15

<b>[V]</b> 12 AC; 12 DC	Gx5,3	III	IP 20	5+25	0,12
0,75	0,5m	MR-16	CE	EAC	UK CA

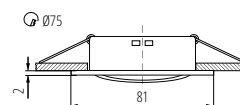

NAVI CTX-DT10

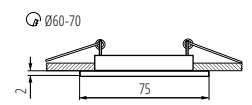

NAVI CTX-DS10

# Kanlux VIDI

EINBAU-DOWNLIGHT ► CEILING-MOUNTED SPOTLIGHT FITTING



VIDI CTC-5515-W



VIDI CTC-5514-C/M



VIDI CTC-5514-B



VIDI CTC-5514-W



VIDI CTC-5514-C



VIDI CTC-5515-C/M



VIDI CTC-5515-B

Kanlux VIDI ist eine Serie von einfachen und verschiedenen Spotleuchten. Wir können daraus unterschiedlichen Kompositionen zusammenstellen, wobei auch viele Farben dieser Aluminiumleuchten zur Auswahl stehen.

Gehäusematerial: Aluminiumlegierung

Kanlux VIDI is a family of simple in their form, diverse spot-beam holders. You can compose diverse lighting sets of them, choosing from among many colours of these aluminium holders.

Enclosure material: aluminum alloy



VIDI CTC-5515-W	<b>02780</b>	5905339027801	max 10	weiß   white	in einer Achse   in one axis	15
VIDI CTC-5515-C	<b>02781</b>	5905339027818	max 10	chrom   chrome	in einer Achse   in one axis	15
VIDI CTC-5515-C/M	<b>02783</b>	5905339027832	max 10	Chrom matt   chrome matte	in einer Achse   in one axis	15
VIDI CTC-5514-W	<b>02790</b>	5905339027900	max 10	weiß   white	nicht verfügbar   none	
VIDI CTC-5514-C	<b>02791</b>	5905339027917	max 10	chrom   chrome	nicht verfügbar   none	
VIDI CTC-5514-C/M	<b>02793</b>	5905339027931	max 10	Chrom matt   chrome matte	nicht verfügbar   none	
VIDI CTC-5514-B	<b>25995</b>	5905339259950	max 10	schwarz matt   black matt	nicht verfügbar   none	
VIDI CTC-5515-B	<b>25996</b>	5905339259967	max 10	schwarz matt   black matt	in einer Achse   in one axis	15

				<b>IP</b> 20				
				<b>CE</b>	<b>ERC</b>	<b>UK</b> <b>CA</b>		

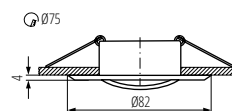

VIDI CTC-5515

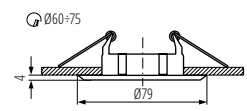

VIDI CTC-5514

# Kanlux RADAN

EINBAU-DOWNLIGHT

► CEILING-MOUNTED SPOTLIGHT FITTING



RADAN CT-DT050



RADAN CT-DS050

Kanlux Radan sind einfache Spotleuchten, die jeden Raum erhellen. Sie wählen das Leuchtmittel, sowie die Version der Leuchte - schwenkbar oder starr.

Gehäusematerial: Aluminiumlegierung

Kanlux RADAN are simple eyes which will light up each room. You can choose a source of light and a version of the holder on your own - with adjustment or immovable.

Enclosure material: aluminum alloy



RADAN CT-DT050	<b>07360</b>	5905339073600	max 10	Aluminium   aluminium	in einer Achse   in one axis	30
RADAN CT-DS050	<b>07362</b>	5905339073624	max 10	Aluminium   aluminium	nicht verfügbar   none	

<b>[V]</b> 12 AC; 12 DC	<b>Gx5,3</b>	<b>III</b>	<b>IP</b> 20	<b>5+25</b>	<b>0,12</b>
<b>0,75</b>	<b>0,5m</b>	<b>MR-16</b>	<b>CE</b>	<b>ERC</b>	<b>UK CA</b>

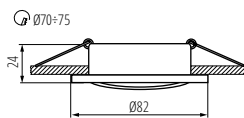

RADAN CT-DT0

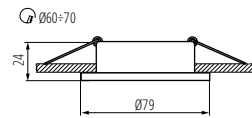

RADAN CT-DS0

# Kanlux TESON

EINBAU-DOWNLIGHT

► CEILING-MOUNTED SPOTLIGHT FITTING



TESON AL-DL50



TESON AL-DTL50



TESON AL-DS050

Kanlux TESON sind einfache Spotleuchten, die jeden Raum erhellen. Sie wählen das Leuchtmittel, sowie die Version der Leuchte - schwenkbar oder starr.

Gehäusematerial: Aluminiumlegierung

Kanlux TESON are simple eyes which will light up each room. You can choose a source of light and a version of the holder on your own - with adjustment or immovable.

Enclosure material: aluminum alloy



TESON AL-DTL50	<b>07371</b>	5905339073716	max 10	Aluminium   aluminium	in einer Achse   in one axis	30
TESON AL-DS050	<b>07372</b>	5905339073723	max 10	Aluminium   aluminium	nicht verfügbar   none	
TESON AL-DL50	<b>07373</b>	5905339073730	max 10	Aluminium   aluminium	nicht verfügbar   none	

<b>[V]</b> 220-240 AC	<b>[Hz]</b> 50	<b>GU10</b>	<b>IP</b> 20	<b>5+25</b>	<b>0,12</b>
<b>0,75+2,5</b>	<b>0,5m</b>	<b>PAR16</b>	<b>CE</b>	<b>ERC</b>	<b>UK CA</b>

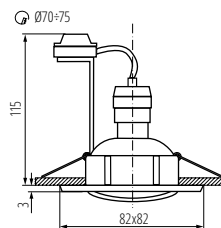

TESON AL-DTL

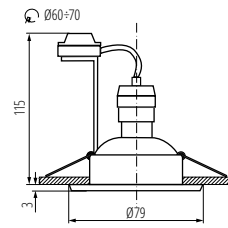

TESON AL-DSO

# Kanlux HORN

EINBAU-DOWNLIGHT

► CEILING-MOUNTED SPOTLIGHT FITTING



HORN CTC-3114

Die Familie der beliebten Kanlux HORN Leuchten bietet eine breite Palette von Modellen, von klassischen bis zu gewagten Farbkombinationen. Jeder kann ein Modell wählen, das perfekt zu seiner Einrichtung passt.

Gehäusematerial: Stahl

The popular Kanlux HORN mesh series is a cross-section of models; from classic to bold color combinations. Everyone can choose a model that is perfectly suited to their interior.

Enclosure material: steel



HORN CTC-3114-GM/N	<b>02824</b>	5905339028242	max 10	grafitgrau/ nickel   graphite/ nickel	nicht verfügbar   none	
--------------------	--------------	---------------	--------	---------------------------------------	------------------------	--

<b>[V]</b> 12 AC; 12 DC	<b>Gx5,3</b>	<b>III</b>	<b>IP</b> 20	<b>5+25</b>	<b>0,12</b>
<b>0,75</b>	<b>0,5m</b>	<b>MR-16</b>	<b>CE</b>	<b>ERC</b>	<b>UK CA</b>

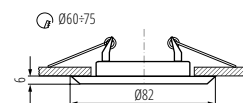

HORN CTC-3114

# ARGUS II

EINBAU-DOWNLIGHT ▶ RING FOR SPOTLIGHT FITTINGS



ARGUS II CT-2115-BR/M

Kanlux ARGUS II sind Zierringe, die eine Nachahmung der beliebten Kanlux ARGUS sind. Dank der Vielfalt an Formen und Farben findet jeder Liebhaber von Klassikern etwas für sich. Wir können eine Fassung verwenden, die zu einem GU10- oder Gx5.3-Stiel passt, was die Verwendung von Lichtquellen ermöglicht, die auf die vorbereitete Installation zugeschnitten sind.

Gehäusematerial: Stahl

Kanlux ARGUS II are decorative rings that reproduce the popular Kanlux ARGUS eyes. The variety of shapes and colors means that every classic lover will find something for themselves. We can use a lampholder that will fit a GU10 or Gx5.3 base, which allows the use of light sources tailored to the prepared installation.

Decorative ring without a ceramic frame

Enclosure material: steel



ARGUS II CT-2114-AN	<b>37150</b>	5905339371508	max 10	Kupfer, matt   matte copper	nicht verfügbar   none
ARGUS II CT-2114-BR/M	<b>37151</b>	5905339371515	max 10	mattes Messing   matt brass	nicht verfügbar   none
ARGUS II CT-2114-C	<b>37152</b>	5905339371522	max 10	chrom   chrome	nicht verfügbar   none
ARGUS II CT-2114-C/M	<b>37153</b>	5905339371539	max 10	Chrom matt   chrome matte	nicht verfügbar   none
ARGUS II CT-2114-G	<b>37154</b>	5905339371546	max 10	gold	nicht verfügbar   none
ARGUS II CT-2114-GM	<b>37155</b>	5905339371553	max 10	graphit   graphite	nicht verfügbar   none
ARGUS II CT-2114-W	<b>37156</b>	5905339371560	max 10	weiß   white	nicht verfügbar   none
ARGUS II CT-2115-AN	<b>37157</b>	5905339371577	max 10	Kupfer, matt   matte copper	in einer Achse   in one axis 15
ARGUS II CT-2115-BR/M	<b>37158</b>	5905339371584	max 10	mattes Messing   matt brass	in einer Achse   in one axis 15
ARGUS II CT-2115-C	<b>37159</b>	5905339371591	max 10	chrom   chrome	in einer Achse   in one axis 15
ARGUS II CT-2115-C/M	<b>37160</b>	5905339371607	max 10	Chrom matt   chrome matte	in einer Achse   in one axis 15
ARGUS II CT-2115-G	<b>37161</b>	5905339371614	max 10	gold	in einer Achse   in one axis 15
ARGUS II CT-2115-GM	<b>37162</b>	5905339371621	max 10	graphit   graphite	in einer Achse   in one axis 15
ARGUS II CT-2115-W	<b>37163</b>	5905339371638	max 10	weiß   white	in einer Achse   in one axis 15

<b>[V]</b>							
<b>12 AC; 12 DC; 220-240 AC</b>							
 5+25							

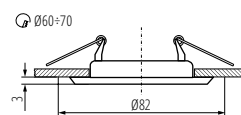

ARGUS II CT-2114

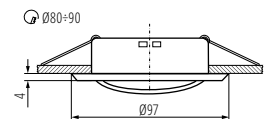

ARGUS II CT-2115

**Kanlux**

# ARGUS II

EINBAU-DOWNLIGHT ► RING FOR SPOTLIGHT FITTINGS



ARGUS II CT-2114-C



ARGUS II CT-2114-W



ARGUS II CT-2114-C/M



ARGUS II CT-2114-AN



ARGUS II CT-2114-BR/M



ARGUS II CT-2114-GM



ARGUS II CT-2115-C



ARGUS II CT-2115-W



ARGUS II CT-2115-C/M



ARGUS II CT-2115-AN



ARGUS II CT-2115-BR/M



ARGUS II CT-2115-GM



ARGUS II CT-2115-G





# TRIBIS II

EINBAULEUCHTEN-SET INKLUSIVE LEUCHTMITTELL

▶ A SET OF RECESSED DOWNLIGHTS WITH A LIGHT SOURCE (INCLUDED)



TRIBIS II O B

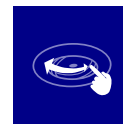

Kanlux TRIBIS II ist ein kompletter Beleuchtungsset bestehend aus: Deckenleuchten, Leuchtmitteln und Lampenfassungen BR-GU10. Sie können zwischen zwei Formen (quadratisch und rund) und mehreren Farbvarianten wählen. TRIBIS-Deckenleuchten sind in einer Version mit einem schwenkbaren Ring erhältlich, die es ermöglicht, das Licht in eine bestimmte Richtung zu lenken. Die TRIBIS II-Strahler von Kanlux sind für den Einbau in die Decke konzipiert und eignen sich perfekt als Haupt- oder Zusatzbeleuchtung. Sie können sie in einer Gruppe platzieren oder auf mehrere Orte verteilen.

Gehäusematerial: Stahl

Kanlux TRIBIS II is a complete set of 3 spots, which consists of: decorative rings, light sources and ceramic lamp holders with a bracket. We can choose between two shapes (square and round) and several color variants. Kanlux TRIBIS II spots can be angularly adjusted by 50°, so we can direct them in the desired direction. Kanlux TRIBIS II spotlights designed to be recessed into the ceiling, are perfect as main or additional lighting. You can put them in a group or split them among several places.

Enclosure material: steel



TRIBIS II L AB	<b>23843</b>	5905339238436	3 x max 10	patiniertes Messing   patinated brass	in einer Achse   in one axis	50
TRIBIS II L C	<b>23844</b>	5905339238443	3 x max 10	chrom   chrome	in einer Achse   in one axis	50
TRIBIS II L CVM	<b>23845</b>	5905339238450	3 x max 10	Chrom matt   chrome matte	in einer Achse   in one axis	50
TRIBIS II O AB	<b>23846</b>	5905339238467	3 x max 10	patiniertes Messing   patinated brass	in einer Achse   in one axis	50
TRIBIS II O C	<b>23847</b>	5905339238474	3 x max 10	chrom   chrome	in einer Achse   in one axis	50
TRIBIS II O CVM	<b>23848</b>	5905339238481	3 x max 10	Chrom matt   chrome matte	in einer Achse   in one axis	50
TRIBIS II L W	<b>23849</b>	5905339238498	3 x max 10	weiß   white	in einer Achse   in one axis	50
TRIBIS II L B	<b>23853</b>	5905339238535	3 x max 10	schwarz   black	in einer Achse   in one axis	50
TRIBIS II O W	<b>23854</b>	5905339238542	3 x max 10	weiß   white	in einer Achse   in one axis	50
TRIBIS II O B	<b>23855</b>	5905339238559	3 x max 10	schwarz   black	in einer Achse   in one axis	50

[V] 220-240 AC	[Hz] 50	GU10	IP 20	5+25	0,75+2,5	0,5m	PAR16 LED	SMD	4,9	400	120°	3000	80	≥15000
CE	EAC	UK CA												

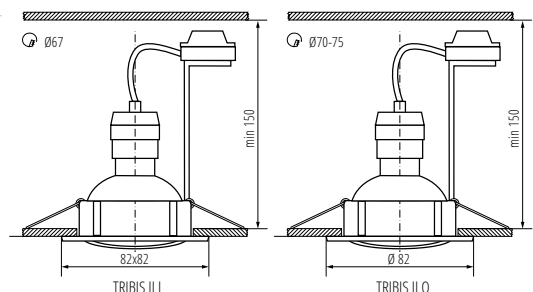

**Kanlux**

# TRIBIS II

EINBAULEUCHTEN-SET INKLUSIVE LEUCHTMITTELL ► A SET OF RECESSED DOWNLIGHTS WITH A LIGHT SOURCE (INCLUDED)



TRIBIS II L AB



TRIBIS II L C



TRIBIS II L C/M



TRIBIS II L W



TRIBIS II L B



TRIBIS II O C/M



TRIBIS II O AB



TRIBIS II O C



TRIBIS II O W



# DROXY IP65

EINBAU-DOWNLIGHT ► RING FOR SPOTLIGHT FITTINGS



Kanlux DROXY IP65 ist eine Familie von Einbau-Downlight für Badezimmer und Räume mit erhöhter Feuchtigkeit (IP65/20). Die Familie besteht aus 2 Modellen in runden Formen. Sie zeichnen sich durch ihre dekorative, sehr glatte Oberfläche aus, die in Verbindung mit den matten Farben (weiß und schwarz) im Raum, in dem sie installiert werden, eine beispiellos elegante und zugleich diskrete Wirkung erzielt.

Dekorring ohne keramische Fassung  
Gehäusematerial: Aluminiumlegierung

Kanlux DROXY IP65 is a family of decorative spotlights dedicated to bathrooms and rooms with high humidity (IP65 / 20). The ring family consists of 2 models of round housings. Their distinguishing feature is the decorative, exceptionally smooth surface, which, combined with matte colors (white and black), gives an unusually elegant, but discreet effect in the room where they are installed.

Decorative ring without a ceramic frame  
Enclosure material: aluminum alloy



DROXY IP65 DSO-W



DROXY IP65 DSO-B



DROXY IP65 DSO-W	<b>33125</b>	5905339331250	max 10	weiß   white	nicht verfügbar   none
DROXY IP65 DSO-B	<b>33126</b>	5905339331267	max 10	schwarz   black	nicht verfügbar   none

[V]				
12 AC; 12 DC; 220-240 AC	MR16/PAR16	IP 65/20	-10+35	
Ø68	0,5m	CE	UK CA	

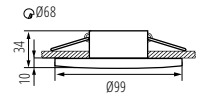

DROXY IP65 DSO

# FLINI IP44

EINBAU-DOWNLIGHT ► RING FOR SPOTLIGHT FITTINGS



Kanlux FLINI sind Deckeneinbauleuchten, die für Badezimmer und Räume mit erhöhter Luftfeuchtigkeit bestimmt sind (IP44). Kanlux FLINI sind in rund und eckig sowie in mattweiß und mattschwarz erhältlich. Die zwei universellen Farben ermöglichen es uns, diese Lampen an fast jede Einrichtung anzupassen. Kanlux FLINI ähnelt dank seiner Konstruktion einer kleinen Aufbau Lampe, was ihre Verwendung, unabhängig vom Stil unseres Badezimmers, zusätzlich unterstützt.

Dekorring ohne keramische Fassung  
Gehäusematerial: Aluminiumlegierung

Kanlux FLINI are ceiling luminaires dedicated for bathrooms and rooms with increased humidity. Thanks to their design, they are resistant to moisture (IP44). Kanlux FLINI are available in two shapes - round and square. You can choose between matt white or matt black. Two such universal colours will allow us to match these lamps to almost any interior .

Decorative ring without a ceramic frame  
Enclosure material: aluminum alloy



FLINI IP44 DSL-W



FLINI IP44 DSL-B



FLINI IP44 DSO-B



FLINI IP44 DSO-W



FLINI IP44 DSL-B	<b>33120</b>	5905339331205	max 10	schwarz   black	nicht verfügbar   none
FLINI IP44 DSL-W	<b>33121</b>	5905339331212	max 10	weiß   white	nicht verfügbar   none
FLINI IP44 DSO-B	<b>33122</b>	5905339331229	max 10	schwarz   black	nicht verfügbar   none
FLINI IP44 DSO-W	<b>33123</b>	5905339331236	max 10	weiß   white	nicht verfügbar   none

[V]			
12 AC; 12 DC; 220-240 AC	Gx5.3/GU10	IP 44/20	
Ø60	0,5m	CE	UK CA

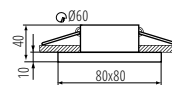

FLINI IP44 DSL

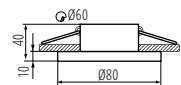

FLINI IP44 DSO

# Kanlux QULES

EINBAU-DOWNLIGHT

► CEILING-MOUNTED SPOTLIGHT FITTING



QULES AC O-W



QULES AC O-C/M



QULES AC O-B

**IP**  
**44/20**

Kanlux QULES-Deckenspotleuchten sind eine der beliebtesten Leuchten mit erhöhter Schutzart (IP). Sie eignen sich ideal für die Montage im Badezimmer oder in anderen Räumen mit hoher Luftfeuchtigkeit.

Gehäusematerial: Aluminiumlegierung

The Kanlux QULES ceiling eyes are one of the most popular holders with increased IP. They are ideal for mounting in a bathroom or in other places with increased humidity.

Enclosure material: aluminum alloy



QULES AC O-W	<b>26303</b>	5905339263032	max 10	weiß   white	nicht verfügbar   none
QULES AC O-C/M	<b>26304</b>	5905339263049	max 10	Chrom matt   chrome matte	nicht verfügbar   none
QULES AC O-B	<b>26306</b>	5905339263063	max 10	schwarz   black	nicht verfügbar   none

<b>[V]</b> 220-240 AC	<b>[Hz]</b> 50	<b>GU10</b>			<b>IP</b> 44/20		
			<b>PAR16</b>	<b>CE</b>	<b>ERAC</b>	<b>UK CA</b>	

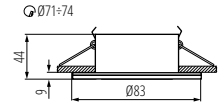

QULES AC O

# Kanlux MARIN

EINBAU-DOWNLIGHT ► CEILING-MOUNTED SPOTLIGHT FITTING



MARIN CT-S80-C



MARIN CT-S80-B



MARIN CT-S80-SN



MARIN CT-S80-AB



MARIN CT-S80-W

**IP**  
**44/20**

Kanlux MARIN sind kleine, dichte Deckenleuchten, die in Bereichen mit hoher Luftfeuchtigkeit eingesetzt werden können. Sie können diese Leuchten problemlos im Badezimmer über dem Spiegel, in der Küche oder in der Waschküche installieren.

Gehäusematerial: Stahl

Kanlux MARIN means small and tight ceiling holders to be used in places with increased humidity. They can easily be placed in a bathroom above a mirror, in a kitchen or in a laundry.

Enclosure material: steel



MARIN CT-S80-C	<b>04703</b>	5905339047038	max 10	chrom   chrome	nicht verfügbar   none
MARIN CT-S80-SN	<b>04704</b>	5905339047045	max 10	Nickel matt   nickel matte	nicht verfügbar   none
MARIN CT-S80-AB	<b>04710</b>	5905339047106	max 10	mattes Messing   matt brass	nicht verfügbar   none
MARIN CT-S80-W	<b>32500</b>	5905339325006	max 10	weiß   white	nicht verfügbar   none
MARIN CT-S80-B	<b>32501</b>	5905339325013	max 10	schwarz matt   black matt	nicht verfügbar   none

<b>[V]</b> 12 AC; 12 DC	<b>Gx5,3</b>			<b>IP</b> 44/20			
			<b>MR-16</b>	<b>CE</b>	<b>ERAC</b>	<b>UK CA</b>	

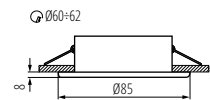

MARIN CT

# IMBER LED

EINBAU-DOWNLIGHT ▶ LED MIRROR LIGHT FITTING



IMBER LED

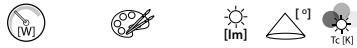

IMBER LED NW	<b>23520</b>	5905339235206	1	Aluminium   aluminium	40	105	4000
IMBER LED CW	<b>23521</b>	5905339235213	1	Aluminium   aluminium	40	105	6500
IMBER LED WW	<b>23522</b>	5905339235220	1	Aluminium   aluminium	40	105	3000

[V]	12 AC; 12 DC	≥20000	30000	Alipse ≤ 6x Mackdan	Ra 80	SMD	III	IP 65	House icon
Temperature	-20+50	Wiring	Ø27	0,1m	CE	ERL	UK	Recycling	

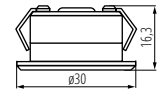

IMBER LED



Kanlux IMBER LED ist eine wasserdichte Einbauleuchte. Eine ihrer Stärken ist die niedrige Betriebstemperatur, dank derer sie ohne weiteres auch in Holz eingebaut werden kann. Das einzigartige Design der Leuchte mit einer gleichmäßigen Lichtverteilung und die hier eingesetzten LED's garantieren eine hohe Energieeffizienz. Die Kanlux IMBER LED-Leuchte ist eine großartige Idee, um Duschkabinen oder Dachverkleidungen außerhalb des Hauses zu beleuchten.

Gehäusematerial: Aluminiumlegierung  
Abdeckungsmaterial: Kunststoff

Kanlux IMBER LED is a waterproof holder intended for building in. Low temperature of work is one of its assets, thanks to which it can be easily mounted in wood as well. The unique structure of the holder means a regular emission of light and LED diodes used here guarantee high energy efficiency. The Kanlux IMBER LED holder is a perfect idea to highlight shower baths or outdoor soffits outside a house.

Enclosure material: aluminum alloy  
Lampshade material: plastic

# OYO

LED-LICHTPUNKT ▶ LED MIRROR LIGHTS



OYO SLED



Kanlux OYO LED sind punktförmige Lichtakzente, die als dekorative Beleuchtung eingesetzt werden. Kleine Lichtpunkte helfen Ihnen, dank der hohen Schutzart IP68 mutige Beleuchtungsprojekte auch in Saunen und Badezimmern umzusetzen.

OYO SLED-CW 5 Stück im Set  
Gehäusematerial: Metall, Kunststoff

Kanlux OYO LED are spot-beam light accents to be used as decorative lighting. The small light points will help us to implement brave lighting projects also in saunas and bathrooms thanks to high tightness - IP68.

OYO SLED-CW, 5 pcs included  
Enclosure material: Metal, plastic

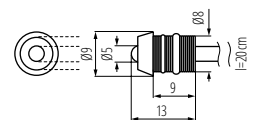

OYO SLED

NICHT VERFÜGBAR FÜR DEN DEUTSCHEN MARKT



OYO SLED-CW	<b>08121</b>	5905339081216	0,22	chrom   chrome	5	15	6500
-------------	--------------	---------------	------	----------------	---	----	------

[V]	12 DC	30000	III	IP 68	House icon	Wiring	Ø8	0,1m	W 23	CE	ERL	UK	Recycling
-----	-------	-------	-----	----------	------------	--------	----	------	------	----	-----	----	-----------

# ASTIM LED IP44

LED-MÖBELLEUCHE ▶ LINEAR LED FURNITURE LIGHT



ASTIM IP44 8W-NW-B



ASTIM IP44 8W-NW-C



ASTIM IP44 8W-NW-W



ASTIM IP44 12W-NW-B



ASTIM IP44 12W-NW-W



ASTIM IP44 12W-NW-C



ASTIM IP44 8W-NW-B	<b>34930</b>	5905339349309	8	schwarz   black	590	4000
ASTIM IP44 8W-NW-W	<b>34931</b>	5905339349316	8	weiß   white	690	4000
ASTIM IP44 8W-NW-C	<b>34932</b>	5905339349323	8	chrom   chrome	660	4000
ASTIM IP44 12W-NW-B	<b>34933</b>	5905339349330	12	schwarz   black	910	4000
ASTIM IP44 12W-NW-W	<b>34934</b>	5905339349347	12	weiß   white	1070	4000
ASTIM IP44 12W-NW-C	<b>34935</b>	5905339349354	12	chrom   chrome	1010	4000

[V] 220-240 AC	[Hz] 50	[mm] 0,75+1,5	[h] ≥15000	[h] 25000	[lm] ≤6x/Max/dam	Ra 80	SMD
[IP] 44	[°C] 5+30	[m] 0,1m	[°] X120/Y105	[m] 0,1m	[°] X120/Y105	[m] 0,1m	[m] 0,1m
[CE]	[EAC]	[UK CA]	[RoHS]	[RECYCLE]	[RECYCLE]	[RECYCLE]	[RECYCLE]

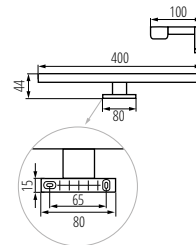

ASTIM IP44 8W

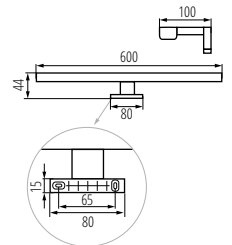

ASTIM IP44 12W

# ROLSO

LED-SPIEGELWANDLEUCHE IP44 ▶ WALL-MOUNTED LED LIGHT FITTING, IP44



ROLSO LED IP44 15W-NW



ROLSO LED IP44 15W-NW	<b>26700</b>	5905339267009	15	weiß/ chrom   white/ chrome	1470	4000
-----------------------	--------------	---------------	----	-----------------------------	------	------

[V] 220-240 AC	[Hz] 50	[mm] ≥15000	[h] 25000	[h] 25000	[lm] ≤6x/Max/dam	Ra 80	SMD	[IP] 44	[°C] 5+30	[m] 0,75+1,5	[m] 0,1m	[°] X120/Y105	[m] 0,1m
[CE]	[EAC]	[UK CA]	[RoHS]	[RECYCLE]	[RECYCLE]	[RECYCLE]	[RECYCLE]	[RECYCLE]	[RECYCLE]	[RECYCLE]	[RECYCLE]	[RECYCLE]	[RECYCLE]



Kanlux ASTIM ist eine Möbelleuchte mit erhöhter Dichtigkeit (IP44). Diese Leuchten zeichnen sich dadurch aus, dass sie auf den Rahmen eines Spiegels oder eines Schrankes eingebaut werden. Dank drei universeller Farben lassen sie sich an Bäder mit traditionellem oder modernem Design anpassen.

Gehäusematerial: Aluminiumlegierung  
Abdeckungs material: Kunststoff

Kanlux ASTIM is a bathroom luminaire with increased tightness (IP44). These luminaires are mounted to a mirror frame or cabinet. With three versatile colours, you can match them to bathrooms with traditional or modern decor.

Enclosure material: aluminum alloy  
Lampshade material: plastic



Kanlux ROLSO ist eine moderne LED-Heimleuchte, die hochwertiges Licht ausstrahlt. Ihr zusätzliches Plus ist ihr dezentes Design, das vor allem mit modernen Interieurs perfekt harmonisiert. Die Leuchte ist ideal als Badbeleuchtung, dank ihrer hohen IP-Schutzart (44) kann sie auch in Räumen mit erhöhter Luftfeuchtigkeit eingesetzt werden.

Gehäusematerial: Aluminiumlegierung  
Abdeckungs material: Kunststoff

Kanlux ROLSO is a modern LED home luminaire that emits high-quality light, and its additional advantage is its subtle design, which harmonizes perfectly with modern interiors. This fixture is perfect for bathroom lighting and, thanks to its high IP rating (44), it can be used in rooms with high humidity.

Enclosure material: aluminum alloy  
Lampshade material: plastic

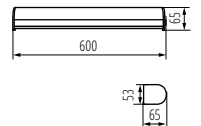

ROLSO LED IP44 15W-NW

# ASTEN LED IP44

LED-WANDLEUCHTE ▶ LED WALL MOUNTED FITTING



ASTEN LED IP44 8W-NW

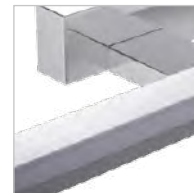

Kanlux ASTEN LED ist eine LED-Wandleuchte, die in Schlafzimmern, Umkleidekabinen, aber auch (dank IP 44) in Räumen mit hoher Luftfeuchtigkeit eingesetzt wird. Ohne weiteres können wir sie über dem Badezimmerspiegel montieren. Die Lampe verfügt über integrierte Lichtquellen auf Basis von SMD-LEDs, deren Lebensdauer mindestens 25.000 Stunden beträgt.

Gehäusematerial: Aluminiumlegierung  
Abdeckungsmaterial: Kunststoff

Kanlux ASTEN LED is a linear wall luminaire to be used in places with increased humidity (IP44). You can easily mount it above the bathroom mirror. The lamp has a built-in light source based on SMD LED diodes, which lifetime is at least 25,000 hours.

Enclosure material: aluminum alloy  
Lampshade material: plastic



ASTEN LED IP44 8W-NW	<b>26680</b>	5905339266804	8	chrom   chrome	660	4000
ASTEN LED IP44 12W-NW	<b>26681</b>	5905339266811	12	chrom   chrome	1010	4000
ASTEN LED IP44 15W-NW	<b>26682</b>	5905339266828	15	chrom   chrome	1340	4000
ASTEN IP44 8W-NW-B	<b>26683</b>	5905339266835	8	schwarz   black	590	4000
ASTEN IP44 12W-NW-B	<b>26684</b>	5905339266842	12	schwarz   black	910	4000
ASTEN IP44 15W-NW-B	<b>26685</b>	5905339266859	15	schwarz   black	1230	4000
ASTEN IP44 8W-NW-W	<b>26686</b>	5905339266866	8	weiß   white	690	4000
ASTEN IP44 12W-NW-W	<b>26687</b>	5905339266873	12	weiß   white	1070	4000
ASTEN IP44 15W-NW-W	<b>26688</b>	5905339266880	15	weiß   white	1450	4000

[V] 220-240 AC	[Hz] 50	[°] X120/Y105	[h] ≥15000	[h] 25000	[Ra] 80	[SMD]
[IP] 44	[°C] 5+30	[mm] 0,75÷1,5	[CE]	[EAC]	[UKCA]	[RoHS]

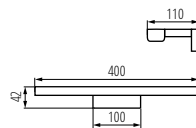

ASTEN LED IP44 8W

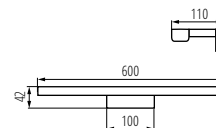

ASTEN LED IP44 12W

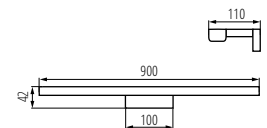

ASTEN LED IP44 15W

**Kanlux**

# ASTEN LED IP44

LED-WANDLEUCHE ▶ LED WALL MOUNTED FITTING



ASTEN LED IP44 8W-NW



ASTEN LED IP44 12W-NW



ASTEN LED IP44 15W-NW



ASTEN IP44 8W-NW-B



ASTEN IP44 12W-NW-B



ASTEN IP44 15W-NW-B



ASTEN IP44 8W-NW-W



ASTEN IP44 12W-NW-W



ASTEN IP44 15W-NW-W





# AKVO IP44 S

LED-WANDLEUCHTE ▶ LED WALL MOUNTED FITTING

NEW



AKVO IP44 23W

AKVO IP44 20W

AKVO IP44 15W



AKVO IP44 15W-NW-W S

AKVO IP44 15W-NW-B S

AKVO IP44 15W-NW-C S



Kanlux AKVO IP44 S sind Wand- und Deckenleuchten in drei Farben: Weiß, Chrom und Schwarz. Die Leuchte ist in 3 Längen und drei Leistungen erhältlich: 60 cm – 15 W, 80 cm – 20 W und 100 cm – 23 W. Kanlux AKVO S-Leuchten können vertikal und horizontal, an der Wand oder an der Decke montiert werden, wodurch nahezu unbegrenzte Anordnungsmöglichkeiten entstehen. Darüber hinaus verfügen diese Lampen über eine erhöhte Feuchtigkeitsbeständigkeit IP44, sodass Sie sie sicher im Badezimmer oder in der Waschküche montieren können. Kanlux AKVO IP44 S-Lampen eignen sich perfekt für die Beleuchtung von Räumen wie Badezimmer, Waschküche, Hauswirtschaftsraum, Flur oder Garderobe. Kanlux AKVO IP 44 S sind mit einem dezenten Schalter ausgestattet, der sich im Gehäuse der Leuchte befindet. Diese Lampen haben eine hohe Lichtausbeute von über 100 Lumen pro Watt und helfen Ihnen so, Strom zu sparen.

Gehäusematerial: Aluminiumlegierung

Abdeckungs material: Kunststoff

Kanlux AKVO IP44 S are wall and ceiling luminaires in three colors: white, chrome and black. The luminaire is available in 3 lengths and three powers: 60cm - 15W, 80cm - 20W and 100cm - 23W. Kanlux AKVO S lamps can be mounted vertically and horizontally, on the wall or on the ceiling, which creates virtually unlimited arrangement possibilities. In addition, these lamps have increased resistance to moisture IP44, which means that you can safely mount them in the bathroom or laundry room. Kanlux AKVO IP44 S lamps are perfect for lighting rooms such as a bathroom, laundry room, utility room, corridor or wardrobe. Kanlux AKVO IP 44 S are equipped with a discreet switch located in the housing of the luminaire. These lamps have a high luminous efficiency, over 100 lumens per Watt, thanks to which they help you save electricity.

Enclosure material: aluminum alloy

Lampshade material: plastic



Artikelnummer	Code	Leistung [W]	Farbe	Leuchtdichte [lm/W]	Farbwiedergabe [Ra]	Leuchtwert [lm]	Temperatur [°C]
AKVO IP44 15W-NW-W S	36650	15	weiß   white	1600	80	4000	5+30
AKVO IP44 15W-NW-B S	36651	15	schwarz   black	1600	80	4000	5+30
AKVO IP44 15W-NW-C S	36652	15	chrom   chrome	1600	80	4000	5+30
AKVO IP44 20W-NW-W S	36653	20	weiß   white	2300	80	4000	5+30
AKVO IP44 20W-NW-B S	36654	20	schwarz   black	2300	80	4000	5+30
AKVO IP44 20W-NW-C S	36655	20	chrom   chrome	2300	80	4000	5+30
AKVO IP44 23W-NW-W S	36656	23	weiß   white	2750	80	4000	5+30
AKVO IP44 23W-NW-B S	36657	23	schwarz   black	2750	80	4000	5+30
AKVO IP44 23W-NW-C S	36658	23	chrom   chrome	2750	80	4000	5+30

[V] 220-240 AC	[Hz] 50	[h] 15000	[h] 25000	[Ra] 80	[SMD]	[mm] 0,75-1,5	[mm] 0,1m
[IP] 44	[°C] 5+30	[h]	[h]	[Ra]	[SMD]	[mm]	[mm]
[CE]	[EAC]	[UK CA]	[RoHS]	[RoHS]	[RoHS]	[RoHS]	[RoHS]

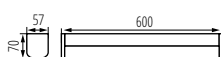

AKVO IP44 15W

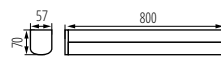

AKVO IP44 20W

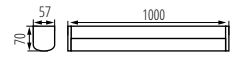

AKVO IP44 23W

# AKVO IP44

LED-WAND-DECKENLEUCHE ▶ WALL/CEILING LED FIXTURE

NEW

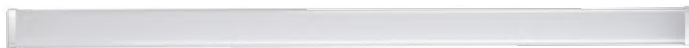

AKVO IP44 23W

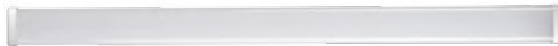

AKVO IP44 20W

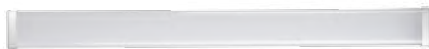

AKVO IP44 15W



AKVO IP44 15W-NW-W



AKVO IP44 15W-NW-B



AKVO IP44 15W-NW-C



Kanlux AKVO IP44 sind Wand- und Deckenleuchten in drei Farben: Weiß, Chrom und Schwarz. Die Leuchte ist in 3 Längen und drei Leistungen erhältlich: 60 cm – 15 W, 80 cm – 20 W und 100 cm – 23 W. Kanlux AKVO S-Leuchten können vertikal und horizontal, an der Wand oder an der Decke montiert werden, wodurch nahezu unbegrenzte Anordnungsmöglichkeiten entstehen. Darüber hinaus verfügen diese Lampen über eine erhöhte Feuchtigkeitsbeständigkeit IP44, sodass Sie sie sicher im Badezimmer oder in der Waschküche montieren können. Kanlux AKVO IP44 S-Lampen eignen sich perfekt für die Beleuchtung von Räumen wie Badezimmer, Waschküche, Hauswirtschaftsraum, Flur oder Garderobe. Kanlux AKVO IP 44 S sind mit einem dezenten Schalter ausgestattet, der sich im Gehäuse der Leuchte befindet. Diese Lampen haben eine hohe Lichtausbeute von über 100 Lumen pro Watt und helfen Ihnen so, Strom zu sparen.

Gehäusematerial: Aluminiumlegierung

Abdeckungsmaterial: Kunststoff

Kanlux AKVO IP44 are wall and ceiling luminaires in three colors: white, chrome and black. The luminaire is available in 3 lengths and three powers: 60cm - 15W, 80cm - 20W and 100cm - 23W. Kanlux AKVO lamps can be mounted vertically and horizontally, on the wall or on the ceiling, which creates virtually unlimited arrangement possibilities. In addition, these lamps have increased resistance to moisture IP44, which means that you can safely mount them in the bathroom or laundry room. Kanlux AKVO IP44 lamps are perfect for lighting rooms such as a bathroom, laundry room, utility room, corridor or wardrobe. These lamps have a high luminous efficiency, over 100 lumens per Watt, thanks to which they help you save electricity.

Enclosure material: aluminum alloy

Lampshade material: plastic

AKVO IP44 15W-NW-W	<b>36659</b>	5905339366597	15	weiß   white	1600 4000
AKVO IP44 15W-NW-B	<b>36660</b>	5905339366603	15	schwarz   black	1600 4000
AKVO IP44 15W-NW-C	<b>36661</b>	5905339366610	15	chrom   chrome	1600 4000
AKVO IP44 20W-NW-W	<b>36662</b>	5905339366627	20	weiß   white	2300 4000
AKVO IP44 20W-NW-B	<b>36663</b>	5905339366634	20	schwarz   black	2300 4000
AKVO IP44 20W-NW-C	<b>36664</b>	5905339366641	20	chrom   chrome	2300 4000
AKVO IP44 23W-NW-W	<b>36665</b>	5905339366658	23	weiß   white	2750 4000
AKVO IP44 23W-NW-B	<b>36666</b>	5905339366665	23	schwarz   black	2750 4000
AKVO IP44 23W-NW-C	<b>36667</b>	5905339366672	23	chrom   chrome	2750 4000

220-240 AC	50	15000	25000	80	SMD	
IP 44	5+30		0,75-1,5	0,1m		



AKVO IP44 15W

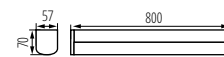

AKVO IP44 20W

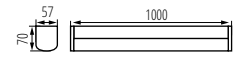

AKVO IP44 23W

# ERINUS LED

LED-WANDEINBAULEUCHE ▶ STAIRCASE LED LIGHT FITTING



ERINUS LED L W



ERINUS LED L W-WW	<b>33320</b>	5905339333209	12 DC	0,8	weiß   white	15	3000
ERINUS LED L W-NW	<b>33321</b>	5905339333216	12 DC	0,8	weiß   white	15	4000
ERINUS LED O W-WW	<b>33322</b>	5905339333223	12 DC	0,8	weiß   white	15	3000
ERINUS LED O W-NW	<b>33323</b>	5905339333230	12 DC	0,8	weiß   white	15	4000
ERINUS LED LL W-WW	<b>33324</b>	5905339333247	12 DC	1,5	weiß   white	30	3000
ERINUS LED LL W-NW	<b>33325</b>	5905339333254	12 DC	1,5	weiß   white	30	4000
ERINUS LED L GR-NW	<b>33327</b>	5905339333278	12 DC	0,8	grau   grey	15	4000
ERINUS LED LL GR-WW	<b>33330</b>	5905339333308	12 DC	1,5	grau   grey	30	3000
ERINUS LED LL GR-NW	<b>33331</b>	5905339333315	12 DC	1,5	grau   grey	30	4000
ERINUS LED L B-WW	<b>33332</b>	5905339333322	12 DC	0,8	schwarz   black	15	3000
ERINUS LED L B-NW	<b>33333</b>	5905339333339	12 DC	0,8	schwarz   black	15	4000
ERINUS LED O B-WW	<b>33334</b>	5905339333346	12 DC	0,8	schwarz   black	15	3000
ERINUS LED O B-NW	<b>33335</b>	5905339333353	12 DC	0,8	schwarz   black	15	4000
ERINUS LED LL B-WW	<b>33336</b>	5905339333360	12 DC	1,5	schwarz   black	30	3000
ERINUS LED LL B-NW	<b>33337</b>	5905339333377	12 DC	1,5	schwarz   black	30	4000

≥15000	30000	ellipse ≤ 60 MacAdam	Ra 80			IP 20		
	0,1m	SMD	5+25					

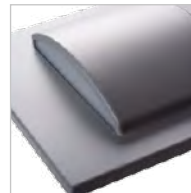

Kanlux ERINUS ist eine einzigartige Serie von Premium-Treppenhauseuchten aus Kunststoff. Diese Leuchten zeichnen sich durch außergewöhnliche Leichtigkeit aus, aufgrund der Materialien aus denen sie gemacht wurden, und in der gleichzeitig großartigen Präzision und Liebe zum Detail. Kanlux ERINUS sind sehr dünn, daher verschmelzen sie sich mit der Wandlinie und machen es dadurch diskret zur Dekoration. Wir haben drei Farben zur Auswahl: Wählen Sie zwischen drei Farben (weiß, schwarz und grau) und zwei Lichtfarben (warmes und neutrales Licht). Zusätzlich stehen drei verschiedene Modelle zur Auswahl von Leuchten. Das Kanlux ERINUS L ist eine quadratische Leuchte, die in eine Richtung leuchtet, das LL-Modell scheint in beide Richtungen und der Kanlux ERINUS O ist eine runde Leuchte, die in eine Richtung leuchtet.

Gehäusematerial: Kunststoff

Abdeckungsmaterial: Kunststoff

Kanlux ERINUS is a unique series of premium stairwaf fittings made of plastic. These luminaires are characterized by exceptional lightness due to the materials from which they were made, and at the same time they are made with great precision and attention to detail. Kanlux ERINUS are very thin, so they flush with the wall line and make it a discreet decoration. We have three colors to choose (white, black and gray), two colors of light (warm and neutral light) and three different models of luminaires. The Kanlux ERINUS L is a square luminaire glowing in one direction, the LL model shines in both directions, and the Kanlux ERINUS O is a round luminaire glowing in one direction.

Enclosure material: plastic

Lampshade material: plastic

Ø60

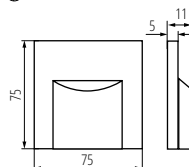

ERINUS LED L

Ø60

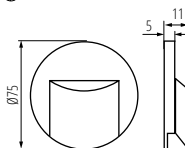

ERINUS LED O

Ø60

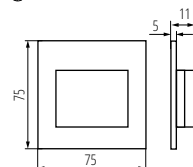

ERINUS LED LL

**Kanlux**

# ERINUS LED

LED-WANDEINBAULEUCHTE ▶ STAIRCASE LED LIGHT FITTING



ERINUS LED L B



ERINUS LED L W



ERINUS LED L GR

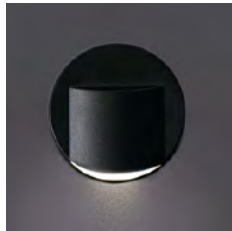

ERINUS LED O B



ERINUS LED O W

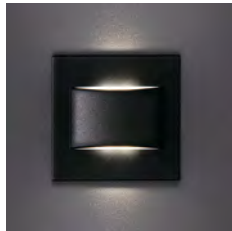

ERINUS LED LL B



ERINUS LED LL W



ERINUS LED LL GR



# APUS LED

LED-WANDEINBAULEUCHE ▶ STAIRCASE LED LIGHT FITTING



APUS LED AC



APUS LED PIR B



APUS LED B



APUS LED W

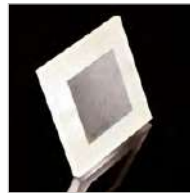

Kanlux APUS zeichnet sich durch ein modernes Design kombiniert mit einem attraktiven Leuchteffekt aus. Es ist eine großartige Idee, Treppen und Flure zu beleuchten oder die Inneneinrichtung zu betonen. Die einzigartige Konstruktion der Leuchte sorgt für eine gleichmäßige Lichtabstrahlung. Die AC-Version ist mit einem 230-V-Netzteil ausgestattet, das in die Hohlraumdose passt, und die PIR-Version besitzt einen Bewegungssensor. Der Sensor erfasst Bewegungen/schaltet die Beleuchtung unabhängig von der Lichtintensität in der Umgebung ein.

Gehäusematerial: Geschliffener Edelstahl, Kunststoff

Kanlux APUS means modern design combined with an attractive effect of lighting. It is a perfect idea to highlight stairs and corridors or to emphasize decor of rooms. The unique structure of the holders ensures even emission of light. The AC version is equipped with 230V power supply unit which fits into a box and the PIR version is equipped with a motion sensor. The sensor detects movement / turns lights on regardless of the ambient light intensity.

Enclosure material: polished stainless steel, plastic



APUS LED WW	<b>23106</b>	5905339231062	12 DC	0,8	Edelstahl   stainless steel	13	3000
APUS LED CW	<b>23107</b>	5905339231079	12 DC	0,8	Edelstahl   stainless steel	15	6500
APUS LED AC-WW	<b>23800</b>	5905339238009	220-240 AC	1,3	Edelstahl   stainless steel	13	3000
APUS LED AC-CW	<b>23801</b>	5905339238016	220-240 AC	1,3	Edelstahl   stainless steel	15	6500
APUS LED AC B-NW	<b>26536</b>	5905339265364	220-240 AC	1,3	schwarz   black	14	4000
APUS LED AC B-WW	<b>26537</b>	5905339265371	220-240 AC	1,3	schwarz   black	13	3000
APUS LED B-NW	<b>26538</b>	5905339265388	12 DC	0,8	schwarz   black	14	4000
APUS LED B-WW	<b>26539</b>	5905339265395	12 DC	0,8	schwarz   black	13	3000
APUS LED W-WW	<b>26840</b>	5905339268402	12 DC	0,8	weiß   white	13	3000
APUS LED W-CW	<b>26841</b>	5905339268419	12 DC	0,8	weiß   white	15	6500
APUS LED P68 B-NW CZ	<b>27084</b>	5905339270849	12 DC	0,8	schwarz   black	14	4000
APUS LED PIR WW	<b>27370</b>	5905339273703	12 DC	0,8	Edelstahl   stainless steel	13	3000
APUS LED W-NW	<b>27378</b>	5905339273789	12 DC	0,8	weiß   white	14	4000
APUS LED PIR NW	<b>27379</b>	5905339273796	12 DC	0,8	Edelstahl   stainless steel	14	4000
APUS LED PIR B-NW	<b>29856</b>	5905339298560	12 DC	0,8	schwarz   black	14	4000
APUS LED PIR B-WW	<b>29857</b>	5905339298577	12 DC	0,8	schwarz   black	13	3000
APUS LED NW	<b>32488</b>	5905339324887	12 DC	0,8	Edelstahl   stainless steel	14	4000

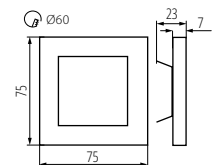

APUS LED

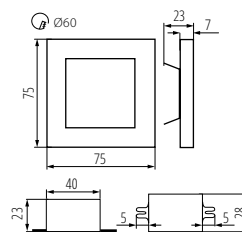

APUS LED AC

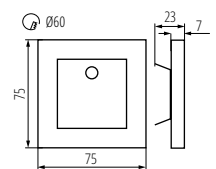

APUS LED PIR

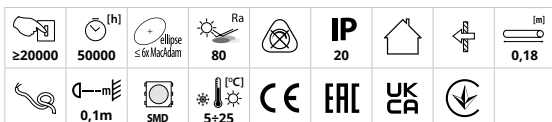

# TERRA LED

LED-WANDEINBAULEUCHTE ▶ STAIRCASE LED LIGHT FITTING



TERRA LED B; TERRA LED AC B



TERRA LED PIR B



TERRA LED W



Kanlux TERRA zeichnet sich durch ein modernes Design kombiniert mit einem attraktiven Leuchteffekt aus. Es ist eine großartige Idee, Treppen und Flure zu beleuchten oder die Inneneinrichtung zu betonen. Die einzigartige Konstruktion der Leuchte sorgt für eine gleichmäßige Lichtabstrahlung. Die AC-Version ist mit einem 230-V-Netzteil ausgestattet, das in die Hohlraumdose passt, und die PIR-Version besitzt einen Bewegungssensor. Der Sensor erfasst Bewegungen/schaltet die Beleuchtung unabhängig von der Lichtintensität in der Umgebung ein.

Gehäusematerial: Geschliffener Edelstahl, Kunststoff

Kanlux TERRA means modern design combined with an attractive effect of lighting. It is a perfect idea to highlight stairs and corridors or to emphasize decor of rooms. The unique structure of the holders ensures even emission of light. The AC version is equipped with 230V power supply unit which fits into a box and the PIR version is equipped with a motion sensor. The sensor detects movement / turns lights on regardless of the ambient light intensity.

Enclosure material: polished stainless steel, plastic

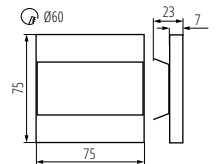

TERRA LED

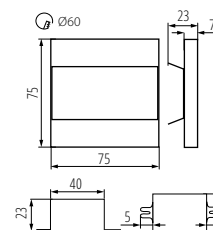

TERRA LED AC

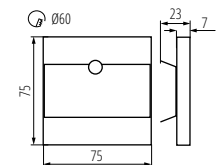

TERRA LED PIR B

	[V]	[W]	[lm]	[K]			
TERRA LED WW	23102	5905339231024	12 DC	0,8	Edelstahl   stainless steel	13	3000
TERRA LED CW	23104	5905339231048	12 DC	0,8	Edelstahl   stainless steel	15	6500
TERRA LED AC-WW	23806	5905339238061	220-240 AC	1,3	Edelstahl   stainless steel	13	3000
TERRA LED W-WW	26842	5905339268426	12 DC	0,8	weiß   white	13	3000
TERRA LED W-CW	26843	5905339268433	12 DC	0,8	weiß   white	15	6500
TERRA LED B-NW	26848	5905339268488	12 DC	0,8	schwarz   black	14	4000
TERRA LED B-WW	26849	5905339268495	12 DC	0,8	schwarz   black	13	3000
TERRA LED P68 CW CZ	27082	5905339270825	12 DC	0,8	Edelstahl   stainless steel	15	6500
TERRA LED P68 WW CZ	27083	5905339270832	12 DC	0,8	Edelstahl   stainless steel	13	3000
TERRA LED P68 B-NW CZ	27088	5905339270887	12 DC	0,8	schwarz   black	14	4000
TERRA LED P68 B-WW CZ	27089	5905339270894	12 DC	0,8	schwarz   black	13	3000
TERRA LED PIR B-NW	29860	5905339298607	12 DC	0,8	schwarz   black	14	4000
TERRA LED PIR B-WW	29861	5905339298614	12 DC	0,8	schwarz   black	13	3000

≥20000	50000	ellipse ≤ für Neckdam	Ra 80	IP 20			0,18
	SMD	5+25					

# SABIK LED

LED-WANDEINBAULEUCHE ▶ STAIRCASE LED LIGHT FITTING



SABIK LED; SABIK LED AC



SABIK LED PIR



SABIK MINI LED B



SABIK LED B



SABIK LED WW	<b>23108</b>	5905339231086	12 DC	0,8	Edelstahl   stainless steel	13	3000
SABIK MINI LED WW	<b>23109</b>	5905339231093	12 DC	0,8	Edelstahl   stainless steel	13	3000
SABIK LED CW	<b>23110</b>	5905339231109	12 DC	0,8	Edelstahl   stainless steel	15	6500
SABIK MINI LED CW	<b>23111</b>	5905339231116	12 DC	0,8	Edelstahl   stainless steel	15	6500
SABIK LED AC-WW	<b>23802</b>	5905339238023	220-240 AC	1,3	Edelstahl   stainless steel	13	3000
SABIK LED PIR WW	<b>27374</b>	5905339273741	12 DC	0,8	Edelstahl   stainless steel	13	3000
SABIK LED B-NW	<b>29852</b>	5905339298522	12 DC	0,8	schwarz   black	14	4000
SABIK LED B-WW	<b>29853</b>	5905339298539	12 DC	0,8	schwarz   black	13	3000
SABIK MINI LED B-NW	<b>29854</b>	5905339298546	12 DC	0,8	schwarz   black	14	4000
SABIK MINI LED B-WW	<b>29855</b>	5905339298553	12 DC	0,8	schwarz   black	13	3000
SABIK LED PIR B-NW	<b>29858</b>	5905339298584	12 DC	0,8	schwarz   black	14	4000
SABIK LED PIR B-WW	<b>29859</b>	5905339298591	12 DC	0,8	schwarz   black	13	3000
SABIK MINI LED NW	<b>32490</b>	5905339324900	12 DC	0,8	Edelstahl   stainless steel	14	4000

≥20000	50000	80	IP 20	0,18
SMD	5+25	CE	EAC	UK CA

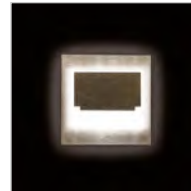
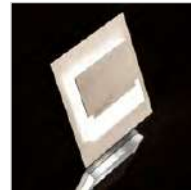
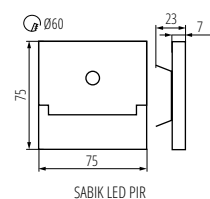
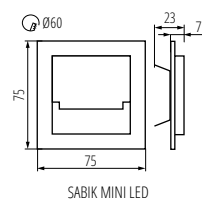
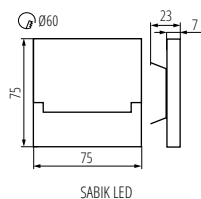
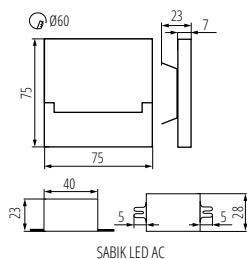

Kanlux SABIK zeichnet sich durch ein modernes Design kombiniert mit einem attraktiven Leuchteffekt aus. Es ist eine großartige Idee, Treppen und Flure zu beleuchten oder die Inneneinrichtung zu betonen. Die einzigartige Konstruktion der Leuchte sorgt für eine gleichmäßige Lichtabstrahlung. Die AC-Version ist mit einem 230-V-Netzteil ausgestattet, das in die Hohlraumdose passt, und die PIR-Version besitzt einen Bewegungssensor. Der Sensor erfasst Bewegungen/schaltet die Beleuchtung unabhängig von der Lichtintensität in der Umgebung ein.

Gehäusematerial: Geschliffener Edelstahl, Kunststoff

Kanlux SABIK means modern design combined with an attractive effect of lighting. It is a perfect idea to highlight stairs and corridors or to emphasize decor of rooms. The unique structure of the holders ensures even emission of light. The AC version is equipped with 230V power supply unit which fits into a box and the PIR version is equipped with a motion sensor. The sensor detects movement / turns lights on regardless of the ambient light intensity.

Enclosure material: polished stainless steel, plastic

# SOLA LED

LED-WANDEINBAULEUCHTE ▶ STAIRCASE LED LIGHT FITTING



SOLA LED



SOLA LED B; SOLA LED AC B

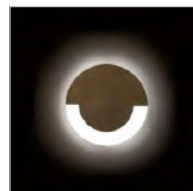

Kanlux SOLA zeichnet sich durch ein modernes Design kombiniert mit einem attraktiven Leuchteffekt aus. Es ist eine großartige Idee, Treppen und Flure zu beleuchten oder die Inneneinrichtung zu betonen. Die einzigartige Konstruktion der Leuchte sorgt für eine gleichmäßige Lichtabstrahlung. Die AC-Version ist mit einem 230-V-Netzteil ausgestattet, das in die Hohlraumdose passt.

Gehäusematerial: Geschliffener Edelstahl, Kunststoff

Kanlux SOLA means modern design combined with an attractive effect of lighting. It is a perfect idea to highlight stairs and corridors or to emphasize decor of rooms. The unique structure of the holders ensures even emission of light. The AC version is equipped with 230V power supply unit which fits into a box.

Enclosure material: polished stainless steel, plastic



SOLA LED VVV	<b>23100</b>	5905339231000	12 DC	0,8	Edelstahl   stainless steel	13	3000
SOLA LED AC-VVV	<b>23804</b>	5905339238047	220-240 AC	1,3	Edelstahl   stainless steel	13	3000
SOLA LED B-NW	<b>27558</b>	5905339275585	12 DC	0,8	schwarz   black	14	4000
SOLA LED B-VVV	<b>27559</b>	5905339275592	12 DC	0,8	schwarz   black	13	3000
SOLA LED NW	<b>32491</b>	5905339324917	12 DC	0,8	Edelstahl   stainless steel	14	4000

≥20000	50000	ellipse ≤ 60° Nachdäm	80	IP 20	0,18	0,1m	0,18
0,1m	SMD	5+25	CE	ENEC	TÜV	TÜV	

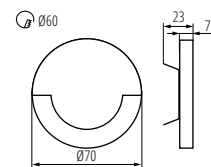

SOLA LED

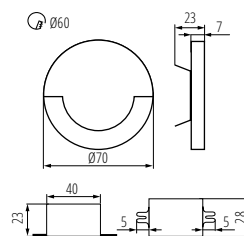

SOLA LED AC



Kanlux

# IRS 3XAAA

LED-WANDEINBAULEUCHE ► STAIRCASE LED LIGHT FITTING

**NEW**



IRS3XAAA LED PIR W-NW



Kanlux IRS ist eine wiederaufladbare Treppenleuchte, die mit drei AAA-Batterien betrieben wird. Die Lampe kann in einem von drei Modi betrieben werden: EIN – dauerhaft an/AUS – dauerhaft aus/AUTO – schaltet sich bei geringer Lichtintensität oder Bewegung ein (die Lampe verfügt über einen Dämmerungs- und Bewegungssensor). Sie können die Kanlux IRS-Lampe mit einem Klebeband oder zwei Montageschrauben (im Lieferumfang enthalten) montieren. Ein großer Vorteil der Lampe ist die Möglichkeit, sie an Orten zu installieren, an denen keine Elektroinstallation vorhanden ist.

Gehäusematerial: Kunststoff  
Abdeckungsmaterial: Kunststoff

Kanlux IRS is a rechargeable stair lamp powered by three AAA batteries. The lamp can operate in one of three modes - ON - permanently on/OFF - permanently off/AUTO - turns on at low light intensity or movement (the lamp has a twilight and motion sensor). You can mount the Kanlux IRS lamp using a tape or two mounting screws (included). A big advantage of the lamp is the ability to install it in places where there is no electrical installation.

Enclosure material: plastic  
Lampshade material: plastic



IRS3XAAA LED PIR W-NW | 37392 | 5905339373922 | 3 x 1,5 DC | 0,3 | weiß | white | 10 | 4000

25000	Ra 80		IP 54			0,1m	0+25
33	max 5	20--					

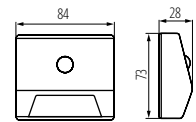

IRS3XAAA LED PIR W-NW

Kanlux

# MEFIS LED

LED-WANDEINBAULEUCHE ► STAIRCASE LED LIGHT FITTING



MEFIS LED W-NW



MEFIS LED B-NW



Kanlux MEFIS LED ist eine untypische Serie von Treppenhausleuchten. Diese Leuchte ist in den Farben weiß, schwarz und grau erhältlich, so dass Sie die richtige Farbe für Ihre Einrichtung wählen können. Die Kanlux MEFIS LED-Leuchte hat eine ungewöhnliche Form und einen fokussierten Lichtstrahl, so dass sie die Punkte beleuchtet, die Ihnen wichtig sind.

Gehäusematerial: Kunststoff

Kanlux MEFIS LED is an untypical series of stair fittings. This fitting is available in white, black and grey colours, thus you can choose the colour that matches the interior. Kanlux MEFIS LED fitting is in an original shape and is characterized by a focused luminous flux, thus you can direct it so that it will light points which you wish.

Enclosure material: plastic



MEFIS LED W-NW | 32495 | 5905339324955 | 12 DC | 0,7 | weiß | white | 35 | 4000  
MEFIS LED B-NW | 32497 | 5905339324979 | 12 DC | 0,7 | schwarz | black | 35 | 4000

≥20000	50000	Ra 80	IP 20			0,18	5+25

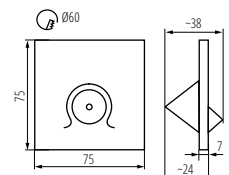

MEFIS LED

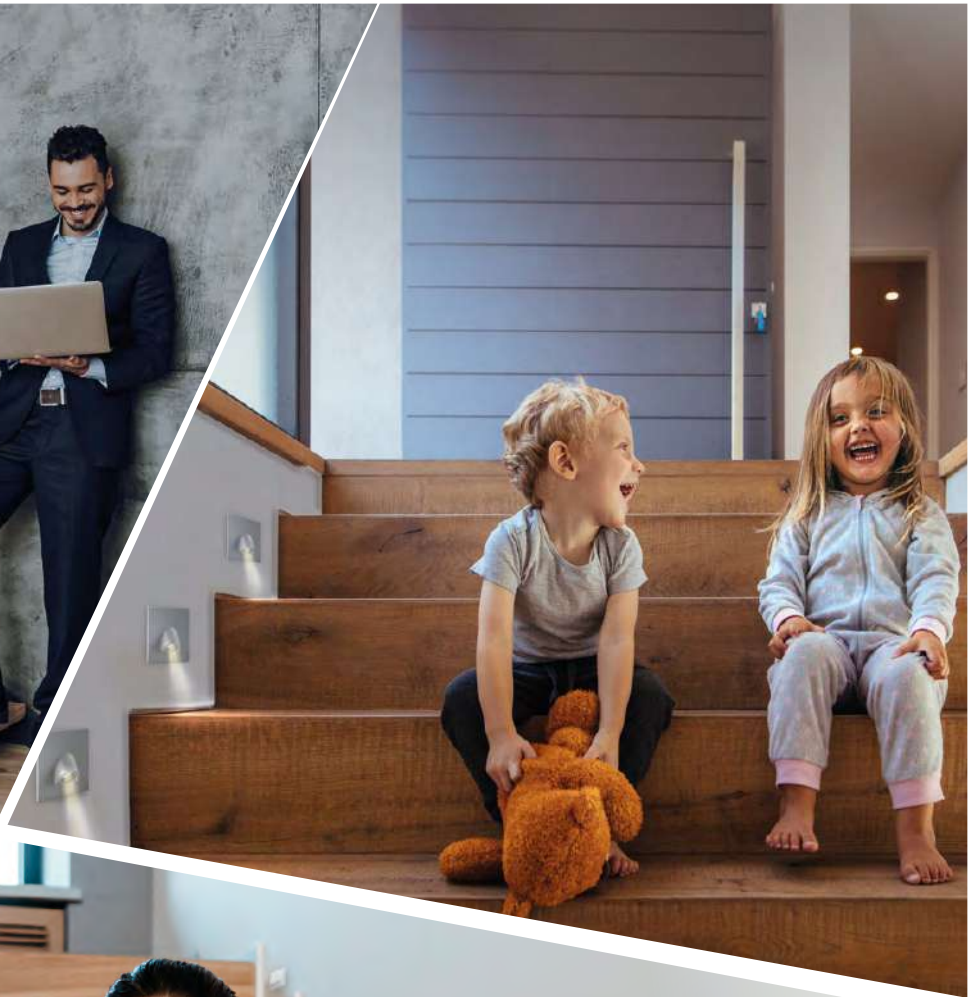
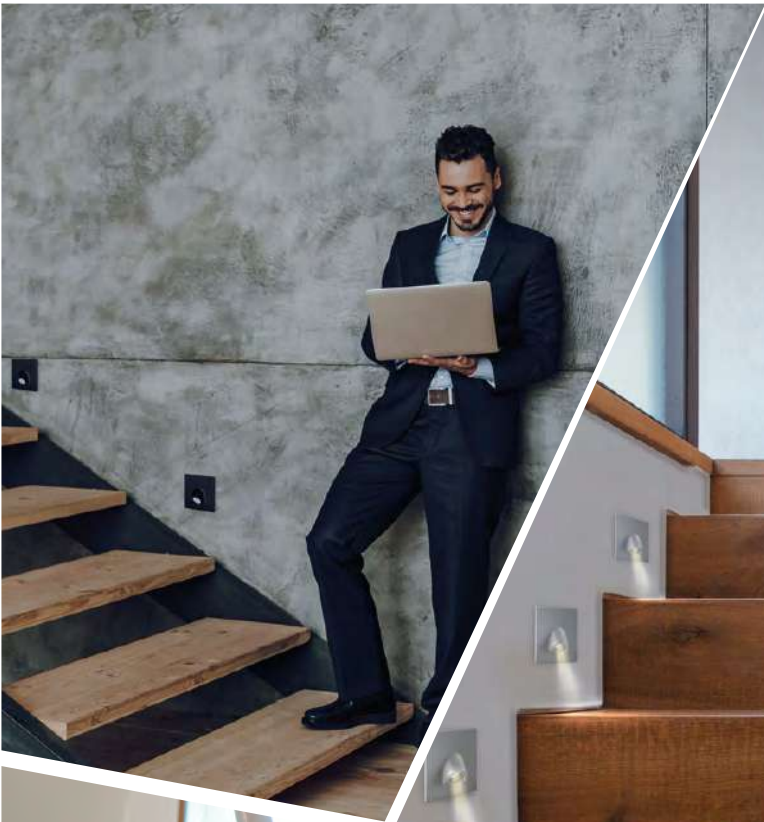

# Kanlux ZEPO

MÖBELUNTERBAULEUCHE ▶ UNDER-CABINET SPOTLIGHT FITTING



ZEPO LFD-T02/S-W



ZEPO LFD-T02/S-B



ZEPO LFD-T02/S-W



ZEPO LFD-T02-C/M



ZEPO LFD-T02-B



ZEPO LFD-T02-W

Kanlux ZEPO-Spotleuchten ist eine Beleuchtung, die unter anderem für Schränke über der Küchenarbeitsplatte gedacht ist. ZEPO sind in einer Version mit und ohne Schalter erhältlich. In den Spotleuchten wird das Leuchtmittel mit einem G4-Sockel verwendet. Die Leuchten ZEPO LFD-T02/S-C, ZEPO LFD-T02/S-C/M, ZEPO LFD-T02/S-BR/M sind mit einem Schalter ausgestattet.

Die Leuchte ZEPO LFD-T02/S-C/M ist mit einem Einschalter ausgestattet

Gehäusematerial: Stahl

Abdeckungsmaterial: Glas

The Kanlux ZEPO series of eyes is the lighting intended under cabinets, for example, above a table top in a kitchen. ZEPOs are available in a version with an OFF switch and without it. JC with G4 thread is a light source intended for the eyes.

ZEPO LFD-T02/S-C/M light fixtures provided with a power switch

Enclosure material: steel

Lampshade material: glass



ZEPO LFD-T02-C/M	<b>04381</b>	5905339043818	max 10	Chrom matt   chrome matte	
ZEPO LFD-T02/S-C/M	<b>04386</b>	5905339043863	max 10	Chrom matt   chrome matte	✓
ZEPO LFD-T02-B	<b>36630</b>	5905339366306	max 10	schwarz   black	
ZEPO LFD-T02-W	<b>36631</b>	5905339366313	max 10	weiß   white	
ZEPO LFD-T02/S-B	<b>36632</b>	5905339366320	max 10	schwarz   black	✓
ZEPO LFD-T02/S-W	<b>36633</b>	5905339366337	max 10	weiß   white	✓

NEW

12 AC; 12 DC		IP 20			
0,5m	0,1	5+25			

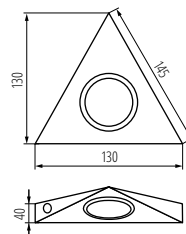

ZEPO LFD-T02/S

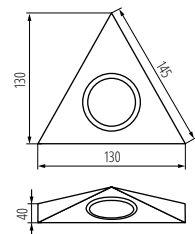

ZEPO LFD-T02

# MERA LED

LED-MÖBELUNTERBAULEUCHE ▶ LED UNDER CABINET FITTING



MERA LED 5W NW



MERA LED 10W NW



MERA LED 15W NW



MERA LED 20W NW

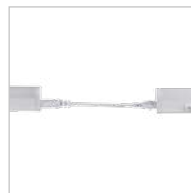

Kanlux MERA LED ist eine Unterschrankleuchte mit integrierten LED´s. Die Leuchten sind in Größen von 28 bis 114 cm erhältlich. Außerdem können sie in Reihen (bis zu 5 Leuchten) mithilfe von Kanlux MERA LED PP-Verbindern angeschlossen werden.

Gehäusematerial: Kunststoff  
Abdeckungsmaterial: Kunststoff

Kanlux MERA LED is an under-cupboard luminaire with an integrated LED light source. The luminaires are available in sizes ranging from 28 to 114 cm. Moreover, we can connect them in lines (up to 5 luminaires) using Kanlux MERA LED PP connectors.

Enclosure material: plastic  
Lampshade material: plastic



MERA LED 5W NW	<b>29210</b>	5905339292100	5	weiß   white	490	4000
MERA LED 10W NW	<b>29211</b>	5905339292117	10	weiß   white	1040	4000
MERA LED 15W NW	<b>29212</b>	5905339292124	15	weiß   white	1600	4000
MERA LED 20W NW	<b>29213</b>	5905339292131	20	weiß   white	2030	4000

<b>[V]</b> 220-240 AC	<b>[Hz]</b> 50	<b>[°]</b> 150	<b>[h]</b> ≥15000	<b>[h]</b> 30000	<b>[lm]</b> ≥6000	<b>Ra</b> 80	<b>SMD</b>	<b>IP</b> 20
							<b>CE</b>	<b>ERC</b>
			<b>0,3m</b>	<b>1,5</b>	<b>5+25</b>		<b>UK</b>	<b>CA</b>

ZUBEHÖR ▶ ACCESSORIES

MERA LED PP | **29214** | 5905339292148 Kabel für den Anschluss von MERA LED PP-Leuchten | Luminaire connecting cable MERA LED PP

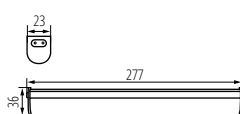

MERA LED 5W NW



MERA LED 10W NW



MERA LED 15W NW

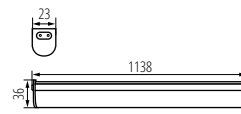

MERA LED 20W NW

# Kanlux LINUS LED

LED-MÖBELUNTERBAULEUCHTE ► LED UNDER CABINET FITTING



Die Unterschrankleuchte Kanlux LINUS hat ein klassisches und universelles Design. Dank ihrer kompakten Größe ist die Leuchte ideal für die Beleuchtung verschiedener Arten von Möbeln, Schränken und Regalen. Der LINUS LED-Kanal kann über ein LINUS LINK-Kabel angeschlossen werden.

Gehäusematerial: Kunststoff  
Abdeckungsmaterial: Kunststoff

Kanlux LINUS LED under-cabinet holder has classic and universal design. Thanks to its compact dimensions, the lamp will ideally highlight different types of furniture, cabinets and shelves. Kanlux LINUS LED can be combined on a pass-through basis by means of LINUX LINK cable.

Enclosure material: plastic  
Lampshade material: plastic



LINUS LED 4W-NW



LINUS LED 7W-NW



LINUS LED 4W-NW	<b>27590</b>	5905339275905	4	weiß   white	390	4000
LINUS LED 7W-NW	<b>27591</b>	5905339275912	7	weiß   white	760	4000

[V]	[Hz]	[lm]	[h]	Ra	SMD	IP
220-240 AC	50	≥15000	30000	80		20
[m]	[m]	[m]	[m]	[°C]	CE	UK CA
1,5	0,1m	5+25				

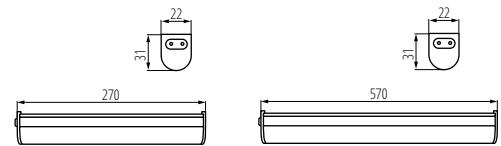

LINUS LED 4W

LINUS LED 7W

## ZUBEHÖR ► ACCESSORIES

LINUS LINK | **14977** | 5907540960618 | LINUS LINK-Leuchtenanschlusskabel | Luminaire connecting cable LINUS LINK

# Kanlux HAXA LED

EINBAU-DOWNLIGHT ► LED MIRROR LIGHT FITTING



HAXA-DSO



Wand-Deckenspotleuchte Kanlux HAXA LED ist eine kleine Spotleuchte, die als ergänzende Beleuchtung verwendet wird.

Für den ordnungsgemäßen Betrieb wird ein elektronisches Netzgerät für Gleichstrom 350 mA benötigt, zum Beispiel ADI 350 oder RICO, erhältlich im Angebot von Kanlux

Gehäusematerial: Aluminiumlegierung  
Abdeckungsmaterial: Kunststoff

The wall and ceiling spot-beam holder Kanlux HAXA LED is a small eye to be used as additional lighting.

An electronic 350-mA DC power supply unit is required for proper functioning, e.g. ADI 350 or RICO available from Kanlux

Enclosure material: aluminum alloy  
Lampshade material: plastic

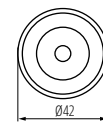
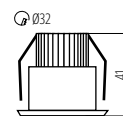

HAXA-DSO

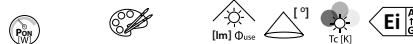

HAXA-DSO POWER LED-B	<b>08103</b>	5905339081032	1,2	Aluminium   aluminium	110	20	3000	F
----------------------	--------------	---------------	-----	-----------------------	-----	----	------	---

In [mA]	[h]	Ra	IP	[m]	[°C]
350	≥20000	40000	20	0,1	5+25
[mm]	[mm]	[m]	[°C]	[m]	[m]
0,1	Ø32	0,1m	90°		

# Kanlux GAVI LED

LED-MÖBELEINBAULEUCHTE ▶ LED SPOTLIGHT FITTING FOR FURNITURE UNITS



GAVI LED18 SMD-WW-C/M



GAVI LED18 SMD-WW-C/M | 19761 | 5905339197610 | 0,8 | Chrom matt | chrome matte | 42 | 3000

[V] 12 DC		$\geq 15000$	$30000$	$\leq 6$ (Max) däm	Ra 80	SMD			IP 20	
$5+25$	$0,1m$	$0,14$	$0,14$	$53$	lm W	CE	ERC	UK CA		

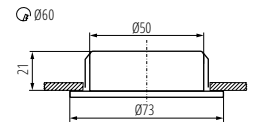

GAVI LED18 SMD-WW-C/M

# Kanlux GAVI

MÖBELEINBAULEUCHTE ▶ SPOTLIGHT FITTING FOR FURNITURE UNITS



GAVI CT-2116B-W



GAVI CT-2116B-W	00810	5905339008107	max 10	weiß   white
GAVI CT-2116B-C	00811	5905339008114	max 10	chrom   chrome
GAVI CT-2116B-C/M	00815	5905339008152	max 10	Chrom matt   chrome matte

[V] 12 AC; 12 DC	G4			IP 20		$5+25$	
$0,5m$	$0,60$		CE	ERC	UK CA		



GAVI CT-2116B-C



GAVI CT-2116B-C/M

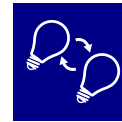

Kanlux GAVI sind Möbelleuchten aus Glas und Stahl. Durch die natürlichen Farben lassen sie sich dezent in den Montageort einfügen.

Gehäusematerial: Stahl

Kanlux GAVI are furniture fittings made of glass and steel. Unpretentious colour scheme allows them to discretely fit into the place of assembly.

Enclosure material: steel

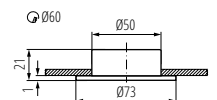

GAVI CT-2116B



Kanlux GAVI LED sind Möbelleuchten aus Glas und Stahl. Durch die natürlichen Farben lassen sie sich dezent in den Montageort einfügen. Kanlux GAVI LED Leuchten verfügen über ein integriertes Leuchtmittel.

Für den ordnungsgemäßen Betrieb wird ein elektronisches Netzgerät für Gleichstrom 350 mA benötigt, zum Beispiel: ADI 350 oder RICO, erhältlich im Angebot von Kanlux  
Gehäusematerial: Stahl

Kanlux GAVI LED are furniture fittings made of glass and steel. Unpretentious colour scheme allows them to discretely fit into the place of assembly. Kanlux GAVI LED holders have an integrated source of light

an electronic 350-mA DC power supply unit is required for proper functioning, e.g. ADI 350 or RICO available from Kanlux  
Enclosure material: steel

# ***Kanlux***

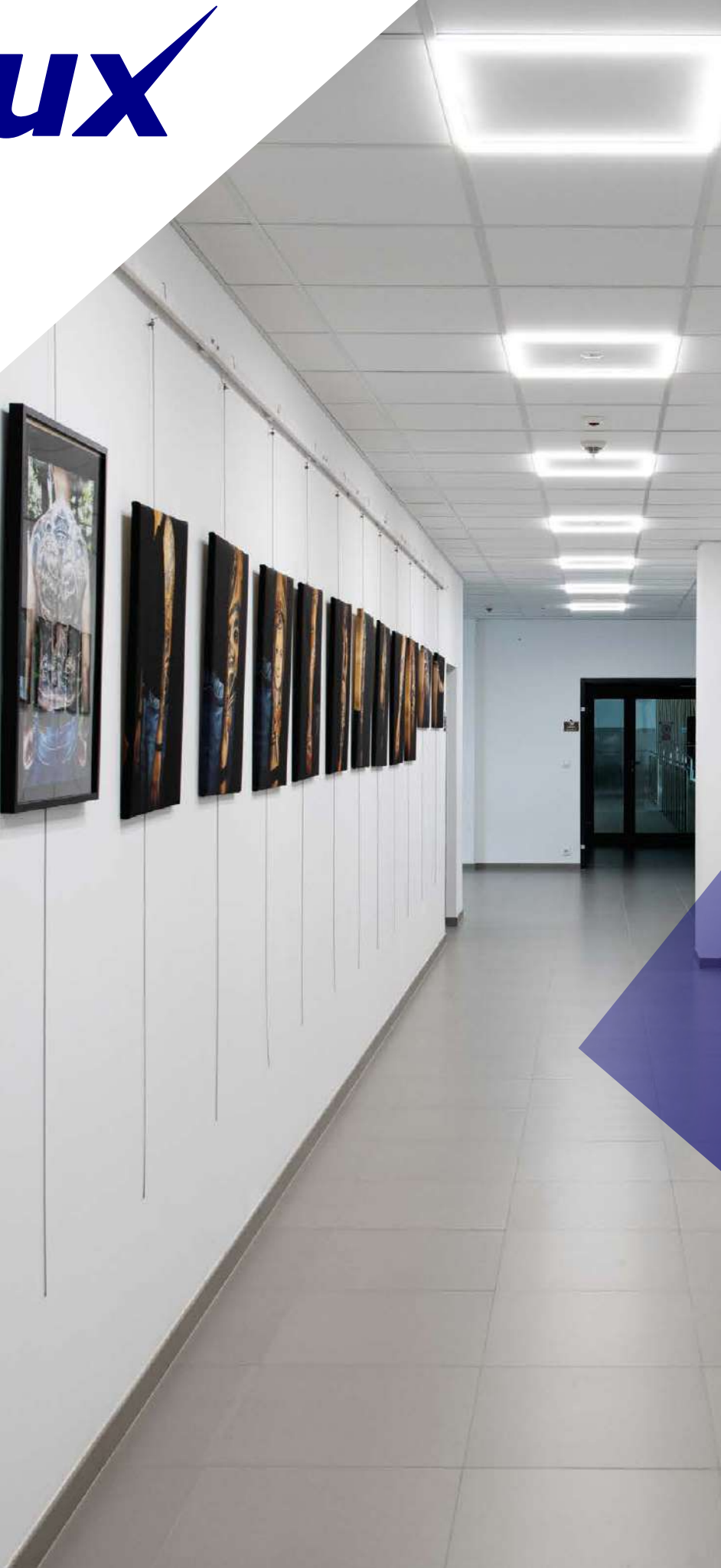



**TECHNISCHE LEUCHTEN  
UND ARCHITEKTURLEUCHTEN**

TECHNICAL AND ARCHITECTURAL FIXTURES

**Wir beleuchten bereits tausende von  
Wohnungen, hunderte von Bürogebäuden  
und Anlagengebäuden.**

**Wir wachsen, indem wir mit der rasanten  
Technologie Schritt halten, aber auch auf  
Ihre Bedürfnisse eingehen.**

We are already lighting up thousands of flats,  
and hundreds of offices and investment buildings.  
We are developing at the same rate as all  
the develop keeping pace with fast  
evolving technology, all the while listening  
to your needs.



*Photometrische Daten finden Sie unter:  
photometric data you can find on:*

► [kanlux.com](https://www.kanlux.com)



# BLINGO BL

LED-EINLEGE-PANEL ► RECESSED-MOUNTED LED PANEL



NEW



BLINGO 6060



BLINGO 12030

							UGR	IP	DRIVER integrated		
BLINGO 24W 4320 60NW	<b>37178</b>	5905339371782	24	4320	180	4000	115	weiß   white	20	✓	
BLINGO U24W 4000 60NW	<b>37179</b>	5905339371799	24	4000	166	4000	90	weiß   white	<19	20	✓
BLINGO 34W 4080 60NW	<b>37171</b>	5905339371713	34	4080	120	4000	115	weiß   white	20	✓	
BLINGO 34W 3740 60WW	<b>37170</b>	5905339371706	34	3740	110	3000	115	weiß   white	20	✓	
BLINGO 34W 4080 60CW	<b>37172</b>	5905339371720	34	4080	120	6500	115	weiß   white	20	✓	
BLINGO U34W 4080 60NW	<b>37173</b>	5905339371737	34	4080	120	4000	90	weiß   white	<19	20	✓
BLINGO 34W 4080 120NW	<b>37174</b>	5905339371744	34	4080	120	4000	115	weiß   white	20	✓	
BLINGO U34W 4080 120N	<b>37175</b>	5905339371751	34	4080	120	4000	90	weiß   white	<19	20	✓
BLINGO 38W 4560 60NW	<b>37176</b>	5905339371768	38	4560	120	4000	115	weiß   white	20	✓	
BLINGO 38W 4560 120NW	<b>37177</b>	5905339371775	38	4560	120	4000	115	weiß   white	20	✓	
BLINGO TN38W 6060 NW	<b>33177</b>	5905339331779	38	5400	142	4000	115	weiß   white	20	✓	
BLINGO TUN48W 6060 NW	<b>33179</b>	5905339331793	48	6250	130	4000	90	weiß   white	<19	20	✓
BLINGO PU 36W 6262 NW	<b>33188</b>	5905339331885	36	4320	120	4000	90	weiß   white	<19	20	-
BLINGO TN24-28W6060NW	<b>33178</b>	5905339331786	24/ 26/28	3400/3600/4000	do 142	4000	115	weiß   white	20	-	
BLINGO IPRN38W 6060NW	<b>33174</b>	5905339331748	38	3800	100	4000	115	weiß   white	44/20	-	

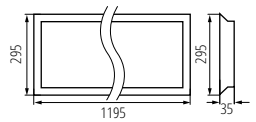

BLINGO 12030

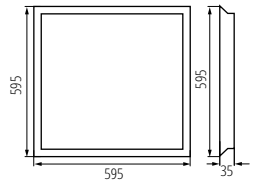

BLINGO 6060

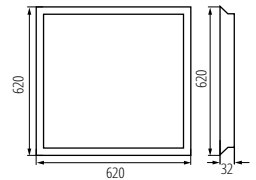

BLINGO 6262

 220-240 AC	 50	 ≥50000	 50000	 ≤60° / 60° Beam	 Ra 80	 SMD
		<b>IP</b> 20		 5-25		 1-2,5
 0,5m	<b>CE</b>	<b>ErC</b>	<b>UK</b> CA			



# Kanlux BLINGO BL

LED-EINLEGE-PANEL ► RECESSED-MOUNTED LED PANEL



Kanlux BLINGO BL LED sind Panels für die Hintergrundbeleuchtung. Sie sind mit einer Abzweigdose mit Schnellanschluss ausgestattet, die es ermöglicht, die Paneele miteinander zu verbinden und ihre Installation zu beschleunigen. In die neuen Modelle der bekannten Kanlux BLINGO BL LED Paneele haben wir ein integriertes Netzteil eingebaut, dank dem wir sie in den entsprechenden Kanlux ADTR-Rahmen einsetzen und die Aufbaumontage der Paneele durchführen können. Die Panels BLINGO BL LED haben einen gewellten Rahmen und eine höhere Lichtausbeute als ihre Vorgängerversionen (Kanlux BLINGO LED).

5 Jahre Garantie gemäß den Bedingungen der Garantieerklärung, die auf der Website verfügbar ist

Gehäusematerial: Stahl

Abdeckungsmaterial: Kunststoff

Panel-/Rahmenmaterial: Stahl

Kanlux BLINGO LED are backlight panels. They are equipped with a junction box with a quick connector, which allows for pass-through connection of panels and speeds up their installation. In most panels from the Kanlux BLINGO LED family, the power supply has been integrated with the luminaire, thanks to which we can, among others: place them in any Kanlux ADTR frame and perform surface-mounted panels.\* In addition, a whole range of accessories for Kanlux BLINGO panels is available (including GK clips and suspended cables).

\*In the BLINGO TN24-28W6060NW, BLINGO IPRN38W 6060NW and BLINGO PU 36W 6262 NW models, the power supply is not connected to the fixture, they must be connected to the appropriate Kanlux ADTR-H frame.

5 years Warranty under the terms of the warranty statement, available on our website

Enclosure material: steel

Lampshade material: plastic

Panel/frame material: steel

	INDEX	BLINGO 24W 4320 60NW	BLINGO U24W 4000 60NW	BLINGO 34W 4080 60NW	BLINGO 34W 3740 60WW	BLINGO 34W 4080 60CW	BLINGO U34W 4080 60NW	BLINGO 34W 4080 120NW	BLINGO U34W 4080 120N	BLINGO 38W 4560 60NW	BLINGO 38W 4560 120NW	BLINGO TN38W 6060 NW	BLINGO TUN48W 6060 NW	BLINGO PU 36W 6262 NW	BLINGO TN24-28W6060NW	BLINGO IPRN38W 6060NW
		37178	37179	37171	37170	37172	37173	37174	37175	37176	37177	33177	33179	33188	33178	33174
SPN PANEL 120	37336							✓	✓		✓					
SPN PANEL 60-62	37335	✓	✓	✓	✓	✓	✓			✓		✓	✓	✓	✓	✓
CLIPS PANEL 120	37338							✓	✓		✓					
CLIPS PANEL 60-62	37337	✓	✓	✓	✓	✓	✓			✓		✓	✓	✓	✓	✓
ADTR 6060 B	27615	✓	✓	✓	✓	✓	✓			✓		✓	✓			
ADTR 6060 SR	27610	✓	✓	✓	✓	✓	✓			✓		✓	✓			
ADTR 6060 W	27613	✓	✓	✓	✓	✓	✓			✓		✓	✓			
ADTR-S 6060 W	27616	✓	✓	✓	✓	✓	✓			✓		✓	✓			
ADTR 12030 B	27614							✓	✓		✓					
ADTR 12030 SR	27612							✓	✓		✓					
ADTR 12030 W	27611							✓	✓		✓					
ADTR-H 6060 B	29845	✓	✓	✓	✓	✓	✓			✓		✓	✓		✓	✓
ADTR-H 6060 SR	29844	✓	✓	✓	✓	✓	✓			✓		✓	✓		✓	✓
ADTR-H 6060 W	29843	✓	✓	✓	✓	✓	✓			✓		✓	✓		✓	✓
ADTR-S-H 6060 W	27617	✓	✓	✓	✓	✓	✓			✓		✓	✓		✓	✓
ADTR-H 76MM 6060 W	33398	✓	✓	✓	✓	✓	✓			✓		✓	✓		✓	✓
ADTR-H 12030 B	33391							✓	✓		✓					
ADTR-H 12030 SR	33392							✓	✓		✓					
ADTR-H 12030 W	33390							✓	✓		✓					
ADTR-H 6262 W	33435													✓		



ADTR W, SR, B

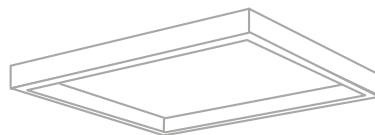

ADTR 6060 - 600 x 600 x 45mm  
ADTR-H 6060 - 600 x 600 x 65mm  
ADTR-H 6262 - 627 x 627 x 65mm  
ADTR-H 76MM - 600 x 600 x 76mm

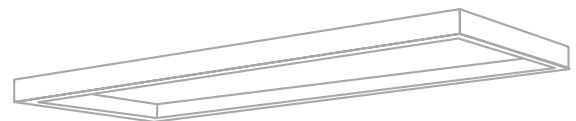

ADTR 12030 - 1200 x 300 x 45mm  
ADTR-H 12030 - 1200 x 300 x 65mm

# BLINGO CV

LED-EINLEGE-PANEL ▶ RECESSED-MOUNTED LED PANEL



NEW



BLINGO U E125LM 60NW



BLINGO U E125LM 120NW

						Driver [index]
BLINGO U E125LM 30NW	<b>37271</b>	5905339372710	max 21,6	3000	weiß   white	37272 (600mA, 24W)
BLINGO U E125LM 60NW	<b>37265</b>	5905339372659	max 36	4000\5000	weiß   white	37269 (850mA, 32W); 37270 (1100mA, 40W)
BLINGO U E125LM 120NW	<b>37266</b>	5905339372666	max 36	4000\5000	weiß   white	37269 (850mA, 32W); 37270 (1100mA, 40W)

90	≥50000	50000	Tc [K] 4000	Ra 80	SMD
IP 20	5+25	0,5m			
UGR 19					

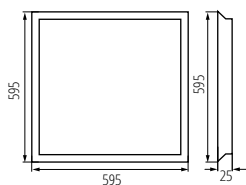

BLINGO U E125LM 60NW

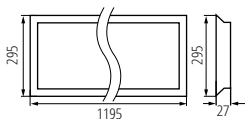

BLINGO U E125LM 120NW

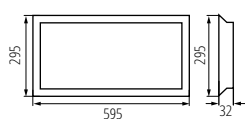

BLINGO U E125LM 30NW



LOW UGR



5  
WARRANTY  
5 years



PANEL  
2020



BACKLITE  
PANEL LED



HIGH  
lumen

Kanlux BLINGO CV Panels haben eine mikroprismatische Struktur des Diffusors, die den Blendeffekt reduziert (niedrigerer UGR-Index). Die Lebensdauer des Produkts beträgt 50.000 Stunden, was uns erlaubt, eine 5-Jahres-Garantie auf diese Panels zu gewähren.

Kanlux BLINGO CV sind nicht mit einem Netzteil ausgestattet. Sie können mit speziellen Netzteilen mit Steuerbarkeit (1-10V oder DALI) und ON-OFF-Netzteilen ausgestattet werden.

5 Jahre Garantie gemäß den Bedingungen der Garantieerklärung, die auf der Website verfügbar ist

Kanlux BRAVO LED-Panels werden ohne Netzteil geliefert.

Für den ordnungsgemäßen Betrieb wird ein entsprechendes LED-Netzteil benötigt, das im Angebot von Kanlux erhältlich ist.

Gehäusematerial: Stahl

Abdeckungsmaterial: Kunststoff

Panel-/Rahmenmaterial: Stahl

Kanlux BLINGO CV panels have a microprismatic structure of the lampshade, which reduces the glare effect (lower UGR index). The durability of the product is 50,000 hours, which allows us to provide a 5-year warranty on these panels. Kanlux BLINGO CV do not have a power supply included, they can be equipped with dedicated power supplies with controllability (1-10V or DALI) and ON-OFF power supply units.

5 years Warranty under the terms of the warranty statement, available on our website

Enclosure material: steel

Lampshade material: plastic

Panel/frame material: steel

# BLINGO CV

LED-EINLEGE-PANEL ► RECESSED-MOUNTED LED PANEL

LED-NETZTEIL ► DRIVER



SEC(mA)



BLINGO DALI SET 38W	<b>28515</b>	5905339372727	45	800	DALI
BLINGO DRV42W DALI BK	<b>37267</b>	5905339372697	42	450-1100	DALI
BLINGO DRV40W1-10V BK	<b>37268</b>	5905339372703	40	600-1050	1-10V
BLINGO DRV 32W ON-OFF	<b>37269</b>	5905339372680	32	850	-
BLINGO DRV 40W ON-OFF	<b>37270</b>	5905339372673	40	1100	-
BLINGO DRV 24W ON-OFF	<b>37272</b>	5905339285157	24	600	-

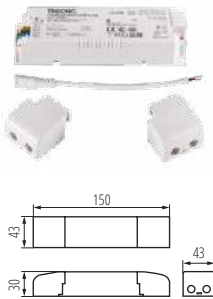

BLINGO DALI SET 38W

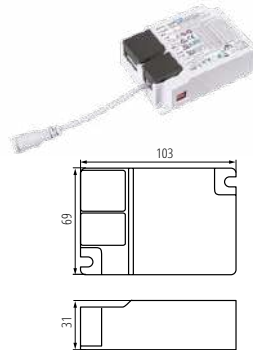

BLINGO DRV40W1-10V BK 37268  
BLINGO DRV42W DALI BK 37267

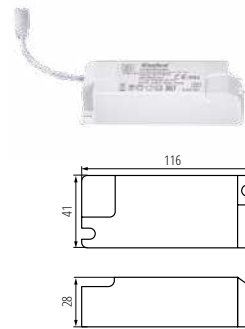

BLINGO DRV 24W ON-OFF 37272  
BLINGO DRV 32W ON-OFF 37269  
BLINGO DRV 40W ON-OFF 37270

	INDEX	BLINGO U	BLINGO U	BLINGO U
		E125LM 30NW	E125LM 60NW	E125LM 120NW
BLINGO DRV 24W ON-OFF	<b>37272</b>	✓		
BLINGO DRV 32W ON-OFF	<b>37269</b>		✓	✓
BLINGO DRV 40W ON-OFF	<b>37270</b>		✓	✓
BLINGO DRV40W1-10V BK	<b>37268</b>	✓	✓	✓
BLINGO DRV42W DALI BK	<b>37267</b>	✓	✓	✓
BLINGO DALI SET 38W	<b>28515</b>	✓	✓	✓
SPN PANEL 120	<b>37336</b>			✓
SPN PANEL 60-62	<b>37335</b>	✓	✓	
CLIPS PANEL 120	<b>37338</b>			✓
CLIPS PANEL 60-62	<b>37337</b>	✓	✓	
ADTR-H 6060 W	<b>29843</b>		✓	
ADTR-H 12030 W	<b>33390</b>			✓
ADTR-H 3060 W	<b>33393</b>	✓		



CLIPS PANEL 120



SPN PANEL 120

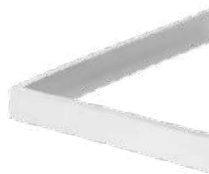

ADTR-H-W

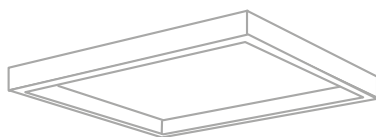

ADTR-H 6060 - 600 x 600 x 65mm

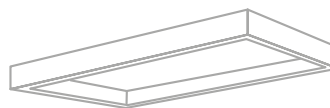

ADTR-H 3060 - 300 x 600 x 65mm



ADTR-H 12030 - 1200 x 300 x 65mm

# BRAVO LED

LED-EINLEGE-PANEL ▶ RECESSED-MOUNTED LED PANEL



BRAVO PU 36W6060



BRAVO PU 28W3060



BRAVO S 40W6060



BRAVO S 40W12030

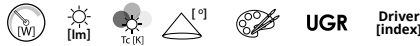

BRAVO PU 36W6060NWW	<b>28002</b>	5905339280022	36	4320	4000	110	weiß   white	>19	28025	
BRAVO PU 28W3060NWW	<b>28551</b>	5905339285515	28	3360	4000	90	weiß   white	>19	28029	
BRAVO S 40W6060NWW	<b>28010</b>	5905339280107	40	4000	4000	110	weiß   white		28026	
BRAVO S 40W12030NWW	<b>28022</b>	5905339280220	40	4000	4000	110	weiß   white		28026	

≥15000	30000	≤ für MacAdam	Ra 80	SMD	II	IP 20		5+25	
0,05	0,5	0,5	0,5m						

LED-NETZTEIL ▶ DRIVERS

BRAVO DRIVER 28W	<b>28029</b>	
BRAVO DRIVER 36W	<b>28025</b>	
BRAVO DRIVER 40W	<b>28026</b>	
BRAVO DALI SET 36W	<b>28508</b>	

IN OUT

220-240V~	50/60		8 cm	
	0,75 - 1,5			



BRAVO DRIVER

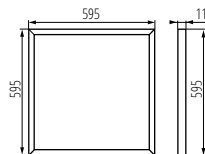

BRAVO 6060

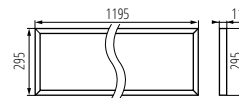

BRAVO 12030

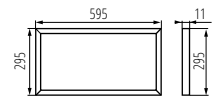

BRAVO 3060

# BRAVO LED

LED-EINLEGE-PANEL ► RECESSED-MOUNTED LED PANEL



Kanlux BRAVO-Panels sind speziell ausgewählte Komponenten für noch mehr Zufriedenheit bei ihrer Verwendung. Aluminiumrahmen, speziell ausgewählte LED-Dioden, Reflektor und Streulichtdiffusor sind nur einige der Vorteile der Kanlux BRAVO LED-Panels. Ein weiterer Vorteil dieser Panels ist die hohe Lichtausbeute (120 lm/W). Da wir uns der Qualität sicher sind, gewähren wir 5 Jahre Garantie auf die Panels. Kanlux BRAVO LED-Panels werden ohne Netzteil geliefert.

5 Jahre Garantie gemäß den Bedingungen der Garantieerklärung, die auf der Website verfügbar ist  
Kanlux BRAVO LED-Panels werden ohne Netzteil geliefert.

Für den ordnungsgemäßen Betrieb wird ein entsprechendes LED-Netzteil benötigt, das im Angebot von Kanlux erhältlich ist.

Gehäusematerial: Stahl

Abdeckungsmaterial: Kunststoff

Panel-/Rahmenmaterial: Stahl

Kanlux BRAVO panels are specially selected components for even greater satisfaction with their use. Aluminium framework, specially selected LED diodes, reflector and diffuser distracting light are just some of the assets of Kanlux BRAVO LED panels. High luminous efficacy is another asset of these panels. Kanlux BRAVO LED panels do not have any power supply included.

5 years Warranty under the terms of the warranty statement, available on our website

The correct LED power supply available in the KANLUX range is required for proper operation.

Enclosure material: steel

Lampshade material: plastic

Panel/frame material: steel

\*nur für BRAVO PU / only for BRAVO PU



BRAVO S/P GRIP



CLIPS BRAVO S/P



SPN BRAVO S/P



ADTR W, SR; B



PSR 100

	INDEX	BRAVO S/P GRIP		CLIPS BRAVO S/P		SPN BRAVO S/P		ADTR						PSR 100			
		60x60 / 62x62	120x30	60x60 / 62x62	120x30	60x60 / 62x62	120x30	30x60 (SR)	30x60 (W)	30x60 (B)	60x60 (SR)	60x60 (W)	60x60 (B)	120x30 (SR)	120x30 (W)	120x30 (B)	60x60 / 62x62
BRAVO PU36W6060NW W	28002	✓		✓		✓					✓	✓	✓				✓
BRAVO PU28W3060NW W	28551	✓		✓		✓		✓	✓	✓							✓
BRAVO S 40W6060NW W	28010	✓		✓		✓					✓	✓	✓				✓
BRAVO S 40W12030NW W	28022		✓		✓		✓							✓	✓	✓	

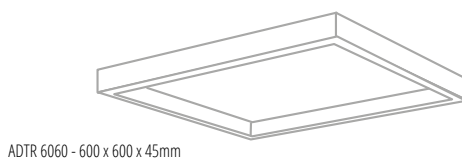

ADTR 6060 - 600 x 600 x 45mm

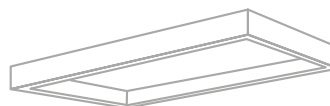

ADTR 3060 - 300 x 600 x 45mm



ADTR 12030 - 1200 x 300 x 45mm

# AVAR LED

LED-BELEUCHTUNGSRAHMEN ► LED LIGHTING FRAME



AVAR 6060 40W-NW



AVAR 6060 40W-CW



AVAR 6262 40W-NW

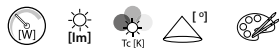

AVAR 6060 40W-NW	<b>26770</b>	5905339267702	40	3600	4000	110	weiß   white
AVAR 6060 40W-CW	<b>26771</b>	5905339267719	40	3800	6000	110	weiß   white
AVAR 6262 40W-NW	<b>26773</b>	5905339267733	40	3600	4000	110	weiß   white
AVAR 6262 40W-WW	<b>26774</b>	5905339267740	40	3400	3000	110	weiß   white

<b>[V]</b> 220-240 AC	<b>[Hz]</b> 50	<b>[h]</b> ≥15000	<b>[h]</b> 25000	<b>[lm]</b> all psc ≤ 60 MacAdam	<b>Ra</b> 80	<b>SMD</b>	<b>IP</b> 20	<b>°</b> 110
<b>[°C]</b> 5+25	<b>[mm]</b> 14	<b>[mm]</b> 0,75	<b>[mm]</b> 0,5m	<b>CE</b>	<b>ERC</b>	<b>UK CA</b>	<b>↓</b>	<b>↓</b>

ZUBEHÖR ► ACCESSORIES

AVAR DALI SET 40W	<b>28512</b>	5905339285126	Set mit Zubehör und Netzteil für die Kommunikation gemäß DALI-Protokoll (28512)   Set containing accessories and a power supply unit enabling communication in line with DALI protocol (28512)				
-------------------	--------------	---------------	--	--	--	--	--



LED-BELEUCHTUNGSRAHMEN sind ein sehr beliebtes Beleuchtungselement für Büroanlagen. Sie haben die Rasterleuchten aufgrund ihrer Langlebigkeit, Energieeffizienz und Ästhetik weitgehend ersetzt. Kanlux AVAR LED ist eine neue Dimension für LED-Rahmen, deren Maßstab nicht nur die moderne Technologie ist, sondern auch die Rahmenform selbst, die starkes und effektives Licht gewährleistet.

AVAR 62x62 ist für die alternative Größe von Deckensystemen (625 mm x 625 mm) vorgesehen.

Gehäusematerial: Aluminiumlegierung

Abdeckungsmaterial: Kunststoff

Panel-/Rahmenmaterial: Aluminiumlegierung

LED panels are very popular lighting elements in office interiors. Due to their durability, energy efficiency and aesthetics, they have replaced extent raster luminaires to a large. Kanlux AVAR LED is a new dimension in LED panels distinguished by modern technology and the shape of frame which emits intense and impressive light.

AVAR 62x62 is intended for an alternative size of ceiling systems (625mmx625mm)

Enclosure material: aluminum alloy

Lampshade material: plastic

Panel/frame material: aluminum alloy

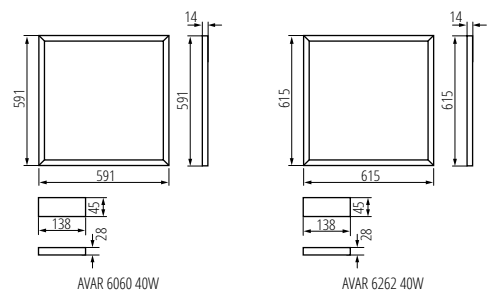





# Kanlux REGIS

EINBAU-RASTERLEUCHTE ▶ EMBEDDED LOUVER FITTING



REGIS 3 EVG 418 PT, REGIS 3WS EVG 418 PT

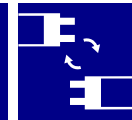

Kanlux REGIS sind Unterputz-Rasterleuchten, die dank Federhaken und Schnellverbinder einfach und schnell zu montieren sind. Raster sind nach wie vor eine sehr beliebte Beleuchtungslösung für Büroräume oder Industrieanlagen.

semi-parabolischer Reflektor / Raster-Querleisten V-förmig / Leuchtstofflampenfassungen, die durch einen Reflektor verdeckt sind (ausgenommen Version REGIS 3 OPAL, REGIS 3WS OPAL mit einer Opal-Platte)

Löcher im Gehäuse für eine einfache Durchgangs-Stromversorgung

Schutzdraht am Raster, der zusätzlich vor Stromschlag schützt, ausgenommen Version REGIS 3 OPAL, REGIS 3WS OPAL.

Öffnungen Rastermontage an Federhaken

Öffnungen im Gehäuse für eine einfache Durchgangs-Stromversorgung, Vorschaltgerät der Marke OSRAM in Klasse A2

Pulverbeschichtung

REGIS 3WS sind mit „WarmStart“-Vorschaltgerät ausgestattet

Gehäusematerial: Stahl

Reflektormaterial: Aluminiumlegierung

Kanlux REGIS are raster recessed luminaires that can be mounted quickly and easily with spring clips and quick couplings. Raster lighting is still a very popular solution for office and industrial spaces.

reflector in the shape of a half-parabola / raster crossbars in the shape of "V" / sockets of fluorescent lamps masked with a reflector (exception: version REGIS 3 OPAL, REGIS 3WS OPAL with an opal board)

the casing contains openings facilitating straight through type power supply

protective cable on a raster, additionally securing against electric shock, except the version REGIS 3 OPAL, REGIS 3WS OPAL.

simple assembly of the raster on spring catches

quick coupling, for connection of power supply, facilitates and accelerates assembly, stabilizer by OSRAM in A2 class

powder coating

REGIS 3WS equipped with a stabilizer with "warm start".

Enclosure material: steel

Reflector material: aluminum alloy



REGIS 3WS EVG 418 PT



REGIS 3WS OPAL 418 PT



REGIS 3 EVG 418 PT	<b>19730</b>	5905339197306	4 x 18	T8	G13	20	weiß   white
REGIS 3 OPAL 418 PT	<b>19734</b>	5905339197344	4 x 18	T8	G13	40	weiß   white
REGIS 3WS EVG 418 PT	<b>25710</b>	5905339257109	4 x 18	T8	G13	20	weiß   white
REGIS 3WS OPAL 418 PT	<b>25713</b>	5905339257130	4 x 18	T8	G13	40	weiß   white

<b>[V]</b> 220-240 AC	<b>[Hz]</b> 50				 5+25		
 1+2,5	 EVG BALLAST	 0,5m					

## ZUBEHÖR ▶ ACCESSORIES

CLP-REGIS\PT	<b>72333</b>	5905339723338	CLP-REGIS\PT-Montagekonsole zum Einbau von Leuchten in eine abgehängte Decke aus Gipskarton. 4 Stück im Lieferumfang enthalten.   CLP-REGIS\PT mounting support, used for building in fittings in a plasterboard suspended ceiling. 4 pcs. in a set.
--------------	--------------	---------------	--

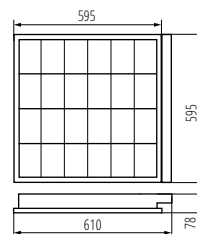

REGIS 3 EVG 418 PT; REGIS 3WS EVG 418 PT

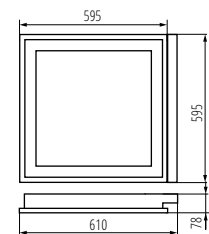

REGIS 3 OPAL 418 PT; REGIS 3WS OPAL 418 PT

# REGIS 4LED

EINBAU-RASTERLEUCHE ▶ EMBEDDED LOUVER FITTING



REGIS 4LED 418 PT



REGIS 4LED OPAL 418PT



REGIS 4LED 418 PT



REGIS 4LED OPAL 418PT	<b>19736</b>	5905339197368	4 x max 18	T8 LED	G13	weiß   white
REGIS 4LED 418 PT	<b>22673</b>	5905339226730	4 x max 18	T8 LED	G13	weiß   white

<b>[V]</b> 220-240 AC	<b>[Hz]</b> 50	ONE SIDE INPUT		IP 20		5±25
		1+2,5	0,5m			

ZUBEHÖR ▶ ACCESSORIES

CLP-REGIS\PT	<b>72333</b>	5905339723338	CLP-REGIS\PT-Montagekonsole zum Einbau von Leuchten in eine abgehängte Decke aus Gipskarton. 4 Stück im Lieferumfang enthalten.   CLP-REGIS\PT mounting support, used for building in fittings in a plasterboard suspended ceiling. 4 pcs. in a set.
--------------	--------------	---------------	--

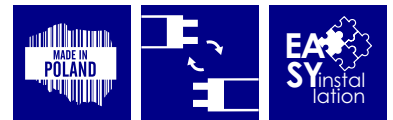

Kanlux REGIS 4LED-Leuchten sind herkömmliche Unterputzleuchten für T8-LED-Leuchtstoffröhren. Sie werden in Polen aus Komponenten polnischer Zulieferer hergestellt. Raster sind nach wie vor eine sehr beliebte Beleuchtungslösung für Büroräume oder Industrieanlagen.

Die Leuchten sind für Leuchtstoffröhren T8 LED 220-240 V ~ ausgelegt; 50/60Hz mit einseitiger Stromversorgung

Leuchten per Aufhängung montierbar

Einfache Montage des Rasters an Federhaken

Pulverbeschichtet

Gehäusematerial: Stahl

Kanlux REGIS 4LED luminaires are traditional raster recessed luminaires adapted to T8 LED fluorescent lamps. They are manufactured in Poland of components provided by Polish suppliers. Raster lighting is still a very popular solution for office and industrial spaces.

the fittings are intended for light sources T8 LED 220-240 V ~; 50/60Hz with one-sided power supply

fittings adapted to suspension on slings

simple assembly of the raster on spring catches

powder coated

Enclosure material: steel

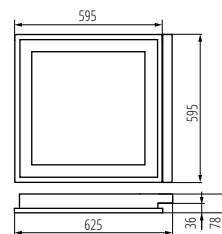

REGIS 4LED OPAL 418PT

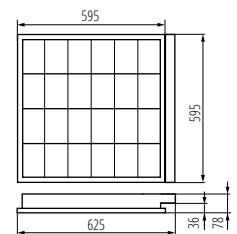

REGIS 4LED 418 PT

# Kanlux NOTUS

AUFBAU-RASTERLEUCHE ▶ CEILING LOUVER FITTING



NOTUS 3 EVG 418 NT



NOTUS 3 EVG 236 NT



NOTUS 3 EVG 218 NT



NOTUS 3 EVG 418 NT	<b>19731</b>	5905339197313	4 x 18	T8	G13	weiß   white
NOTUS 3 EVG 236 NT	<b>19732</b>	5905339197320	2 x 36	T8	G13	weiß   white
NOTUS 3 EVG 218 NT	<b>19733</b>	5905339197337	2 x 18	T8	G13	weiß   white
NOTUS 3WS EVG 418 NT	<b>25711</b>	5905339257116	4 x 18	T8	G13	weiß   white
NOTUS 3WS EVG 236 NT	<b>25712</b>	5905339257123	2 x 36	T8	G13	weiß   white

<b>[V]</b> 220-240 AC	<b>[Hz]</b> 50			<b>IP</b> 20		 5+25	
	 1+2,5	<b>EVG</b> BALLAST	 0,5m	<b>CE</b>	<b>EAC</b>	<b>UK</b> <b>CA</b>	

## ZUBEHÖR ▶ ACCESSORIES

ROPE-NT 150	<b>07870</b>	5905339078704	ROPE-NT 150 Stahlseil (doppelt) zum Aufhängen von Leuchten, 2 Stück im Lieferumfang enthalten   ROPE-NT 150 steel rope (double) for suspending fittings, 2 pcs. in a set
ROPE-NT 150 SINGLE	<b>07871</b>	5905339078711	ROPE-NT 150 Stahlseil (einfach) zum Aufhängen von Leuchten, 2 Stück im Lieferumfang enthalten   ROPE-NT 150 SINGLE steel rope (single) for suspending fittings, 2 pcs. in a set

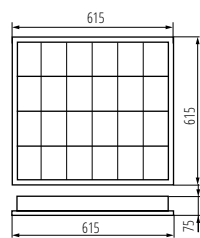

NOTUS 3 EVG 418; NOTUS 3WS EVG 418

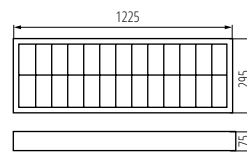

NOTUS 3 EVG 236; NOTUS 3WS EVG 236

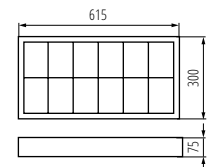

NOTUS 3 EVG 218 NT



Kanlux NOTUS sind Aufputz-Rasterleuchten, die sich durch einfache und schnelle Montage auszeichnen. Raster sind nach wie vor eine sehr beliebte Beleuchtungslösung für Büroräume oder Industrieanlagen. Der Grund dafür sind die guten Beleuchtungsparameter zu einem guten Preis, der einfache Aufbau und die Beständigkeit der Materialien, aus denen sie hergestellt sind.

Halbparabolischer Reflektor / „V“-förmiger Querbalke des Rasters

Der Sitz der Leuchtstofflampe wird durch den Reflektor verdeckt

Leuchten per Aufhängung montierbar

Vorschaltgeräte TRIDONIC der Klasse A2

Einfache Montage des Rasters mit Federösen

Schnellanschluss für Zuleitung, der den Einbau erleichtert und beschleunigt  
Pulverbeschichtung

NOTUS 3WS sind mit „WarmStart“- Vorschaltgerät ausgestattet

Gehäusematerial: Stahl

Reflektormaterial: Aluminiumlegierung

Kanlux NOTUS are raster facade luminaires that can be mounted quickly and easily. Raster lighting is still a very popular solution for office and industrial spaces. It is all due to good lighting parameters at a good price, simple construction and durability of the materials of which they are made.

half-parabolic reflector / V-shaped grille cross-bars

fluorescent lamp sockets concealed with a reflector

light fixtures designed for hanging on slings

Class A2 OSRAM ballast

easy installation of the grille on spring hooks

quick coupling for connecting the power supply, easier and quicker installation, powder coating

NOTUS 3WS equipped with a „warm start“ ballast

Enclosure material: steel

Reflector material: aluminum alloy

# NOTUS 4LED

AUFBAU-RASTERLEUCHE ▶ CEILING LOUVER FITTING



NOTUS 4LED 418 NT



NOTUS 4LED 236 NT



NOTUS 4LED 218 NT



NOTUS 4LED 418 NT	<b>22671</b>	5905339226716	4 x max 18	T8 LED	G13	weiß   white
NOTUS 4LED 236 NT	<b>22672</b>	5905339226723	2 x max 36	T8 LED	G13	weiß   white
NOTUS 4LED 218 NT	<b>22674</b>	5905339226747	2x max 18	T8 LED	G13	weiß   white

<b>[V]</b> 220-240 AC	<b>[Hz]</b> 50	<b>ONE SIDE INPUT</b>	<b>IP</b> 20	<b>CE</b>	<b>ERAC</b>	<b>UK</b>	<b>5+25</b>

ZUBEHÖR ▶ ACCESSORIES

ROPE-NT 150	<b>07870</b>	5905339078704	ROPE-NT 150 Stahlseil (doppelt) zum Aufhängen von Leuchten, 2 Stück im Lieferumfang enthalten   ROPE-NT 150 steel rope (double) for suspending fittings, 2 pcs. in a set
ROPE-NT 150 SINGLE	<b>07871</b>	5905339078711	ROPE-NT 150 Stahlseil (einfach) zum Aufhängen von Leuchten, 2 Stück im Lieferumfang enthalten   ROPE-NT 150 SINGLE steel rope (single) for suspending fittings, 2 pcs. in a set

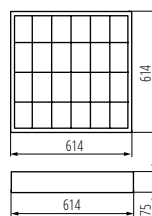

NOTUS 4LED 418 NT

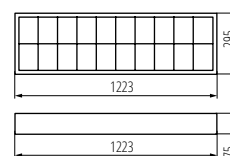

NOTUS 4LED 236 NT

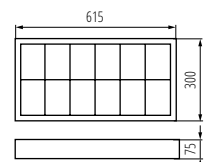

NOTUS 4LED 218 NT

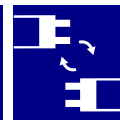

Kanlux NOTUS 4LED sind herkömmliche Aufputz-Rasterleuchten für T8-LED-Leuchtstoffröhren. Sie werden in Polen aus Komponenten polnischer Zulieferer hergestellt. Die Rasterleuchte ist eine Beleuchtungslösung für Büro und Industrieanlagen. LED-Leuchtstoffröhren tragen zusätzlich zu einem geringeren Energieverbrauch bei.

Die Leuchten sind für Leuchtstoffröhren T8 LED 220-240 V - ausgelegt; 50/60Hz mit einseitiger Stromversorgung  
 Halbparabolischer Reflektor / „V“-förmiger Querbalken des Rasters  
 Der Sitz der Leuchtstofflampe wird durch den Reflektor verdeckt  
 Leuchten per Aufhängung montierbar  
 Einfache Montage des Rasters mit Federösen  
 Pulverbeschichtet  
 Gehäusematerial: Stahl  
 Reflektormaterial: Aluminiumlegierung

Kanlux NOTUS 4LED luminaires are façade raster luminaires adapted to T8 LED fluorescent lamps. They are manufactured in Poland of components provided by Polish suppliers. Raster lighting is a solution for office and industrial interiors. Additionally, LED fluorescent lamps contribute to lower energy consumption.

the fittings are intended for sources T8 LED 220-240 V-; 50/60 Hz with one-sided power supply  
 half-parabolic reflector / V-shaped grille cross-bars  
 fluorescent lamp sockets concealed with a reflector  
 light fixtures designed for hanging on slings  
 easy installation of the grille on spring hooks  
 powder coating  
 Enclosure material: steel  
 Reflector material: aluminum alloy

# TP STRONG

LED-LANGFELBLEUCHE ▶ LINEAR LED LUMINAIRE



TP STRONG LED 48W-NW



TP STRONG LED 75W-NW



TP STRONG LED 90W-NW



Kanlux TP STRONG ist eine hermetische Leuchte für besondere Zwecke. Schutzart IP65, der Widerstand IK08 und 135lm/W - das sind die Hauptvorteile dieser Leuchte. Darüber hinaus beträgt der Abstrahlwinkel 120°. Die Parameter sprechen für sich und wir gewähren 5 Jahre Garantie.

5 Jahre Garantie gemäß den Bedingungen der Garantieerklärung, die auf der Website verfügbar ist

Gehäusematerial: Kunststoff  
Abdeckungsmaterial: PC

Kanlux TP STRONG is a hermetic luminaire for special purposes. The tightness of IP65, mechanical resistance of IK08, and luminous efficacy of 135lm/W are the main advantages of this luminaire. Additionally, it has a light distribution angle of X125°/Y110°. The parameters speak for themselves, but we also give a 5-year warranty.

5 years Warranty under the terms of the warranty statement, available on our website

Enclosure material: plastic  
Lampshade material: PC

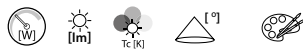

TP STRONG LED 48W-NW	<b>33170</b>	5905339331700	48	6500	4000	X125\Y110	weiß   white
TP STRONG LED 75W-NW	<b>33171</b>	5905339331717	75	10000	4000	X125\Y110	weiß   white
TP STRONG LED 90W-NW	<b>33172</b>	5905339331724	90	12000	4000	X125\Y110	weiß   white

[V] 220-240 AC	[Hz] 50	[lm] ≥30000	[h] 50000	ellipse ≤ für Nachlampe	Ra 80	SMD	IP 65	°C -20+40
IK 08	1,5+2,5	0,5m	CE	ERC	PZH	UK CA		

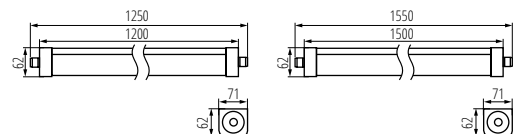

TP STRONG LED 48W

TP STRONG LED 75W; 90W

# TP SLIM LED

LED-LANGFELDLEUCHTE ► LINEAR LED LUMINAIRE



TP SLIM LED 50W



TP SLIM LED 40W-NW



TP SLIM TW LED

Kanlux TP SLIM TW LED- Durchgangsverdrahtete Leuchte, 2 Steckklemmen in der Leuchte, Möglichkeit der Durchgangsverdrahtung der Leuchten.  
 Kanlux TP SLIM TW LED- fitting with pass-through installation, 2 chokes in the fitting, possibility of connecting the fittings in-line.

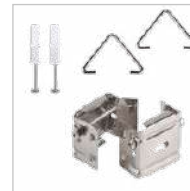

LED  
technology

IP  
65

up to

110 lm/W

EASY  
installation

Kanlux TP SLIM LED ist eine kleine hermetische Leuchte, die sowohl für den Anbau als auch für die Pendelmontage geeignet ist. Dank verstellbarer Halterungen und Schnellkupplungen ist die Montage einfach und schnell. Die hohe Schutzart IP65 und der Widerstand IK08 gegen Aufprall, ermöglichen die Montage an Orten, die direkten Witterung ausgesetzt sind. Staubsichte Leuchten Kanlux TP SLIM LED eignen sich hervorragend zur Beleuchtung von Tunneln, Industriehallen, Garagen, Werkstatträumen, Lagerüberdachungen oder Lagern.

Gehäusematerial: Kunststoff  
 Abdeckungsmaterial: Kunststoff

Kanlux TP SLIM LED is a small hermetic fitting which can be mounted on a surface or in a suspended form. Assembly is convenient thanks to adjustable holders and quick couplings. Owing to IP65 tightness class and IK 08 resistance to impact, you can use the fitting in such places as: industrial rooms, warehouses, car parks and garages.

Enclosure material: plastic  
 Lampshade material: plastic

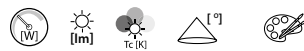

TP SLIM LED 40W-NW	<b>27115</b>	5905339271150	40	4400	4000	X145/Y110	weiß   white
TP SLIM LED 50W-NW	<b>27116</b>	5905339271167	50	5500	4000	X145/Y110	weiß   white
TP SLIM TW LED 40W-NW	<b>27117</b>	5905339271174	40	4400	4000	X145/Y110	weiß   white
TP SLIM TW LED 50W-NW	<b>27118</b>	5905339271181	50	5500	4000	X145/Y110	weiß   white

[V] 220-240 AC	[Hz] 50	[h] ≥20000	[h] 25000	[°] elliptisch ≤ 60° (Maxdäm)	Ra 80	SMD			IP 65	
[°C] -20+40	IK 08		[mm] 1-2,5	[m] 0,5m						

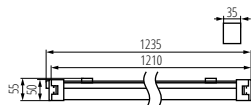

TP SLIM LED 40W-NW

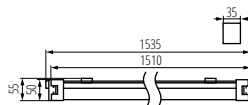

TP SLIM LED 50W-NW

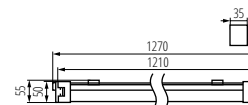

TP SLIM TW LED 40W-NW

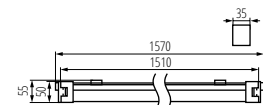

TP SLIM TW LED 50W-NW

# MAH LED HI

LED-FEUCHTRAUM-WANNENLEUCHE ▶ LED DUSTPROOF LIGHTING FITTING



MAH LED HI 19W-NW RYF



**5**  
WARRANTY  
5 years

**IP**  
**65**

up to  
**150** lm  
**W**

Kanlux MAH LED HI sind hermetische Leuchten, entworfen für anspruchsvollere Anwender. Sie zeichnen sich durch eine enorme Lichtausbeute von bis zu 150 lm/W aus. Es besteht die Möglichkeit, die Leuchten in einer Reihe zu verbinden, wodurch große Flächen beleuchtet werden können. Bei den MAH LED HI-Leuchten von Kanlux haben wir einen wellenförmigen Diffusor verwendet, der den Lichtstrom erhöht.

5 Jahre Garantie gemäß den Bedingungen der Garantieerklärung, die auf der Website verfügbar ist

Gehäusematerial: PC

Abdeckungsmaterial: PC

Kanlux MAH LED HI are hermetic luminaires designed for demanding users. They are characterised by exceptional luminous efficacy reaching 150 lm/W. Kanlux MAH LED HI luminaires are easy and quick to mount and can be connected in lines, enabling the illumination of large spaces. In Kanlux MAH LED HI luminaires, we used a grooved lampshade, which increases the luminous flux.

5 years Warranty under the terms of the warranty statement, available on our website

Enclosure material: PC

Lampshade material: PC



MAH LED HI 38W-NW RYF



MAH LED HI 48W-NW RYF



MAH LED HI 26W-NW RYF

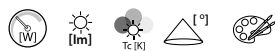

MAH LED HI 19W-NW RYF	<b>22606</b>	5905339226068	19	2400	4000	110	grau   grey
MAH LED HI 38W-NW RYF	<b>22607</b>	5905339226075	38	5000	4000	110	grau   grey
MAH LED HI 48W-NW RYF	<b>22608</b>	5905339226082	48	6400	4000	110	grau   grey
MAH LED HI 26W-NW RYF	<b>22609</b>	5905339226099	26	3900	4000	110	grau   grey

<b>[V]</b> 220-240 AC	<b>[Hz]</b> 50	 ≥15000	 50000	 Ra 80	 SMD	 IP 65	 -20+40
 IK 08	 1,5+2,5	 0,5m					

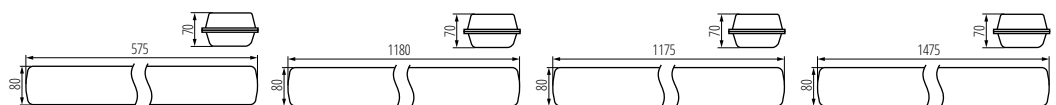

MAH LED HI 19W

MAH LED HI 26W

MAH LED HI 38W

MAH LED HI 48W

# MAH LED N

LED-FEUCHTRAUM-WANNENLEUCHTE ▶ LED DUSTPROOF LIGHTING FITTING



MAH-LED N 20W-NW/PC



MAH-LED N 40W-NW/PC



MAH-LED N 50W-NW/PC



Kanlux MAH LED N sind hermetische Leuchten entworfen für anspruchsvollere Anwender. Sie zeichnen sich durch eine außergewöhnliche Lichtausbeute von bis zu 105 lm/W und die Möglichkeit aus, bis zu 15 Leuchten in einer Reihe (je nach Modell) zu verbinden, wodurch große Flächen beleuchtet werden können.

Gehäusematerial: PC  
Abdeckungsmaterial: PC

Kanlux MAH LED N are hermetic luminaires designed for more demanding users. They are characterised by unique luminous efficacy reaching 105 lm/W and the possibility of connecting them in lines of even 15 luminaires (depending on the model), which allows for lighting of large spaces.

Enclosure material: PC  
Lampshade material: PC



MAH-LED N 20W-NW/PC	<b>22603</b>	5905339226037	20	2100	4000	X135V100	grau   grey
MAH-LED N 40W-NW/PC	<b>22604</b>	5905339226044	40	4200	4000	X135V100	grau   grey
MAH-LED N 50W-NW/PC	<b>22605</b>	5905339226051	50	5250	4000	X135V100	grau   grey

[V]	[Hz]	Hand icon	(h)	Circle with plus	Ra	SMD	Triangle	IP	House icon	Temperature icon
220-240 AC	50	≥15000	30000	ellipse ≤ 6x MaxKam	80			65		-20+40
Mounting icon	IK 08	Dimensions icon	Dimensions icon	Dimensions icon	CE	EAC	PZH	UK CA	Down arrow icon	
		1,5+2,5	0,5m							

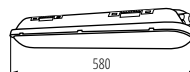

MAH-LED N 20W PC

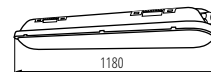

MAH-LED N 40W PC

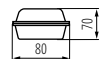
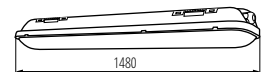

MAH-LED N 50W PC



# MAH PLUS 4LED

FEUCHTRAUM-WANNENLEUCHE  
▶ DUST-PROOF LED TUBE LIGHT FITTING



MAH PLUS-236/4LED/PC



MAH PLUS-136/4LED/PC



MAH PLUS-158/4LED/PC



MAH PLUS-236/4LED/PC	<b>22800</b>	5905339228000	2 x max 36	T8 LED	G13	grau   grey
MAH PLUS-258/4LED/PC	<b>22801</b>	5905339228017	2 x max 58	T8 LED	G13	grau   grey
MAH PLUS-136/4LED/PC	<b>22802</b>	5905339228024	max 36	T8 LED	G13	grau   grey
MAH PLUS-158/4LED/PC	<b>22803</b>	5905339228031	max 58	T8 LED	G13	grau   grey

[V] 220-240 AC	[Hz] 50	IP 65	5+25	1+2,5
ONE SIDE INPUT	0,5m	CE	EAC	PZH
			CSK	

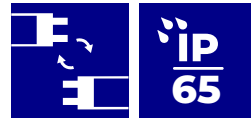

Kanlux MAH PLUS 4LED sind LED-Leuchten als Ersatz zu den bekannten Feuchtraumleuchten. Ihr Hauptvorteil ist die Tatsache, dass T8 LED-Leuchtstoffröhren mit einer Länge von 1200mm oder 1500mm eingesetzt werden können. Es ist eine ausgezeichnete Lösung für industrielle Anwendungen.

Die Leuchten MAH PLUS 4LED/PC sind für Leuchtstoffröhren T8 LED 220-240 V ~ ausgelegt; 50/60 Hz mit einseitiger Versorgung  
Gehäusematerial: Kunststoff  
Abdeckungsmaterial: PC  
Material der Klammer: Kunststoff

Kanlux MAH PLUS 4LED are LED equivalents of popular luminaires. Their core asset consists in the fact that they can use T8 LED light sources that are 1200 mm or 1500 mm long. This solution is perfect for industrial use.

MAH PLUS 4 LEDs/PC light fixtures are designed for T8 LED 220-240 V-; 50/60 Hz light sources with one-sided power supply  
Enclosure material: plastic  
Lampshade material: PC  
Clasp material: plastic

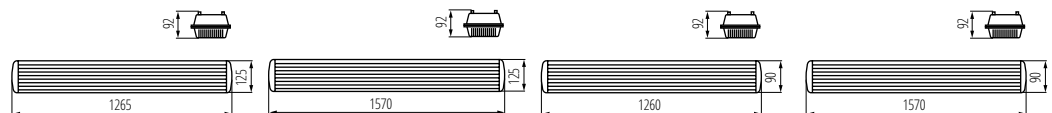

MAH PLUS-236/4LED/PC

MAH PLUS-258/4LED/PC

MAH PLUS-136/4LED/PC

MAH PLUS-158/4LED/PC

# Kanlux MAH PLUS

FEUCHTRAUM-WANNENLEUCHTE ► DUSTPROOF LIGHTING FITTING



MAH PLUS-236-ABS/PC



MAH PLUS-236-ABS/PC | **18521** | 5905339185211 | 2 x 36 | T8 | G13 | grau | grey

<b>[V]</b> 220-240 AC	<b>[Hz]</b> 50			<b>IP</b> 65		 5+25		
 1+2,5		 0,5m						

## ZUBEHÖR ► ACCESSORIES

CL-MAH PLUS	<b>18593</b>	5905339185938	Leuchten-Clip MAH, CL-MAH PLUS, (18593)   Fitting clip MAH, CL-MAH PLUS, (18593)
CL-MAH PLUS-INOX	<b>18594</b>	5905339185945	Leuchten-Clip MAH, CL-MAH PLUS-INOX, (18594)   Fitting clip MAH, CL-MAH PLUS-INOX, (18594)
ROPE-NT 150	<b>07870</b>	5905339078704	ROPE-NT 150 Stahlseil (doppelt) zum Aufhängen von Leuchten, 2 Stück im Lieferumfang enthalten   ROPE-NT 150 steel rope (double) for suspending fittings, 2 pcs. in a set
ROPE-NT 150 SINGLE	<b>07871</b>	5905339078711	ROPE-NT 150 Stahlseil (einfach) zum Aufhängen von Leuchten, 2 Stück im Lieferumfang enthalten   ROPE-NT 150 SINGLE steel rope (single) for suspending fittings, 2 pcs. in a set



Staubdichte Leuchten Kanlux MAH PLUS eignen sich hervorragend zur Beleuchtung von Tunneln, Industriehallen, Garagen, Werkstatträumen, Lagerüberdachungen oder Lagern. Die hohe Schutzart IP65 ermöglicht die Montage an Orten, die direkt der Witterung ausgesetzt sind.

Einfache Montage der Leuchte mithilfe der beigefügten Rasthalter  
Aufhänge-Montageplatte für einfachen Anschluss und Wartung der Leuchte  
Abdichtende Durchführungstülle zum Einführen des Versorgungskabels

Gehäusematerial: Kunststoff  
Abdeckungsmaterial: PC  
Material der Klammer: Kunststoff  
Material des Griffes: Metall

Kanlux MAH PLUS are perfect as lighting of tunnels, industrial halls, garages, workshops, storage sheds or storehouses. Owing to the high class of tightness (IP65), the luminaires can be mounted in places directly exposed to weather conditions.

easy installation of the light fixture using the supplied snap-on mounting brackets  
suspended mounting plate for easier connection and maintenance of the light fixture  
barrier gland for inserting a power cable  
Enclosure material: plastic  
Lampshade material: PC  
Clasp material: plastic  
Handle material: Metal

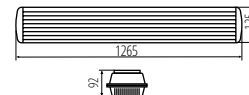

MAH PLUS-236-ABS/PC



# MEBA LED IP54

LED-LANGFELDLEUCHE ▶ LINEAR LED LUMINAIRE



MEBA LED 20W IP54 NW



WARRANTY  
5 years

LED  
technology

HIGH  
efficacy

IP  
54

Kanlux MEBA LED IP54 ist eine Serie von Aufbauleuchten die die beliebte Familie der Kanlux MEBA-Leuchten ergänzt. Wir können aus Modellen mit einer Länge von 600mm und 1200mm wählen. Kanlux MEBA LED IP54 steht für hohe Lichtausbeute, Lebensdauer von 50.000 Stunden und eine Garantie von 5 Jahren. Ein zusätzlicher Vorteil dieser Leuchten ist die Schutzart IP54 und zwei Kabeleinführungen, die eine Durchgangsverdrahtung ermöglichen. Die Anschlussklemme erleichtert den Anschluss der Leuchte. Der Lampenschirm und die Seiten der Leuchte sind aus Polycarbonat, und das Gehäuse ist aus Stahlblech gefertigt. Dies sind weitere Vorteile dieser Leuchten.

5 Jahre Garantie gemäß den Bedingungen der Garantieerklärung, die auf der Website verfügbar ist  
Gehäusematerial: Stahl  
Abdeckungsmaterial: PC

Kanlux MEBA LED IP54 is a series of surface-mounted luminaires that complements the popular family of Kanlux MEBA luminaires. We can choose from models with a length of 600mm and 1200mm. Kanlux MEBA LED IP54 means high luminous efficiency, durability of 50,000 hours and a 5-year warranty. An additional advantage of these luminaires is the IP54 level and two cable entries that allow for pass-through connection. The quick connector makes it easier to install the luminaire, and the lampshade and sides of the luminaire are made of polycarbonate and the body is made of steel sheet. These are other advantages of these luminaires.

5 years Warranty under the terms of the warranty statement, available on our website  
Enclosure material: steel  
Lampshade material: PC

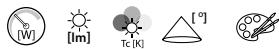

MEBA LED 20W IP54 NW	<b>33892</b>	5905339338921	20	2600	4000	120	weiß   white
MEBA LED 40W IP54 NW	<b>33893</b>	5905339338938	40	5200	4000	120	weiß   white

[V] 220-240 AC	[Hz] 50	[lm] ≥25000	[h] 50000	[lm] [m] ≤ 60 Max/Adam	[Ra] 80	[SMD]
[°] 0,75-2	[m] 0,5m	IP 54	[°C] -20+40	[UK CA]	[EAC]	[UK CA]

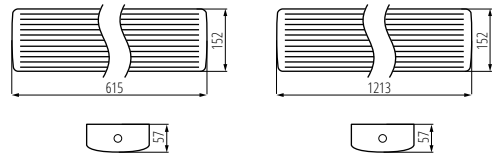

MEBA LED 20W IP54 NW

MEBA LED 40W IP54 NW

# MEBA 4LED IP54

LED-LANGFELDLEUCHE ▶ LINEAR LED LUMINAIRE



MEBA 4LED 60 IP54 PC

WARRANTY  
5 years

IP  
54

Kanlux MEBA 4LED IP54 ist eine Serie von Aufbauleuchten mit einem austauschbaren Leuchtmittel, die die beliebte Familie der Kanlux MEBA-Leuchten ergänzt. Wir können aus Modellen mit Längen von 600mm, 1200mm und 1500mm wählen. Kanlux MEBA 4LED IP54 hat eine 5-jährige Garantie und eine Dichtigkeit von IP54. Zwei Kabeleinführungen ermöglichen die Durchgangsverdrahtung der Leuchten. Die Anschlussklemme erleichtert die Installation der Leuchte, der Lampenschirm und die Seiten der Leuchte sind aus Polycarbonat, das Gehäuse ist aus Stahlblech - das sind weitere Vorteile der Kanlux MEBA 4LED IP54-Leuchten.

5 Jahre Garantie gemäß den Bedingungen der Garantieerklärung, die auf der Website verfügbar ist  
die Leuchten sind für Leuchtmittel T8 LED 220-240 V-; 50/60 Hz mit einseitiger Stromzufuhr bestimmt  
Gehäusematerial: Stahl  
Abdeckungsmaterial: PC

Kanlux MEBA 4LED IP54 is a series of surface-mounted luminaires with a replaceable light source, which complements the popular family of Kanlux MEBA luminaires. We can choose from models with lengths of 600mm, 1200mm and 1500mm. Kanlux MEBA 4LED IP54 has a 5-year warranty and a tightness level of IP54. Two cable entries allow for pass-through connection of the luminaires. The quick connector makes it easier to install the fixture, and the lampshade and sides of the fixture are made of polycarbonate and the body is made of steel sheet - these are other advantages of the Kanlux MEBA 4LED IP54 lamps.

5 years Warranty under the terms of the warranty statement, available on our website  
the fittings are intended for sources T8 LED 220-240 V-; 50/60 Hz with one-sided power supply  
Enclosure material: steel  
Lampshade material: PC



MEBA 4LED 60 IP54 PC	<b>33894</b>	5905339338945	2 x max 9	T8 LED	G13	weiß   white
MEBA 4LED 120 IP54 PC	<b>33895</b>	5905339338952	2 x max 18	T8 LED	G13	weiß   white
MEBA 4LED 150 IP54 PC	<b>33896</b>	5905339338969	2 x max 24	T8 LED	G13	weiß   white

[V] 220-240 AC	[Hz] 50	[lm] ONE SIDE INPUT	[h] 50000	[°C] -20+40	[UK CA]	[EAC]
[m] 0,75-2	[m] 0,5m	IP 54	[UK CA]	[EAC]	[UK CA]	[EAC]

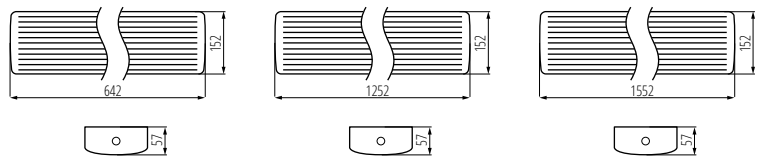

MEBA 4LED 60 IP54 PC

MEBA 4LED 120 IP54 PC

MEBA 4LED 150 IP54 PC

# Kanlux MEBA LED

LED-LANGFELBLEUCHTE ► LINEAR LED LUMINAIRE



MEBA LED 22-40W NW/WW



5  
WARRANTY  
5 years

LED  
technology

4 in 1

up to  
125 lm/W

Kanlux MEBA LED ist eine Serie von Aufbauleuchten, die die beliebte Familie der Kanlux MEBA-Leuchten ergänzt. Wir haben eine Auswahl an Modellen mit einer Länge von 610mm (12/20W) und 1200mm (22/40W) zur Auswahl, die jeweils über zwei Leistungsoptionen und zwei Lichtfarbenoptionen (3000/4000K) in einem Gehäuse verfügen. Kanlux MEBA LED bedeutet hohe Lichtausbeute (bis zu 125lm/W), eine Lebensdauer von 50.000 Stunden und eine 5-jährige Garantie. Ein zusätzlicher Vorteil dieser Leuchten ist ein haltbarer, geriffelter PC-Diffusor.

5 Jahre Garantie gemäß den Bedingungen der Garantierklärung, die auf der Website verfügbar ist  
Gehäusematerial: Stahl  
Abdeckungsmaterial: PC

Kanlux MEBA LED is a series of surface-mounted luminaires that complement the popular family of Kanlux MEBA luminaires. We have a choice of models with a length of 610mm (12 / 20W) and 1200mm (22 / 40W), each of them has two power options and two light colors options (3000 / 4000K) in one housing. Kanlux MEBA LED means high luminous efficiency (up to 125lm / W), durability of 50,000 hours and a 5-year warranty. An additional advantage of these luminaires is a durable, grooved PC diffuser.

5 years Warranty under the terms of the warranty statement, available on our website  
Enclosure material: steel  
Lampshade material: PC

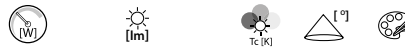

MEBA LED 12-20W NW/WW	<b>33890</b>	5905339338907	12\20	1350(WW) 1500(NW) \ 2200(WW) 2300(NW)	3000\4000	120	weiß   white
MEBA LED 22-40W NW/WW	<b>33891</b>	5905339338914	22\40	2500(WW) 2700(NW) \ 4200(WW) 4400(NW)	3000\4000	120	weiß   white

<b>[V]</b> 220-240 AC	<b>[Hz]</b> 50	≥30000	50000	ellipse ≤ 6x MacAdam	Ra 80	SMD			<b>IP</b> 20	
5+25			0,75-2	0,5m						

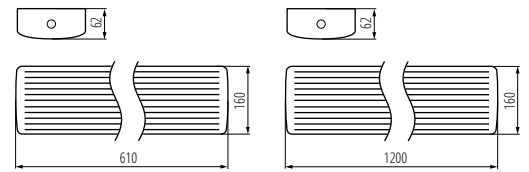

MEBA LED 12-20W NW/WW

MEBA LED 22-40W NW/WW

# Kanlux MEBA 4LED

LANGFELBLEUCHTE T8/LED ► T8 LED TUBE LINEAR FITTINGS



MEBA 4LED 2X120 PS



Kanlux MEBA 4LED ist eine LED-Version der Kanlux MEBA-Langfeldleuchte. Da für T8-LED-Leuchtmittel vorgesehen, garantieren sie einen sparsameren und längeren Betrieb, was sich positiv in ihrem Nutzungskomfort in Schönheitssalons, Friseursalons und Büroräumen niederschlägt.

Gehäusematerial: Kunststoff, Stahl  
Abdeckungsmaterial: PS

Kanlux MEBA 4LED is a LED version of Kanlux MEBA linear luminaire. T8 LED tubes used in it guarantee more economical and longer operation, which positively translates into the comfort of use in beauty and hairdresser salons, and office spaces.

the fittings are intended for sources T8 LED 220-240 V-, 50/60 Hz with one-sided power supply  
Enclosure material: plastic, steel  
Lampshade material: PS



MEBA 4LED 2X120 PS	<b>26961</b>	5905339269614	2 x max 36	T8 LED	G13	weiß   white
MEBA 4LED 2X120 OP PS	<b>26964</b>	5905339269645	2 x max 36	T8 LED	G13	weiß   white
MEBA 4LED 2X150 OP PS	<b>26965</b>	5905339269652	2 x max 58	T8 LED	G13	weiß   white

<b>[V]</b> 220-240 AC	<b>[Hz]</b> 50			<b>IP</b> 20		5+25	
	1-2,5	ONE SIDE INPUT	0,5m				

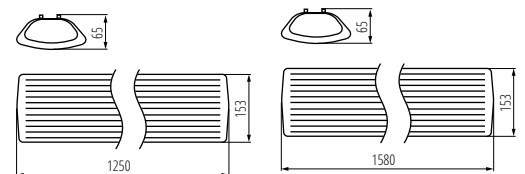

MEBA 4LED 2X120

MEBA 4LED 2X150

# ALDO 4LED

LANGFELDLEUCHE T8/LED ▶ T8 LED TUBE LINEAR FITTINGS



ALDO 4LED 1X60; 1X120; 1X150



ALDO 4LED 1X120



ALDO 4LED 1X150



ALDO 4LED 2X120



ALDO 4LED 1X60	<b>26360</b>	5905339263605	max 18	T8 LED	G13	weiß   white
ALDO 4LED 1X120	<b>26361</b>	5905339263612	max 36	T8 LED	G13	weiß   white
ALDO 4LED 1X150	<b>26362</b>	5905339263629	max 58	T8 LED	G13	weiß   white
ALDO 4LED 2X120	<b>26364</b>	5905339263643	2 x max 36	T8 LED	G13	weiß   white
ALDO 4LED 2X150	<b>26365</b>	5905339263650	2 x max 58	T8 LED	G13	weiß   white

<b>[V]</b> 220-240 AC	<b>[Hz]</b> 50			<b>IP</b> 20		 5÷25	
	 0,5-2,5	 L N ONE SIDE INPUT	 0,5m	<b>CE</b>	<b>ERC</b>	<b>UK CA</b>	

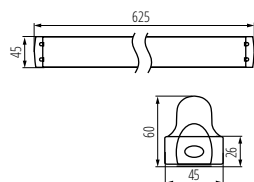

ALDO 4LED 1X60

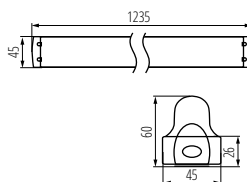

ALDO 4LED 1X120

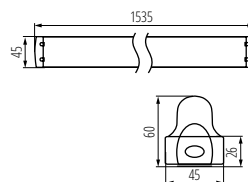

ALDO 4LED 1X150

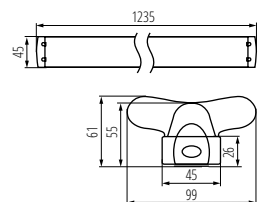

ALDO 4LED 2X120; 2X120R

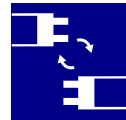

Kanlux ALDO 4LED ist eine Serie von Linienleuchten für T8 LED-Leuchtstoffröhren. Hierbei handelt es sich um Wand- und Deckenleuchten, die sich durch eine moderne, aerodynamische Form auszeichnen und sich dezent in jede Raumgestaltung einfügen.

Die Leuchten sind für Leuchtstoffröhren T8 LED 220-240 V- ausgelegt; 50/60 Hz mit einseitiger Einspeisung.

ALDO R mit Reflektor

Gehäusematerial: Metall, Kunststoff

Kanlux ALDO 4LED are a family of batten luminaires adapted to T8 LED fluorescent lamps. They are wall and ceiling luminaires characterised by modern, streamlined shape so they fit discreetly in each interior arrangement.

The fittings are intended for sources T8 LED 220-240 V-; 50/60 Hz with one-sided power supply

Enclosure material: Metal, plastic

# ALDO 4LED

LANGFELDLEUCHE T8/LED ▶ T8 LED TUBE LINEAR FITTINGS

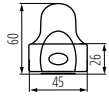
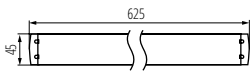

ALDO 4LED 1X60

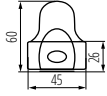
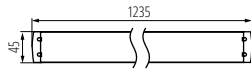

ALDO 4LED 1X120

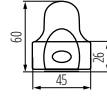
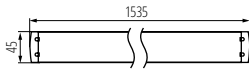

ALDO 4LED 1X150

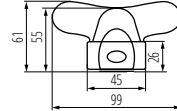
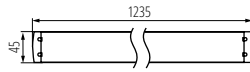

ALDO 4LED 2X120

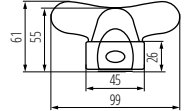
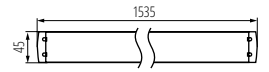

ALDO 4LED 2X150



# IPER LED

LED- DECKENLEUCHTE ▶ CEILING-MOUNTED LED LIGHT FITTING



IPER LED 10W-NW-O



IPER LED 10W-NW-O	<b>37290</b>	5905339372901	10	1200	4000	weiß   white		
IPER LED 19W-NW-O	<b>37291</b>	5905339372918	19	2280	4000	weiß   white		
IPER LED 26W-NW-O	<b>37292</b>	5905339372925	26	3120	4000	weiß   white		
IPER LED 35W-NW-O	<b>37293</b>	5905339372932	35	4200	4000	weiß   white		
IPER LED 10W-NW-L	<b>37294</b>	5905339372949	10	1200	4000	weiß   white		
IPER LED 19W-NW-L	<b>37295</b>	5905339372956	19	2280	4000	weiß   white		
IPER LED 26W-NW-L	<b>37296</b>	5905339372963	26	3120	4000	weiß   white		
IPER LED 35W-NW-L	<b>37297</b>	5905339372970	35	4200	4000	weiß   white		
IPER LED 10W-NW-O-SE	<b>37298</b>	5905339372987	10	1200	4000	weiß   white	Mikrowellen-	microwave
IPER LED 19W-NW-O-SE	<b>37299</b>	5905339372994	19	2280	4000	weiß   white	Mikrowellen-	microwave
IPER LED 26W-NW-O-SE	<b>37300</b>	5905339373007	26	3120	4000	weiß   white	Mikrowellen-	microwave
IPER LED 35W-NW-O-SE	<b>37301</b>	5905339373014	35	4200	4000	weiß   white	Mikrowellen-	microwave
IPER LED 10W-NW-L-SE	<b>37302</b>	5905339373021	10	1200	4000	weiß   white	Mikrowellen-	microwave
IPER LED 19W-NW-L-SE	<b>37303</b>	5905339373038	19	2280	4000	weiß   white	Mikrowellen-	microwave
IPER LED 26W-NW-L-SE	<b>37304</b>	5905339373045	26	3120	4000	weiß   white	Mikrowellen-	microwave
IPER LED 35W-NW-L-SE	<b>37305</b>	5905339373052	35	4200	4000	weiß   white	Mikrowellen-	microwave

[V]	[Hz]	[°]	[h]	[h]	ellipse	Ra
220-240 AC	50	120	≥50000	50000	≤ 6° MacKadm	80
Hg	SMD			IP		°C
				65		-20+40
	IK			CE	EAC	
	10					
UK						
CA						



Die LED-Deckenleuchte Kanlux IPER hat eine Reihe von Vorteilen, die ihre Qualität beeinflussen. 5 Jahre Garantie, Lebensdauer von 50.000 Stunden, hohe Lichtausbeute von 120lm/W - das sind nur einige davon. Die LED-Deckenleuchten Kanlux IPER basieren auf Komponenten renommierter Hersteller, wie z. B. Samsung 2835 LEDs. Darüber hinaus zeichnen sich diese Leuchten durch eine außergewöhnliche Beständigkeit gegen das Eindringen von Wasser und Staub IP65 und die höchste mechanische Beständigkeit IK10 („vandalensicher“) aus, dank derer Sie diese Deckenleuchte an jedem möglichen Ort im Innen- und Außenbereich einsetzen können. Um sie an jede Situation und jeden Ort anzupassen, können Sie wählen zwischen: zwei Leuchtenformen, vier Leistungsstufen und der Möglichkeit, Leuchten mit Mikrowellen-Bewegungssensor (SE-Modelle).

5 Jahre Garantie gemäß den Bedingungen der Garantieerklärung, die auf der Website verfügbar ist  
Gehäusematerial: Kunststoff  
Abdeckungsmaterial: Kunststoff

The Kanlux IPER LED ceiling fixture has a number of advantages that affect its quality. 5-year warranty, durability 50,000 hours, high luminous efficiency of 120lm/W - these are just some of them. Kanlux IPER LED ceiling lamps are based on components from renowned manufacturers, such as Samsung 2835 LEDs. Moreover, these lamps are characterized by exceptional resistance to the ingress of water and dust IP65 and the highest mechanical resistance IK10 (“vandal proof”), thanks to which you can use this ceiling lamp in every possible place inside and outside. To adapt it to every situation and place, you can choose from: two luminaire shapes, four powers and the option of choosing luminaires with a microwave motion sensor (SE models).

5 years Warranty under the terms of the warranty statement, available on our website  
Enclosure material: plastic  
Lampshade material: plastic

# IPER LED

LED- DECKENLEUCHE ▶ CEILING-MOUNTED LED LIGHT FITTING



IPER LED 10W-NW-O



IPER LED 19W-NW-O



IPER LED 26W-NW-O



IPER LED 35W-NW-O



IPER LED 10W-NW-L



IPER LED 19W-NW-L



IPER LED 26W-NW-L



IPER LED 35W-NW-L

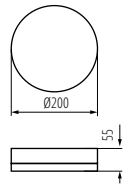

IPER LED 10W-NW-O

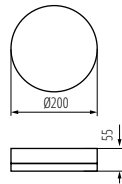

IPER LED 19W-NW-O

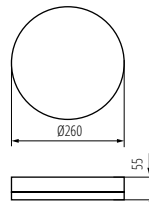

IPER LED 26W-NW-O

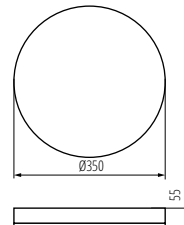

IPER LED 35W-NW-O

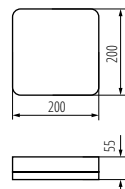

IPER LED 10W-NW-L

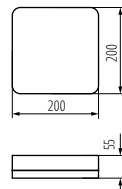

IPER LED 19W-NW-L

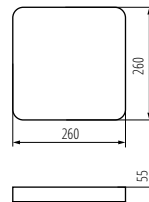

IPER LED 26W-NW-L

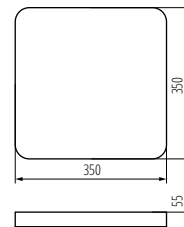

IPER LED 35W-NW-L





# BENO LED

LED- DECKENLEUCHTE ► CEILING-MOUNTED LED LIGHT FITTING



BENO 18W L-GR; BENO 18W L-SE GR



BENO 18W O-W; BENO 18W O-SE W



BENO 18W O-GR; BENO 18W O-SE GR



BENO 18W L-W; BENO 18W L-SE W



BENO 18W L-GR; BENO 18W L-SE GR



BENO 24W O-W; BENO 24W O-SE W



BENO 24W O-GR; BENO 24W O-SE GR



BENO 24W L-W; BENO 24W L-SE W



BENO 24W L-GR; BENO 24W L-SE GR



Kanlux BENO LED ist eine Serie von Wand- und Deckenleuchten mit oder ohne Bewegungssensor. Das Design der Leuchte ist geschützt, was bedeutet, dass die BENO LED nur bei Kanlux erhältlich ist. Die hohe Beständigkeit gegen Witterungseinflüsse ist durch IP54 gewährleistet. Die LED-Leuchte BENO kann sowohl im Innenbereich (Bad, Küche, Wohnraum), als auch im Außenbereich (Fassade) schnell und unkompliziert montiert werden.

Gehäusematerial: Kunststoff  
Abdeckungsmaterial: Kunststoff

Kanlux BENO luminaries that's unique design and unique light effect. They were created on the basis of individual order of Kanlux, and their designs were registered by us at the patent office. Kanlux BENO LED also provides high weather resistance (IP54), quick and easy installation on the ceiling or wall, and Beno is equipped with the adjustable movement sensor (in versions -SE). Kanlux BENO LED is a multifunctional fitting, which due to its design and its technical aspects, we can apply practically anywhere.

Enclosure material: plastic  
Lampshade material: plastic

# BENO LED

LED- DECKENLEUCHE ▶ CEILING-MOUNTED LED LIGHT FITTING



BENO 24W O-W, BENO 24W O-SE W



BENO 18W NW-O-W	<b>32940</b>	5905339329400	18	1550	4000	weiß   white	
BENO 18W NW-L-W	<b>32942</b>	5905339329424	18	1550	4000	weiß   white	
BENO 18W NW-O-SE W	<b>32944</b>	5905339329448	18	1550	4000	weiß   white	Mikrowellen-   microwave
BENO 18W NW-L-SE W	<b>32946</b>	5905339329462	18	1550	4000	weiß   white	Mikrowellen-   microwave
BENO N 18W NW-O-SE GR	<b>32948</b>	5905339329486	18	1400	4000	graphit   graphite	Mikrowellen-   microwave
BENO N 18W NW-L-SE GR	<b>32949</b>	5905339329493	18	1400	4000	graphit   graphite	Mikrowellen-   microwave
BENO N 18W NW-O-GR	<b>33348</b>	5905339333483	18	1400	4000	graphit   graphite	
BENO N 18W NW-L-GR	<b>33349</b>	5905339333490	18	1400	4000	graphit   graphite	
BENO 24W NW-O-W	<b>33340</b>	5905339333407	24	2060	4000	weiß   white	
BENO 24W NW-O-GR	<b>33341</b>	5905339333414	24	1920	4000	graphit   graphite	
BENO 24W NW-L-W	<b>33342</b>	5905339333421	24	2060	4000	weiß   white	
BENO 24W NW-L-GR	<b>33343</b>	5905339333438	24	1920	4000	graphit   graphite	
BENO 24W NW-O-SE W	<b>33344</b>	5905339333445	24	2060	4000	weiß   white	Mikrowellen-   microwave
BENO 24W NW-O-SE GR	<b>33345</b>	5905339333452	24	1920	4000	graphit   graphite	Mikrowellen-   microwave
BENO 24W NW-L-SE W	<b>33346</b>	5905339333469	24	2060	4000	weiß   white	Mikrowellen-   microwave
BENO 24W NW-L-SE GR	<b>33347</b>	5905339333476	24	1920	4000	graphit   graphite	Mikrowellen-   microwave



[V] 220-240 AC	[Hz] 50	[°] 110	[lm] ≥20000	[h] 20000	[lm] ≤ für Nach/däm	Ra 80	Hg	SMD		
IP 54		°C -15+35			[mm] 0,5+1,5	[m] 0,5m	CE	EAC	UK CA	

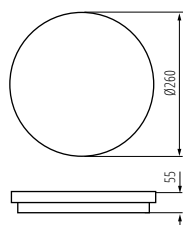

BENO 18W O

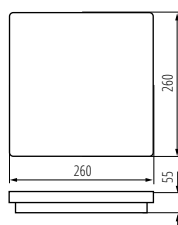

BENO 18W L

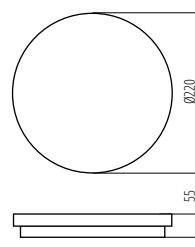

BENO 24W O

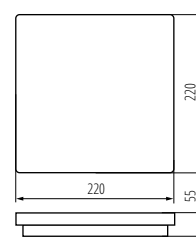

BENO 24W L

# VARSO LED

LED- DECKENLEUCHE ▶ CEILING-MOUNTED LED LIGHT FITTING



VARSO LED 18W-O; VARSO LED 18W-O-SE



VARSO LED 18W-O; VARSO LED 18W-O-SE



VARSO LED 18W-L; VARSO LED 18W-L-SE



VARSO LED 24W-O; VARSO LED 24W-O-SE  
VARSO HI 36W-NW-O; VARSO HI 36W-NW-O-SE



VARSO LED 24W-L; VARSO LED 24W-L-SE  
VARSO HI 36W-NW-L



VARSO LED 18W-WW-O	<b>26440</b>	5905339264404	18	1620	3000	weiß   white	
VARSO LED 18W-NW-O	<b>26441</b>	5905339264411	18	1700	4000	weiß   white	
VARSO LED 18W-NW-L	<b>26443</b>	5905339264435	18	1700	4000	weiß   white	
VARSO LED 24W-WW-O	<b>26444</b>	5905339264442	24	2160	3000	weiß   white	
VARSO LED 24W-NW-O	<b>26445</b>	5905339264459	24	2280	4000	weiß   white	
VARSO LED 24W-NW-L	<b>26447</b>	5905339264473	24	2280	4000	weiß   white	
VARSO HI 36W-NW-O	<b>26448</b>	5905339264480	36	3600	4000	weiß   white	
VARSO HI 36W-NW-L	<b>26449</b>	5905339264497	36	3600	4000	weiß   white	
VARSO LED 18W-NW-L-SE	<b>26980</b>	5905339269805	18	1700	4000	weiß   white	Mikrowellen-   microwave
VARSO LED 18W-NW-O-SE	<b>26981</b>	5905339269812	18	1700	4000	weiß   white	Mikrowellen-   microwave
VARSO LED 24W-NW-L-SE	<b>26983</b>	5905339269836	24	2280	4000	weiß   white	Mikrowellen-   microwave
VARSO LED 24W-NW-O-SE	<b>26984</b>	5905339269843	24	2280	4000	weiß   white	Mikrowellen-   microwave
VARSO HI 36W-NW-O-SE	<b>26985</b>	5905339269850	36	3600	4000	weiß   white	Mikrowellen-   microwave

[VI]	[Hz]	[°]	[h]	[h]	ellipse	Ra	Hg	SMD			IP
220-240 AC	50	120	≥20000	20000	≤ 6x MacAdam	80					54
	[°C]	[mm]	[mm]	[m]	360°	Φuse	CE	EAC	PZH	UK	
	-20+35		0,5-2,5	0,5m							

# VARSO LED

LED-DECKENLEUCHTE ► CEILING-MOUNTED LED LIGHT FITTING



Kanlux VARSO LED ist eine Serie von hermetischen Deckenleuchten mit fest verbauten LED-Leuchtmitteln. Sie sind eine gute Wahl sowohl für gewerbliche Anwendungen (Wohnungsgesellschaften, Hotels etc.) als auch für private Haushalte, in denen eine erhöhte IP-Schutzart erforderlich ist, die diese Leuchte bietet (IP54). Für die Beleuchtung besonders großer Flächen bieten wir Kanlux VARSO HI mit 36 Watt und einem Lichtstrom von bis zu 3600 Lumen an. Bitte beachten Sie, dass auch Modelle mit Bewegungssensor (SE) erhältlich sind.

VARSO LED + SE - Version mit Bewegungssensor

Gehäusematerial: Kunststoff

Abdeckungsmaterial: Kunststoff

Kanlux VARSO LED is a family of hermetic ceiling light fixtures with an integrated LED light source. It is a great choice both for developments (housing co-operatives, hotels) and individual households where increased resistance to humidity (IP54) is needed. For lighting particularly large spaces, we recommend 36W Kanlux VARSO HI with a luminous flux up to 3600 lm. Keep in mind that we also offer Kanlux VARSO fixtures with motion sensors (SE).

VARSO LED + SE - version with a motion sensor

Enclosure material: plastic

Lampshade material: plastic

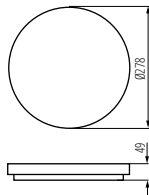

VARSO LED 18W-O

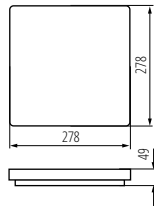

VARSO LED 18W-L

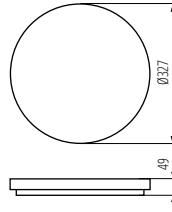

VARSO LED 24W O, VARSO HI 36W O

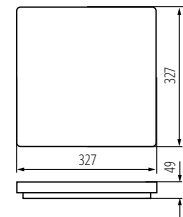

VARSO LED 24W L, VARSO HI 36W L



# STIVI LED

LED- DECKENLEUCHTE ▶ CEILING-MOUNTED LED LIGHT FITTING



STIVI LED 24W-NW-O, STIVI LED 24W-NW-O-SE



STIVI LED 24W-NW-O, STIVI LED 24W-NW-O-SE STIVI LED 36W-NW-O, STIVI LED 36W-NW-O-SE



Kanlux Deckenleuchte STIVI LED bietet Licht, wo Standardleuchten scheitern können. Sie zeichnet sich durch hohe Lichtstärke - 130lm/W, hohe Dichtigkeit - IP65 und Beständigkeit gegen Beschädigungen IK08 aus. Die Kanlux STIVI LED-Leuchte kann im Freien (Balkone, Terrassen, Innenhöfe, offene Lauben), in Fluren und Treppenhäusern sowie an Orten mit erhöhter Luftfeuchtigkeit (Waschräume, Umkleieräume und Durchgänge in Schwimmbädern) eingesetzt werden. Weitere Vorteile sind: 5 Jahre Garantie und 50.000 Stunden Lebensdauer, sowie die Möglichkeit, eine Version mit Bewegungsmelder zu wählen. Wir empfehlen es als hochwertiges Investitionsprodukt oder für den professionellen Einsatz zu Hause.

5 Jahre Garantie gemäß den Bedingungen der Garantieerklärung, die auf der Website verfügbar ist

Gehäusematerial: PC

Abdeckungsmaterial: PC

The Kanlux STIVI LED ceiling light will provide you with lighting where standard luminaires may fail. It is characterised by high luminous efficacy of 130lm/W, a high level of protection - IP65 and impact protection rating of IK08. Kanlux STIVI LED luminaire can be used outdoors (on balconies, terraces, patios, open arbours), in corridors and staircases, as well as in places with increased humidity (laundry rooms, changing rooms and passageways at swimming pools). Additional advantages include: 5-year warranty and 50,000 hours of light source life in the luminaire, as well as the option of choosing a version with a motion sensor. We recommend it as a high-end investment product or for professional domestic use.

5 years Warranty under the terms of the warranty statement, available on our website

Enclosure material: PC

Lampshade material: PC



STIVI LED 24W-NW-O	<b>35000</b>	5905339350008	24	3120	4000	weiß   white	
STIVI LED 24W-NW-O-SE	<b>35001</b>	5905339350015	24	3120	4000	weiß   white	Mikrowellen-   microwave
STIVI LED 36W-NW-O	<b>35002</b>	5905339350022	36	4680	4000	weiß   white	
STIVI LED 36W-NW-O-SE	<b>35003</b>	5905339350039	36	4680	4000	weiß   white	Mikrowellen-   microwave

[V]	[Hz]	[°]	[h]	[h]	ellipse	Ra	Hg	SMD	UK	IP	🏠
220-240 AC	50	110	≥30000	50000	≤ 6x Mac/dam	80				65	
🌡️ -20+40	🔌	<b>IK</b> 08	📦	📏 0,5-2,5	📏 0,5m	🌞 360° 0use	CE	ERL	UK	🌱	

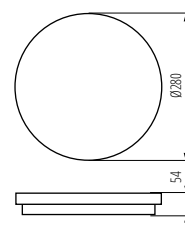

STIVI LED 24W

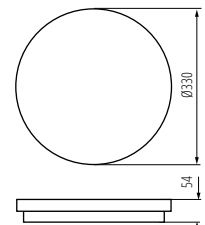

STIVI LED 36W

# ORTE LED

LED- DECKENLEUCHE ▶ CEILING-MOUNTED LED LIGHT FITTING



ORTE LED 18W-NW-O



ORTE LED 18W-O, ORTE LED 18W-O-SE

ORTE LED 24W



Kanlux ORTE LED ist eine neue Serie von Wand- und Deckenleuchten, bei der besonderes Augenmerk auf Design und einfache Installation gelegt wurde. Für zusätzlichen Komfort bieten wir Ihnen auch Versionen mit Bewegungsmelder an.

Gehäusematerial: Kunststoff  
Abdeckungsmaterial: Kunststoff



Kanlux ORTE LED is a new family of wall and ceiling fixtures in which particular attention has been paid to design and ease of installation. For added convenience, you can also choose from various motion detector versions.

Enclosure material: plastic  
Lampshade material: plastic



ORTE LED 18W-NW-O	<b>29160</b>	5905339291608	18	1600	4000	weiß   white	
ORTE LED 24W-NW-O	<b>29161</b>	5905339291615	24	2200	4000	weiß   white	
ORTE LED 18W-NW-O-SE	<b>29162</b>	5905339291622	18	1600	4000	weiß   white	Mikrowellen-   microwave
ORTE LED 24W-NW-O-SE	<b>29163</b>	5905339291639	24	2200	4000	weiß   white	Mikrowellen-   microwave

[V] 220-240 AC	[Hz] 50	[°] 120	[h] ≥20000	[h] 20000	ellipse ≤6x Nachdäm	Ra 80	Hg	SMD		
IP 54		[°C] -20+35			[mm] 0,75+2,5	0,5m	CE	ERC	UK CA	

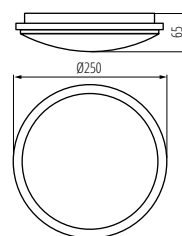

ORTE LED 18W

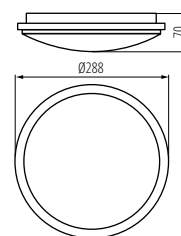

ORTE LED 24W

# Kanlux DABA PRO

LED- DECKENLEUCHTE ► CEILING-MOUNTED LED LIGHT FITTING



DABA PRO 25W NW-W



Kanlux DABA PRO ist eine Leuchte für professionelle Anwendungen. Zur Auswahl stehen eine Version ohne Bewegungssensor (25W) und mit Sensor (26W) sowie zwei Gehäusefarben - weiß und schwarz. Die Kanlux DABA PRO-Leuchten sind nach IP65 wasserdicht und sehr witterungsbeständig, außerdem widerstandsfähig gegen mechanische Beschädigungen (IK10) und zusätzlich gegen das Öffnen der Leuchte geschützt. Kanlux DABA PRO-Leuchten können nach der Regel MASTER → SLAVE kombiniert werden, d.h. die erste (die erste und die letzte) mit dem Sensor ausgestattete Leuchte steuert die Reihenfolge der Leuchten. Die hohe Qualität der Herstellung der Kanlux DABA PRO-Leuchten wird durch die 5-Jahres-Garantie bestätigt.

5 Jahre Garantie gemäß den Bedingungen der Garantieerklärung, die auf der Website verfügbar ist  
Gehäusematerial: Kunststoff  
Abdeckungsmaterial: PC

Kanlux DABA PRO are ceiling lamps for professional use. We can choose a version without a motion sensor (25W) and with a sensor (26W) and two housing colors - white and black. Kanlux DABA PRO means IP65 tightness and high resistance to weather conditions, as well as resistance to mechanical damage IK10 and additional protection of the luminaire against opening. Kanlux DABA PRO plafonds can be combined with each other on the MASTER → SLAVE principle, i.e. the first (first and last) luminaire with a sensor controls the series of luminaires. The high quality of Kanlux DABA PRO ceiling fixtures is confirmed by a 5-year warranty.

5 years Warranty under the terms of the warranty statement, available on our website  
Enclosure material: plastic  
Lampshade material: PC

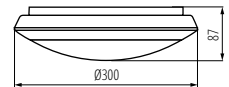

DABA PRO 25W



DABA PRO 26W NW-W	<b>19064</b>	5905339190642	25	2800	4000	weiß   white	
DABA PRO 26W NW-SE-W	<b>19066</b>	5905339190666	26	2800	4000	weiß   white	Mikrowellen-   microwave

[V]	[Hz]	[°]	[h]	[lm]	Ra	Hg	SMD	
220-240 AC	50	115	≥25000	50000	≤ 6x MacKadm	80		
IP 65		-20+40	IK 10	0,75-2,5	0,5m	24	3600	CE
ERC	UK CA							

# Kanlux DABA N LED SMD

LED- DECKENLEUCHTE ► CEILING-MOUNTED LED LIGHT FITTING



DABA N LED SMD DL-16W



Die energieeffiziente Kanlux DABA N-Leuchte bietet die Möglichkeit, die Kosten für den Energieverbrauch dank der eingesetzten Bewegungs- und Dämmerungssensoren zu senken. Dies bewirkt, dass sie nur dann leuchtet, wenn es nötig ist. Darüber hinaus kann sie dank ihrer Parameter (IP66, IK10) praktisch überall installiert werden! Die Funktion STAND BY DIMMING bedeutet, dass der Deckenleuchter nach einer programmierten Zeit ohne Bewegung in den StandbyModus wechselt und den Lichtstrom auf 20% reduziert.

Gehäusematerial: PC  
Abdeckungsmaterial: PC

Kanlux DABA N is an energy-efficient luminaire allows for decreasing energy consumption costs due to the use of motion detectors and dusk-to-dawn sensors. Therefore, it emits light only when it is necessary. Moreover, its parameters (IP66, IK10) allow for mounting it in almost every place! The ceiling luminaire enters standby mode and decreases the luminous flux to 20% after the pre-set time in the absence of motion using the STAND BY DIMMING function.

Enclosure material: PC  
Lampshade material: PC

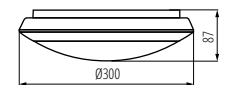

DABA N LED SMD DL-16W



DABA N LED SMD DL-16W	<b>19062</b>	5905339190628	16	1300	4000	weiß   white	Mikrowellen-   microwave
-----------------------	--------------	---------------	----	------	------	--------------	--------------------------

[V]	[Hz]	[°]	[h]	[lm]	Ra	Hg	SMD	
220-240 AC	50	120	≥20000	40000	≤ 6x MacKadm	80		
IP 66		-15+35	IK 10	0,75-2,5	max 8	H360		
10-10	5/15/50/2000	0,5m	CE	ERC	PZH	UK CA		

# TYBIA LED

LED- DECKENLEUCHE ▶ CEILING-MOUNTED LED LIGHT FITTING



TYBIA LED 38W-NW



TYBIA LED 38W GY, SE



TYBIA LED 28W GY, SE



TYBIA LED 38W B, SE



TYBIA LED 28W B, SE



**5**  
WARRANTY  
5 years

**LED**  
techno  
logy

**MO  
DE  
RN**  
design

Kanlux TYBIA LED ist eine Leuchte für Allgemeinbeleuchtung, in der SMD-Dioden verwendet werden. Die Montage von TYBIA LED in Fluren, Treppenhäusern, Sozial- oder Wirtschaftsräumen garantiert erhebliche Einsparungen nicht nur in Bezug auf den Energieverbrauch, sondern auch in Bezug auf einen langen, wartungsfreien Betrieb.

5 Jahre Garantie gemäß den Bedingungen der Garantieerklärung, die auf der Website verfügbar ist  
Gehäusematerial: Aluminiumlegierung

Abdeckungsmaterial: PMMA

Kanlux TYBIA LED is a general lighting luminaire using SMD diodes. When mounted in corridors, staircases, social or utility rooms, TYBIA LED allows for significant savings related to both reduced energy consumption and the long-term maintenance-free operation.

5 years Warranty under the terms of the warranty statement, available on our website

Enclosure material: aluminum alloy

Lampshade material: PMMA



TYBIA LED 38W-NW	<b>24640</b>	5905339246400	38	3800	4000	grau \ weiß   grey \ white	≥20000
TYBIA LED 38W-NW-SE	<b>24641</b>	5905339246417	38	3800	4000	grau \ weiß   grey \ white	Mikrowellen-   microwave ≥20000
TYBIA LED 38W-NW-B	<b>24642</b>	5905339246424	38	3800	4000	schwarz   black	≥20000
TYBIA LED 38W-NW-SE-B	<b>24643</b>	5905339246431	38	3800	4000	schwarz   black	Mikrowellen-   microwave ≥20000
TYBIA M.25W-NW-GY	<b>24644</b>	5905339246448	25	2600	4000	grau   grey	≥15000
TYBIA M.25W-NW-B	<b>24645</b>	5905339246455	25	2600	4000	schwarz   black	≥15000
TYBIA M.25W-NW-SE-GY	<b>24646</b>	5905339246462	25	2600	4000	grau   grey	Mikrowellen-   microwave ≥15000
TYBIA M.25W-NW-SE-B	<b>24647</b>	5905339246479	25	2600	4000	schwarz   black	Mikrowellen-   microwave ≥15000

<b>[V]</b> 220-240 AC	<b>[Hz]</b> 50	<b>[°]</b> 110	<b>[h]</b> 30000	<b>Ra</b> 80 ellipse ≤ 6x MacAdam	<b>Hg</b>	<b>SMD</b>	<b>IP</b> 20
	<b>[°C]</b> 5+25			<b>1-2,5</b>	<b>0,5m</b>	<b>CE</b> <b>ERC</b> <b>UK CA</b>	

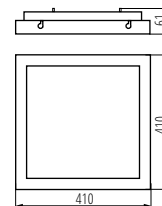

TYBIA LED 38W

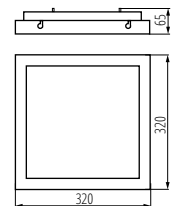

TYBIA LED 25W



# JURBA DL

DECKENLEUCHTE FÜR AUSTAUSCHBARE LEUCHTMITTEL  
 ► CEILING-MOUNTED LIGHT FITTING WITH REPLACEABLE LIGHT SOURCE



JURBA DL-2180



Der hermetische Kanlux JURBA-Deckenleuchte, vorgesehen für austauschbare E27 Leuchtmittel, zeichnet sich durch eine hervorragende Ausführungsqualität aus. Die Leuchte kann sowohl an der Wand als auch an der Decke innerhalb und außerhalb von Gebäuden installiert werden. Kanlux JURBA-Leuchten haben eine erhöhte Staub- und Wasserdichtigkeit - IP44.

Gehäusematerial: Stahl  
 Abdeckungsmaterial: PC

Kanlux JURBA is a hermetic ceiling light fixture of excellent workmanship. The fixture can be mounted both on ceilings and on walls, indoors and outdoors. The increased protection rating IP44 of Kanlux JURBA luminaires protects them from dust, particles and moisture.

Enclosure material: steel  
 Lampshade material: PC



JURBA DL-2180



JURBA DL-218L



JURBA DL-2180	<b>08980</b>	5905339089809	2 x max 18	CFL\LED	E27	Nickel satiniert   nickel satin
JURBA DL-218L	<b>08981</b>	5905339089816	2 x max 18	CFL\LED	E27	Nickel satiniert   nickel satin

[V] 220-240 AC	[Hz] 50	IP 44	°C -10+35	UK CA
mm 1-2,5	m 0,1m	CE	ERL	UK CA

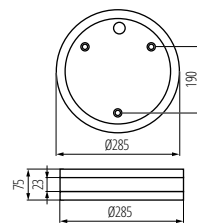

JURBA DL-2180

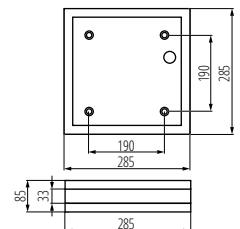

JURBA DL-218L

# PIRES DL

DECKENLEUCHTE FÜR AUSTAUSCHBARE LEUCHTMITTEL  
 ► CEILING-MOUNTED LIGHT FITTING WITH REPLACEABLE LIGHT SOURCE



PIRES DL-600



PIRES DL-600 NS



PIRES ECO DL-250



PIRES ECO DL-250 NS



Kanlux PIRES ist eine minimalistische Deckenleuchte, die dank einer erhöhten Staub- und Wasserdichtigkeit - IP44 auch im Außenbereich eingesetzt werden kann. Für mehr Komfort bieten wir auch Versionen an, die mit einem Mikrowellen-Bewegungsmelder (Art. Nr. 19000 und 8810) mit einer Bewegungserfassungsreichweite von 9 Metern ausgestattet sind). Der Vorteil der Leuchte ist auch die Möglichkeit, die Beleuchtungsdauer im Bereich von 8 Sekunden bis 12 Minuten einzustellen.

Ausgestattet mit einem Mikrowellen-Bewegungssensor (8810, 19000)  
 Maximaler horizontaler Erkennungswinkel des Bewegungssensors beträgt 360°  
 Maximaler vertikaler Erkennungswinkel des Bewegungssensors beträgt 140°  
 Regulierbare Lichtzeit von 8 Sekunden bis 12 Minuten  
 Maximale Reichweite der Bewegungserkennung beträgt 9m  
 Bewegungserkennung 0.3...3m/s (1...10km/h), Einstellung der Empfindlichkeit im Bereich von 2 bis 2000 lx  
 Gehäusematerial: Kunststoff

Kanlux PIRES is a ceiling light fixture with minimalistic appearance which can be used outside too thanks to IP44 degree of tightness. To increase comfort, we also propose versions equipped with a microwave motion detector (code 19000 and 8810) the range of which comes to 9 metres.

PIRES DL-60 NS, PIRES ECO DL-250 NS version - without motion sensor  
 provided with a MW motion sensor (8810, 19000)  
 maximum horizontal adjustment range for the motion sensor: 360°  
 maximum vertical motion sensor angle: 140°  
 lighting time adjustable in the range of 8 s to 12 min  
 maximum motion detection range: 9 m  
 motion detection 0.3...3 m/s (1...10 km/h), sensitivity adjustment range: 2...2,000 lx  
 Enclosure material: plastic



Abdeckungsmaterial

PIRES ECO DL-250	19000	5905339190000	max 25	CFL/LED	E27	Kunststoff   plastic	weiß   white	Mikrowellen-   microwave
PIRES ECO DL-250 NS	19001	5905339190017	max 25	CFL/LED	E27	Kunststoff   plastic	weiß   white	

<b>[V]</b> 220-240 AC	<b>[Hz]</b> 50	<b>IP</b> 44	<b>5+35</b>	<b>UKCA</b>
<b>1-2,5</b>	<b>0,5m</b>	<b>CE</b>	<b>EAC</b>	<b>UKCA</b>

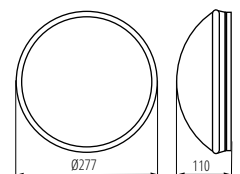

PIRES ECO DL-250; PIRES ECO DL-250 NS

Kanlux

# FOGLER LED

LED- DECKENLEUCHTE ► CEILING-MOUNTED LED LIGHT FITTING



FOGLER LED 14W-NW



FOGLER LED 14W-NW | 18121 | 5905339181213 | 14 | 800 | 4000 | weiß | white | PIR

[V] 220-240 AC	[Hz] 50	[°] 110	[lx] ≥15000	[h] 20000	[lx] ≤ 6lx Max/dam	[Ra] 80	[SMD]	[E]	[IP] 20	[°C] 5+25
[mm] 0,5-2,5	[m] max 6	[s] - [min] 360	[lx] 10-5	[lx] 5-2000	[m] 0,5m	[lm] 57	[CE]	[EAC]	[UK]	[CA]



Deckenleuchte Kanlux FOGLER LED mit Bewegungssensor eignet sich ideal für die Beleuchtung von Treppenhäusern, technischen Räumen in Mehrfamilienhäusern, Kellern sowie Garagen und Einfahrten in Einfamilienhäusern.

Gehäusematerial: Stahl  
Abdeckungsmaterial: PC

Kanlux FOGLER LED ceiling light fixture with motion detector is a great solution for lighting staircases, technical rooms in multi-family buildings, storage rooms, basements, garages and driveways in detached houses.

Enclosure material: steel  
Lampshade material: PC

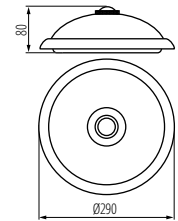

FOGLER LED 14W-NW

Kanlux

# FOGLER DL

DECKENLEUCHTE FÜR AUSTAUSCHBARE LEUCHTMITTEL ► CEILING-MOUNTED LIGHT FITTING WITH REPLACEABLE LIGHT SOURCE



FOGLER DL-2400



FOGLER DL-2400 | 18120 | 5905339181206 | 2 x max 40 | GLS\CFL\LED | E27 | weiß | white

[V] 220-240 AC	[Hz] 50	[IP] 20	[°C] 5+25	[lx] ≥ 15000	[m] max 8
[lx] H360/V120	[s] - [min] 12-5	[PIR]	[lx] 3-2000	[m] 0,5m	[CE]



Die Kanlux FOGLER DL Deckenleuchte, vorgesehen für austauschbare E27 Leuchtmittel, ist für Treppenhäuser, Flure, Dachböden und andere derartige Räume ideal geeignet. Der eingebaute Sensor mit einem maximalen Bewegungserkennungswinkel (360°) gewährleistet es, dass sich die Leuchte genau dann einschaltet, wenn man Licht benötigt.

Ausgestattet mit einem Bewegungssensor  
Maximaler horizontaler Erkennungswinkel des Bewegungssensors beträgt 360°  
Maximaler vertikaler Erkennungswinkel des Bewegungssensors beträgt 120°  
Regulierbare Lichtzeit von 5 Sekunden bis 5 Minuten  
Maximale Reichweite der Bewegungserkennung beträgt 8m  
Bewegungserkennung 0.3...3m/s (1...10km/h)  
Gehäusematerial: Stahl  
Abdeckungsmaterial: Glas

Kanlux FOGLER DL ceiling light fixture with a replaceable light source is a great choice for staircases, basements, attics and similar spaces. The built-in detector with the maximum angle (360°) of motion detection guarantees that the light turns on exactly when we need it.

provided with a motion sensor  
maximum horizontal adjustment range for the motion sensor: 360°  
maximum vertical motion sensor angle: 120°  
lighting time adjustable in the range of 5 s to 5 min  
maximum motion detection range: 8 m  
motion detection 0.3...3 m/s (1...10 km/h)

Enclosure material: steel  
Lampshade material: glass

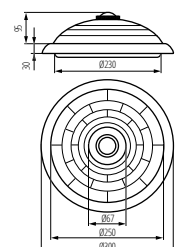

FOGLER DL-2400

# Kanlux SANSO LED

LED-DECKENLEUCHE ► CEILING-MOUNTED LED LIGHT FITTING



SANSO LED 15W-NW-SE



Die Deckenleuchte Kanlux SANSO-LED verfügt über einen integrierten PIR-Bewegungssensor, wodurch die Leuchte an die eigenen Bedürfnisse angepasst werden kann. Die Leuchte zeichnet sich auch durch erhöhte Dichtheit (IP 44) aus, wodurch das Innere der Leuchte vor Staub geschützt wird.

5 Jahre Garantie gemäß den Bedingungen der Garantieerklärung, die auf der Website verfügbar ist

Gehäusematerial: PC

Abdeckungsmaterial: PC

Kanlux SANSO LED ceiling luminaire with a built-in motion detector PIR allows for its customisation depending on your needs. It is also characterised by increased tightness (IP 44) so its inside is protected against dust and dirt.

5 years Warranty under the terms of the warranty statement, available on our website

Enclosure material: PC

Lampshade material: PC



SANSO LED 15W-NW-SE | 26520 | 5905339265203 | 15 | 1250 | 4000 | weiß | white | PIR

[V]	[Hz]	[°]	[h]	[h]	[h]	[Ra]	[Hg]	[SMD]	[IP]
220-240 AC	50	120	≥10000	15000	≤ für Nachtdäm	80			44
[°C]	[mm²]	[m]	[m]	[lx]	[s]	[lx]	[lx]	[Im]	[Pon]
-20+35	0,5-1,5	max 6	H160	5-5	8-2000	0,5m	83	13	
[lm] Glare	[°]	[W]	CE	ERC	UK CA				
2000	360°	125							

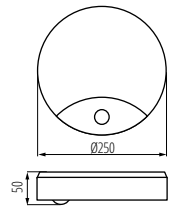

SANSO LED 15W-NW-SE

# Kanlux MARC DL

DECKENLEUCHE FÜR AUSTAUSCHBARE LEUCHTMITTEL ► CEILING-MOUNTED LIGHT FITTING WITH REPLACEABLE LIGHT SOURCE



MARC DL-60



Kanlux MARC DL-Deckenleuchte ist ein einfaches Design, hohe Beständigkeit gegen Staub, Feuchtigkeit (IP54) und UV-Strahlung sind zusätzliche Vorteile dieser Leuchte.

Hohe UV-Beständigkeit (PIKTO)

Gehäusematerial: PC

Abdeckungsmaterial: PC

Kanlux MARC DL ceiling light fixture combines high resistance to dust, moisture (IP54) and UV radiation are other assets of the luminaire.

high UV resistance (PIKTO)

Enclosure material: PC

Lampshade material: PC



MARC DL-60 | 07015 | 5905339070159 | max 60 | GLS\CFL\LED | E27 | weiß | white

[V]	[Hz]	[IP]	[°C]	[mm²]	[m]
220-240 AC	50	54	-10+35	1-1,5	0,5m
[lm]	[m]	CE	ERC	UK CA	

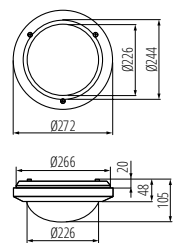

MARC DL-60

# Kanlux ERTON

DECKENLEUCHE FÜR AUSTAUSCHBARE LEUCHTMITTEL ▶ CEILING-MOUNTED LIGHT FITTING WITH REPLACEABLE LIGHT SOURCE



ERTON 140 OP-W



ERTON 140 OP-W	<b>35770</b>	5905339357700	max 15	GLS\CFL\LED	E27	weiß   white
ERTON 240 OP-W	<b>35771</b>	5905339357717	2x max 15	GLS\CFL\LED	E27	weiß   white

[V] 220-240 AC	[Hz] 50	□	IP 44	🏠	🌡️ -25+35	🔧
📏 0,5m	💡	🔌	CE	ERL	UK	♻️



Kanlux ERTON ist eine ästhetisch ansprechende Lösung für Orte mit erhöhter Feuchtigkeit. Die beiden Leuchtenmodelle bieten die Möglichkeit, leistungsstarke Leuchtmittel zu verwenden - bis zu 15 W, wobei das Modell 240 OP-W zwei Leuchtmittel aufnehmen kann. Diese Leuchten sind dank der Schutzart IP44 sowohl für professionelle Lösungen im privaten als auch im gewerblichen Bereich geeignet.

Gehäusematerial: Kunststoff

Abdeckungsmaterial: PC

The Kanlux ERTON ceiling lamp is an aesthetic solution for places with increased humidity. Two models of luminaires can use strong light sources - up to 15 W, of which the 240 OP-W model contains two light sources. These luminaires, thanks to the IP44 rate, are suitable for professional home and commercial solutions.

Enclosure material: plastic

Lampshade material: PC

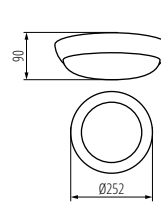

ERTON 140 OP-W

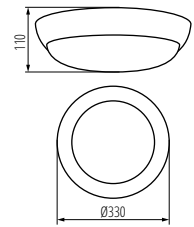

ERTON 240 OP-W

# Kanlux PLAFMIN

DECKENLEUCHE ▶ CEILING LIGHT FITTING



PLAFMIN O



PLAFMIN O	<b>25690</b>	5905339256904	max 40	E27	GLS\CFL\LED	weiß   white
-----------	--------------	---------------	--------	-----	-------------	--------------

[V] 220-240 AC	[Hz] 50	□	IP 20	🏠	🌡️ 5+25	📦
📏 1+2,5	📏 0,5m	CE	ERL	UK	♻️	



Kanlux PLAFMIN ist der universellste Deckenleuchter in unserem Angebot. Weiße Farbe, neutrale Halbkugelform, fehlende Verzierungen und freie Wahl des Leuchtmittels. Er kann in jedem Innenraum eingesetzt werden (IP20). Wir empfehlen ihn besonders für Hotels, Restaurants und Wohnräume im skandinavischen oder minimalistischen Stil.

Gehäusematerial: Kunststoff

Abdeckungsmaterial: Kunststoff

Kanlux PLAFMIN is the most universal ceiling light fixture in our offer. White colour, neutral shape of hemisphere, lack of any ornaments and independent selection of light source. It can be used in each interior (IP20), it is particularly recommended to hotels, restaurants and home interiors in the Scandinavian or minimalist style.

Enclosure material: plastic

Lampshade material: plastic

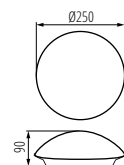

PLAFMIN O

# Kanlux HERMI

KELLERLEUCHE ▶ BULKHEAD FIXTURE



HERMI 7063NB



HERMI 7063NB | **70524** | 5905339705242 | max 100 | GLS\CFL\LED | E27 | weiß | white

[V] 220-240 AC	[Hz] 50	[mm] 1-1,5	IP 54	[-20+25]	UK CA
[mm] 1-1,5	[mm] 1-1,5	[mm] 1-1,5	CE	EAC	UK CA

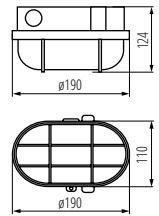

HERMI 7063NB

# Kanlux MILO

KELLERLEUCHE ▶ BULKHEAD FIXTURE



MILO 7040T/P-B



MILO 7040T/P-B | **08092** | 5905339080929 | max 60 | GLS\CFL\LED | E27 | schwarz | black  
 MILO 7040T | **70522** | 5905339705228 | max 60 | GLS\CFL\LED | E27 | grau | grey  
 MILO 7040T/P | **70523** | 5905339705235 | max 60 | GLS\CFL\LED | E27 | grau | grey

[V] 220-240 AC	[Hz] 50	[mm] 1-1,5	IP 54	IK 06	UK CA
[mm] 1-1,5	[mm] 1-1,5	[mm] 0,5m	CE	EAC	UK CA



MILO 7040T



MILO 7040T/P



Kanlux MILO ist eine klassische Leuchte, die üblicherweise in Technikräumen, Garagen, Kellern, Treppenhäusern, Fluren usw. eingesetzt wird. Diese Leuchte verfügt über ein Metallschutzgitter, das den Schirm der Leuchte zusätzlich vor mechanischen Beschädigungen schützt.

Gehäusematerial: Kunststoff  
Abdeckungsmaterial: Glas

Kanlux MILO is a classic channel luminaire used usually in technical rooms, garages, basements, staircases, corridors, etc. The luminaire has a metal (7040T) or plastic (7040T/P) protective mesh which protects the shade from mechanical damage.

Enclosure material: plastic  
Lampshade material: glass

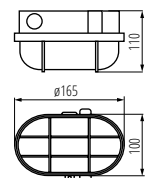

MILO 7040

# Kanlux INES

KELLERLEUCHE ▶ BULKHEAD FIXTURE



INES 7061N



INES 7061N | 70525 | 5905339705259 | max 100 | GLS\CFL\LED | E27 | weiß | white

[V] 220-240 AC	[Hz] 50	[IP] 43	[W] max 100	[E27]	[Color] weiß   white
[Lumen] 1	[Beam angle] 0,5m	[Certification] CE, ENEC, UKCA	[Material] Kunststoff	[Protection] IP43	[Light source] GLS\CFL\LED

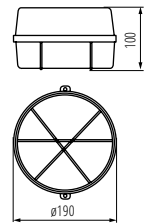

INES 7061N



Kanlux INES ist eine robuste hermetische Leuchte (IP43 / IK08), die für ein auswechselbares Leuchtmittel E27 vorgesehen ist. Sie bietet einen zusätzlichen Schutz in Form eines Metallgitters.

Gehäusematerial: Kunststoff  
Abdeckungsmaterial: Glas

Kanlux INES is a durable hermetic luminaire (IP43 / IK08) with a replaceable light source and additional protection - a metal mesh.

Enclosure material: plastic  
Lampshade material: glass

# Kanlux SANGA DL

DECKENLEUCHE FÜR AUSTAUSCHBARE LEUCHTMITTEL ▶ CEILING-MOUNTED LIGHT FITTING WITH REPLACEABLE LIGHT SOURCE



SANGA DL-100



SANGA DL-100 | 08050 | 5905339080509 | max 100 | GLS\CFL\LED | E27 | weiß | white

[V] 220-240 AC	[Hz] 50	[IP] 44	[W] max 100	[E27]	[Color] weiß   white
[Lumen] 1-1,5	[Beam angle] 0,5m	[Certification] CE, ENEC, UKCA	[Material] Kunststoff	[Protection] IP44	[Light source] GLS\CFL\LED

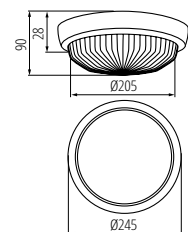

SANGA DL-100



Die Deckenleuchte Kanlux SANGA ist eine wirtschaftliche Lösung für Treppenhäuser, Keller, Dachböden, Garagen, aber auch für Terrassen und Balkone.

Gehäusematerial: Kunststoff  
Abdeckungsmaterial: Glas

Kanlux SANGA ceiling fixture is an economical solution for staircases, basements, attics, garages, and also for terraces and balconies.

Enclosure material: plastic  
Lampshade material: glass

# Kanlux TUNA

DECKENLEUCHE FÜR AUSTAUSCHBARE LEUCHTMITTEL ▶ CEILING-MOUNTED LIGHT FITTING WITH REPLACEABLE LIGHT SOURCE



TUNA S1101-W



TUNA S1101-W	<b>04260</b>	5905339042606	max 100	GLS\CFL\LED	E27	weiß   white
TUNA MINI N	<b>08091</b>	5905339080912	max 100	GLS\CFL\LED	E27	weiß   white

[V] 220-240 AC	[Hz] 50	□	<b>IP</b> 44	🏠	🔧	🔩
☀️ 1-1,5	📏 0,5m	🕸️	CE	ERC	UK CA	♻️



TUNA MINI N



Die Deckenleuchte Kanlux TUNA ist eine Lösung für Treppenhäuser, Keller, Dachböden und andere derartige Räume. Aufgrund der entsprechenden Schutzart gegen Staub und Feuchtigkeit kann die Leuchte sowohl innerhalb als auch außerhalb von Gebäuden eingesetzt werden.

Gehäusematerial: Kunststoff  
Abdeckungsmaterial: Glas

Kanlux TUNA ceiling light fixture is a good choice for staircases, basements, attics and other such rooms. Proper level of protection against dust and moisture allows for its use both indoors and outdoors.

Enclosure material: plastic  
Lampshade material: glass

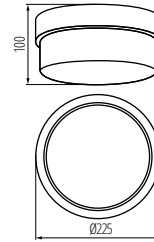

TUNA S1101

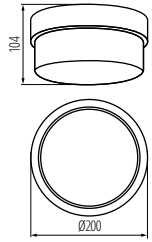

TUNA MINI

# Kanlux TURK

DECKENLEUCHE FÜR AUSTAUSCHBARE LEUCHTMITTEL ▶ CEILING-MOUNTED LIGHT FITTING WITH REPLACEABLE LIGHT SOURCE



TURK DL-60



TURK DL-60	<b>07025</b>	5905339070258	max 60	E27	weiß   white
------------	--------------	---------------	--------	-----	--------------

[V] 220-240 AC	[Hz] 50	□	<b>IP</b> 54	🏠	🔧	🔩
☀️ 1-2,5	📏 0,5m	🕸️	CE	ERC	UK CA	♻️



Kanlux TURK ist sehr widerstandsfähig gegen UV-Strahlung und eignet sich daher perfekt für die Verwendung im Freien, z. B. an einer Gebäudefassade, auf einer Terrasse oder einem Balkon.

Hohe UV-Beständigkeit (PIKTO)  
Gehäusematerial: PC  
Abdeckungsmaterial: PC

Kanlux TURK is a fixture with high resistance to UV radiation makes it perfect for outdoor use, e.g. on building façade, terrace or balcony.

high UV resistance (PICTO)  
Enclosure material: PC  
Lampshade material: PC

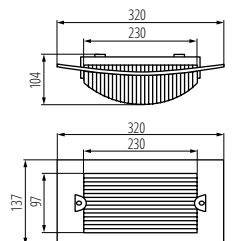

TURK DL-60



# HIMA LED

DOWNLIGHT ► DOWNLIGHT FITTING



HIMA LED 23W-NW-W



HIMA LED 23W-NW-W



HIMA LED 23W-NW-B



HIMA LED 33W-NW-W



Kanlux HIMA LED-Downlights sind Leuchten mit hoher Lichtausbeute (über 110 lm/W). Die Möglichkeit, die Leuchten in zwei Achsen zu verstellen, und der hohe Farbwiedergabeindex machen die Leuchten ideal für Orte, an denen es wichtig ist, bestimmte Zonen und Farben zu beleuchten - Boutiquen, Verkaufsstände oder großflächige Geschäfte. Kanlux HIMA LED ist eine leistungsstarke Leuchte, die auch in hohen Räumen die richtige Lichtmenge liefert. Die Zuverlässigkeit dieser Lampen wird durch die 5-jährige Garantie bestätigt.



5 Jahre Garantie gemäß den Bedingungen der Garantieerklärung, die auf der Website verfügbar ist

Gehäusematerial: Aluminiumlegierung

Abdeckungsmaterial: Glas

Kanlux HIMA LED downlights are luminaires with high luminous efficiency (over 110 lm/W). The possibility of adjusting the luminaires in two axes and high colour rendering index make the luminaires ideal for places where it is important to expose specific zones and colours - boutiques, sales stands or large-format stores. Kanlux HIMA LED is a high power luminaire, so it will provide the right amount of light even in high rooms. The reliability of these lamps is confirmed by a 5-year warranty.

5 years Warranty under the terms of the warranty statement, available on our website

Enclosure material: aluminum alloy

Lampshade material: glass



HIMA LED 23W-NW-W	<b>22841</b>	5905339228413	23	weiß   white	2510	45	4000
HIMA LED 23W-NW-B	<b>22842</b>	5905339228420	23	schwarz   black	2510	45	4000
HIMA LED 33W-NW-W	<b>22843</b>	5905339228437	33	weiß   white	3670	45	4000

[V]	[Hz]	[lm]	[h]	[Ra]	[°]	[°C]	[mm]
220-240 AC	50	≥15000	30000	90	45	5+25	175
IP 20							

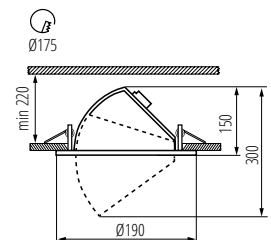

HIMA LED



# TIBERI PRO

EINBAU-DOWNLIGHT ▶ DOWNLIGHT FITTING



TIBERI PRO 20W-940-W



TIBERI PRO 20W-940-B



TIBERI PRO 30W-940-W



TIBERI PRO 30W-940-B



TIBERI PRO 40W-940-W



TIBERI PRO 40W-940-B

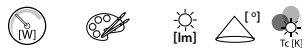

TIBERI PRO 20W-940-W	<b>35670</b>	5905339356703	20	weiß   white	2100	90	4000
TIBERI PRO 20W-940-B	<b>35671</b>	5905339356710	20	schwarz   black	1900	90	4000
TIBERI PRO 30W-940-W	<b>35672</b>	5905339356727	30	weiß   white	3150	90	4000
TIBERI PRO 30W-940-B	<b>35673</b>	5905339356734	30	schwarz   black	2850	90	4000
TIBERI PRO 40W-940-W	<b>35674</b>	5905339356741	40	weiß   white	4200	90	4000
TIBERI PRO 40W-940-B	<b>35675</b>	5905339356758	40	schwarz   black	3800	90	4000

<b>[V]</b> 220-240 AC	<b>[Hz]</b> 50	<b>[h]</b> ≥30000	<b>[h]</b> 50000	<b>[lm]</b> allpse ≤ 6k MacAdam	<b>Ra</b> 90	<b>SMD</b>	<b>IP</b> 44/20
	<b>5+25</b>			<b>0,5m</b>	<b>CE</b>	<b>ERC</b>	<b>UK CA</b>

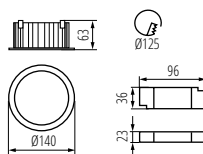

TIBERI PRO 20W

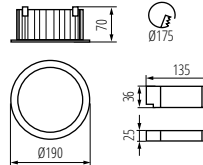

TIBERI PRO 30W

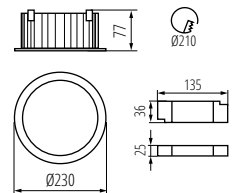

TIBERI PRO 40W

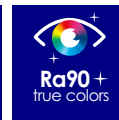

Kanlux TIBERI PRO-Leuchten sind Unterputzleuchten, d.h. sie sind perfekt mit abgehängten Decken kompatibel. Sie beleuchten perfekt Durchgänge, Sanitärräume sowie Büro- und Geschäftsräume. Die Vorteile dieser Downlights sind: 50.000 Stunden Lebensdauer, hohe Wiedergabe natürlicher Farben (CRI>90), Lichtausbeute von bis zu 105lm/W und 5 Jahre Garantie. Die erhöhte Dichtheit (IP44/20) der Kanlux TIBERI PRO-Leuchten schützt sie vor Staub, Schmutz und Feuchtigkeit.

5 Jahre Garantie gemäß den Bedingungen der Garantieerklärung, die auf der Website verfügbar ist

Gehäusematerial: Aluminiumlegierung

Abdeckungsmaterial: Kunststoff

Kanlux TIBERI PRO are flush-mounted luminaires, which means they are perfectly compatible with suspended ceilings. They perfectly illuminate passageways, sanitary facilities or office and retail areas. The advantages of these downlights include: 50,000 hours of service life, excellent reproduction of natural colours (CRI>90), luminous efficacy of up to 105lm/W and a 5-year warranty. The increased protection rating (IP44/20) of Kanlux TIBERI PRO luminaires protects them from dust, particles and moisture.

5 years Warranty under the terms of the warranty statement, available on our website

Enclosure material: aluminum alloy

Lampshade material: plastic

# TIBERI PRO NT

DECKENLEUCHE ▶ DOWNLIGHT FITTING



TIBERI PRO NT20W-940B



TIBERI PRO NT30W-940B



TIBERI PRO NT20W-940W



TIBERI PRO NT30W-940W



Kanlux TIBERI PRO NT ist eine Familie von Anbau-Downlight-Leuchten. Sie sind in zwei Wattstärken (20W und 30W) und zwei Farben (weiß-schwarz) erhältlich, wobei die Größe gleich bleibt. Die Leuchte Kanlux TIBERI PRO zeichnet sich vor allem durch ihre hohe Dichtigkeit (IP54) und ihren hohen Farbwiedergabeindex (Ra>90) aus, aber auch durch ihre einfache Montage an der Decke mit einer Halterung. Die Leuchte Kanlux TIBERI PRO NT steht für qualitativ hochwertige Komponenten, die durch eine 5-Jahres-Garantie bestätigt werden.

5 Jahre Garantie gemäß den Bedingungen der Garantieerklärung, die auf der Website verfügbar ist

Gehäusematerial: Aluminiumlegierung

Abdeckungsmaterial: Kunststoff

Kanlux TIBERI PRO NT is a family of surface-mounted downlights. They are available in two wattages (20W and 30W) and two colors (white and black) while keeping the same size. The Kanlux TIBERI PRO luminaire is primarily characterized by high tightness (IP54) and high color rendering index (Ra > 90), but also easy installation on the ceiling using a bracket. The Kanlux TIBERI PRO NT luminaire is a high quality component confirmed by a 5-year warranty.

5 years Warranty under the terms of the warranty statement, available on our website

Enclosure material: aluminum alloy

Lampshade material: plastic

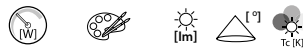

TIBERI PRO NT20W-940W	<b>35676</b>	5905339356765	20	weiß   white	2200	115	4000
TIBERI PRO NT20W-940B	<b>35677</b>	5905339356772	20	schwarz   black	2200	115	4000
TIBERI PRO NT30W-940W	<b>35678</b>	5905339356789	30	weiß   white	3000	115	4000
TIBERI PRO NT30W-940B	<b>35679</b>	5905339356796	30	schwarz   black	3000	115	4000

[V]	[Hz]		[h]					
220-240 AC	50	≥30000	50000	ellipse ≤ 6x MacAdam	Ra 90	SMD		IP 54
			[m]	[mm]	[m]			
			0,18	0,75	0,5m			

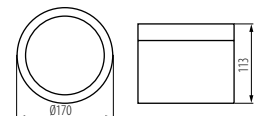

TIBERI PRO NT

# AREL LED

EINBAU-DOWNLIGHT ▶ DOWNLIGHT FITTING



AREL LED D 14W

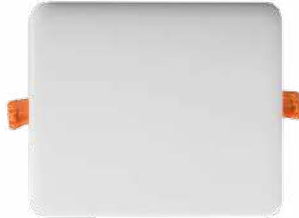

AREL LED DL 14W



AREL LED DO 6W



AREL LED DL 6W



AREL LED DO 10W

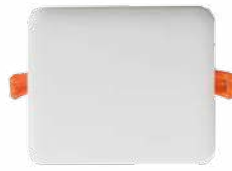

AREL LED DL 10W

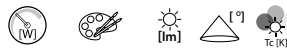

AREL LED DO 6W-NW	<b>29580</b>	5905339295804	6	weiß   white	450	120	4000
AREL LED DO 6W-WW	<b>29581</b>	5905339295811	6	weiß   white	440	120	3000
AREL LED DL 6W-NW	<b>29582</b>	5905339295828	6	weiß   white	490	120	4000
AREL LED DO 10W-NW	<b>29584</b>	5905339295842	10	weiß   white	940	120	4000
AREL LED DO 10W-WW	<b>29585</b>	5905339295859	10	weiß   white	890	120	3000
AREL LED DL 10W-NW	<b>29586</b>	5905339295866	10	weiß   white	1000	120	4000
AREL LED DO 14W-NW	<b>29588</b>	5905339295880	14	weiß   white	1300	120	4000
AREL LED DO 14W-WW	<b>29589</b>	5905339295897	14	weiß   white	1210	120	3000
AREL LED DL 14W-NW	<b>29590</b>	5905339295903	14	weiß   white	1300	120	4000

[V] 220-240 AC	[Hz] 50	[h] ≥30000	[h] 15000	[lm] ≤6xNockdam	[Ra] 80	[SMD]	[Beam]	[IP] 65/20	[House]
[°C] 5+25	[Beam]	[Beam]	[Beam]	[Beam]	[Beam]	[Beam]	[Beam]	[Beam]	[Beam]
			0,75-1,5	0,5m	360° ΦUse	CE	ERC	UK CA	[Recycle]



IP  
65/20

ultra  
SLIM  
panel

HIGH  
quality



Kanlux AREL LED ist eine neue Serie von rahmenlosen Downlights. Die hohe Schutzart IP65/20 und ein einzigartiges, einfaches und gleichzeitig überraschendes Design machen Kanlux AREL LED zu einem idealen Einrichtungselement eines jeden Innenraums. Durch sein einzigartiges Design ist das Panel nur 9 mm dick - es ist das dünnste auf dem Markt erhältliche Panel.

Gehäusematerial: Aluminiumlegierung  
Abdeckungsmaterial: PMMA

Kanlux AREL LED is a new family of downlights which do not have frame. High tightness class IP65/20 and exceptional, simple, and at the same time surprising design make Kanlux AREL LED fit into each interior. Thanks to the unique structure, the panel is only 9 mm thick - it is the thinnest panel available on the market.

Enclosure material: aluminum alloy  
Lampshade material: PMMA



AREL FRAME DO 14W WW **33651** | 5905339336514 weiß | white

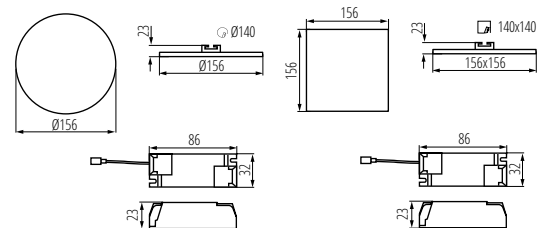

AREL LED DO 14W

AREL LED DL 14W

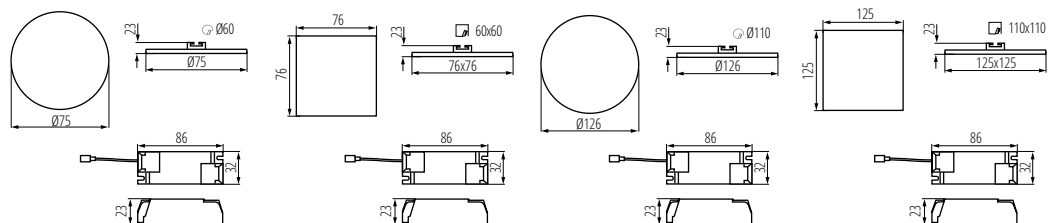

AREL LED DO 6W

AREL LED DL 6W

AREL LED DO 10W

AREL LED DL 10W

Kanlux

# MATEO ES

EINBAU-DOWNLIGHT ► DOWNLIGHT FITTING



MATEO ES DLP-150-B



MATEO ES DLP-150-W



MATEO ES DLP-250-B



MATEO ES DLP-250-W

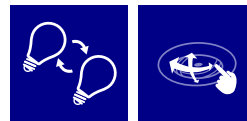

Kanlux MATEO ES ist eine elegante Deckenleuchte, zu der die Leuchtmittel Kanlux ES-111 passen. Der Leuchtenkörper ist aus Stahl gefertigt und mattschwarz lackiert. Wir können zwischen schwarzer oder weißer Farbe der Lampenoberfläche wählen. Dank der Winkelverstellung kann das Licht zielgenau auf den gewählten Punkt gerichtet werden.

Gehäusematerial: Aluminiumlegierung

Kanlux MATEO ES is an elegant ceiling luminaire which can be matched with the spectacular Kanlux ES-111 bulbs. The luminaire body is made of steel and finished in matt black. You can choose between black or white lamp finish. Thanks to angle adjustment, you can direct the light to a selected point.

Enclosure material: aluminum alloy



MATEO ES DLP-150-B	<b>32930</b>	5905339329301	max 25	schwarz   black
MATEO ES DLP-150-W	<b>32931</b>	5905339329318	max 25	weiß   white
MATEO ES DLP-250-B	<b>32932</b>	5905339329325	2 x max 25	schwarz   black
MATEO ES DLP-250-W	<b>32933</b>	5905339329332	2 x max 25	weiß   white

[V] 220-240 AC	[Hz] 50	ES-111	GU10	□	IP 20	🏠	🌡️ 5+25	✈️	🔍
65/35	1,5	0,5m	🔌	CE	ERC	UK CA	🔄		

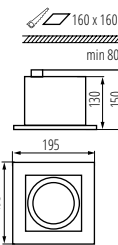

MATEO ES DLP-150

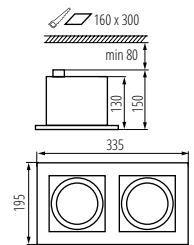

MATEO ES DLP-250

Kanlux

# IVIAN LED

EINBAU-DOWNLIGHT IP44 ► LED SPOTLIGHT FITTING, IP44



IVIAN LED 4,5W W



IVIAN LED 4,5W SN



Kanlux IVIAN LED ist eine Downlight-Serie. Sie zeichnet sich durch eine erhöhte Schutzart aus - IP44, die den Einsatz in Badezimmern und Räumen mit erhöhter Luftfeuchtigkeit möglich macht. Die Leuchte hat fest verbaute SMD-LED-Leuchtmittel und das Gehäuse besteht aus Kunststoff.

Gehäusematerial: Kunststoff

Abdeckungsmaterial: Kunststoff

Kanlux IVIAN LED is a family of downlight type holders. It is characterized by an increased degree of tightness - IP44, which allows using it in bathrooms and rooms with increased humidity. LED SMD diodes are the light source and the casing is made of plastic.

Enclosure material: plastic

Lampshade material: plastic



MAN LED 4,5W W-WW	<b>25780</b>	5905339257802	4,5	weiß   white	430	100	3000
MAN LED 4,5W SN-WW	<b>25781</b>	5905339257819	4,5	Nickel satiniert   nickel satin	410	100	3000
MAN LED 4,5W W-NW	<b>25782</b>	5905339257826	4,5	weiß   white	480	100	4000
MAN LED 4,5W SN-NW	<b>25783</b>	5905339257833	4,5	Nickel satiniert   nickel satin	460	100	4000

[V] 220-240 AC	[Hz] 50	≥25000	15000	ellipse ≤ 6x Nachdem	Ra 80	SMD	☒	□	IP 44
🏠	🌡️ 5+25	🔊	🔌	📏 Ø65	🔌 0,5m	CE	ERC	UK CA	🔄

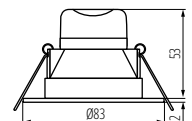

IVIAN LED 4-5W

# TAVO LED

EINBAU-DOWNLIGHT ▶ DOWNLIGHT FITTING



TAVO LED DO 5W-NW



Kanlux TAVO LED ist eine Familie von Unterputz-Downlights. Sie sind in zwei Formen (rund und quadratisch) und in 5 Wattstärken erhältlich - von 5W bis 24W. Die Kanlux TAVO LED-Downlights zeichnen sich durch ein minimalistisches, skandinavisches Design aus. Weitere Vorteile sind die Dichtigkeit nach IP44/20 sowie die Möglichkeit der Aufbaumontage der Modelle 12W und 18W in Kanlux TAVO FRAME Rahmen.

Gehäusematerial: Kunststoff  
Abdeckungsmaterial: Kunststoff

Kanlux TAVO LED is a family of flush-mounted downlights. They are available in two shapes (round and square) and 5 wattages - from 5W to 24W. Kanlux TAVO LED downlights are characterised by a minimalist, Scandinavian design. Additional advantages are their IP44/20 tightness, as well as the possibility of surface mounting the 12W and 18W models in the Kanlux TAVO FRAME.

Enclosure material: plastic  
Lampshade material: plastic

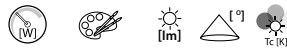

TAVO LED DO 5W-NW	<b>36510</b>	5905339365101	5	weiß   white	400	120	4000
TAVO LED DO 9W-NW	<b>36511</b>	5905339365118	9	weiß   white	900	120	4000
TAVO LED DO 12W-NW	<b>36512</b>	5905339365125	12	weiß   white	1250	120	4000
TAVO LED DO 18W-NW	<b>36513</b>	5905339365132	18	weiß   white	1900	120	4000
TAVO LED DO 24W-NW	<b>36514</b>	5905339365149	24	weiß   white	2600	120	4000
TAVO LED DL 5W-NW	<b>36515</b>	5905339365156	5	weiß   white	400	120	4000
TAVO LED DL 9W-NW	<b>36516</b>	5905339365163	9	weiß   white	900	120	4000
TAVO LED DL 12W-NW	<b>36517</b>	5905339365170	12	weiß   white	1250	120	4000
TAVO LED DL 18W-NW	<b>36518</b>	5905339365187	18	weiß   white	1900	120	4000
TAVO LED DL 24W-NW	<b>36519</b>	5905339365194	24	weiß   white	2600	120	4000

[V]	[Hz]	[h]	[lm]	[Ra]	[SMD]	[IP]
220-240 AC	50	≥15000	25000	≤60 Macadam 80	SMD	44/20
[°C]	[°C]	[lm]	[m]	[m]	[CE]	[UK CA]
5+25	5+25	0,1	0,5m	0,5m	CE	UK CA

## ZUBEHÖR ▶ ACCESSORIES

TAVO FRAME DO 12W	<b>36520</b>	5905339365200	Rahmen für die Aufbaumontage der LED-Downlights Kanlux TAVO.
TAVO FRAME DO 18W	<b>36521</b>	5905339365217	Rahmen für die Aufbaumontage der LED-Downlights Kanlux TAVO.
TAVO FRAME DL 12W	<b>36522</b>	5905339365224	Rahmen für die Aufbaumontage der LED-Downlights Kanlux TAVO.
TAVO FRAME DL 18W	<b>36523</b>	5905339365231	Rahmen für die Aufbaumontage der LED-Downlights Kanlux TAVO.



TAVO FRAME DO 12W



TAVO FRAME DO 18W



TAVO FRAME DL 12W



TAVO FRAME DL 18W

**Kanlux**

# TAVO LED

EINBAU-DOWNLIGHT ► DOWNLIGHT FITTING



TAVO LED DO 5W-NW



TAVO LED DO 9W-NW



TAVO LED DO 12W-NW



TAVO LED DO 18W-NW



TAVO LED DO 24W-NW



TAVO LED DL 5W-NW



TAVO LED DL 9W-NW



TAVO LED DL 12W-NW



TAVO LED DL 18W-NW



TAVO LED DL 24W-NW

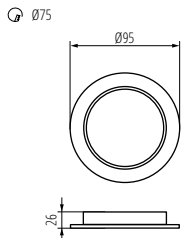

TAVO LED DO 5W-NW

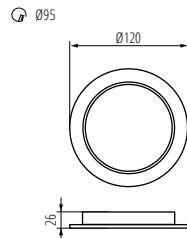

TAVO LED DO 9W-NW

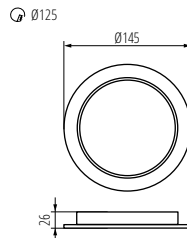

TAVO LED DO 12W-NW

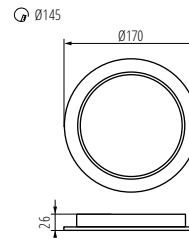

TAVO LED DO 18W-NW

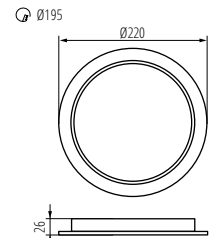

TAVO LED DO 24W-NW

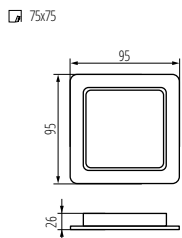

TAVO LED DL 5W-NW

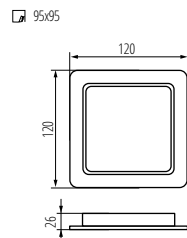

TAVO LED DL 9W-NW

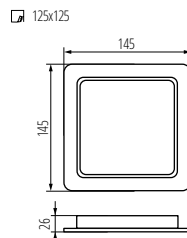

TAVO LED DL 12W-NW

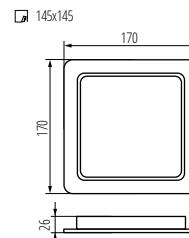

TAVO LED DL 18W-NW

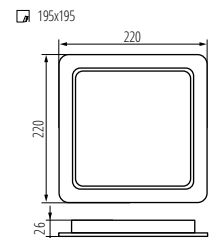

TAVO LED DL 24W-NW





# ROUNDA V2LED

EINBAU-DOWNLIGHT ▶ DOWNLIGHT FITTING



ROUNDA V2LED18W-W

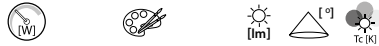

ROUNDA V2LED24W-NW-SN	<b>27220</b>	5905339272201	24	Nickel satiniert   nickel satin	1700	110	4000
ROUNDA V2LED6W-NW-SN	<b>27221</b>	5905339272218	6	Nickel satiniert   nickel satin	300	110	4000
ROUNDA V2LED12W-NW-SR	<b>28930</b>	5905339289308	12	silber   silver	660	110	4000
ROUNDA V2LED12W-NW-W	<b>28931</b>	5905339289315	12	weiß   white	780	110	4000
ROUNDA V2LED12W-WW-W	<b>28932</b>	5905339289322	12	weiß   white	720	110	3000
ROUNDA V2LED18W-NW-SR	<b>28933</b>	5905339289339	18	silber   silver	1080	110	4000
ROUNDA V2LED18W-NW-W	<b>28934</b>	5905339289346	18	weiß   white	1260	110	4000
ROUNDA V2LED18W-WW-W	<b>28935</b>	5905339289353	18	weiß   white	1200	110	3000
ROUNDA V2LED24W-NW-W	<b>28936</b>	5905339289360	24	weiß   white	1680	110	4000
ROUNDA V2LED6W-NW-W	<b>28937</b>	5905339289377	6	weiß   white	330	110	4000
ROUNDA V2LED6W-WW-W	<b>28938</b>	5905339289384	6	weiß   white	300	110	3000
ROUNDA V2LED24W-WW-W	<b>33524</b>	5905339335241	24	weiß   white	1560	110	3000
ROUNDA V2LED6W-WW-B	<b>33562</b>	5905339335623	6	schwarz   black	270	110	3000

[V] 220-240 AC	[Hz] 50	≥20000	(h) 15000	≤6 für Maxdim	Ra 80	SMD	IP 44/20	☰
5+25	☰	☰	(m) 0,05	(mm) 0,75	0,5m	360°	CE	ERC



Kanlux ROUNDA V2LED ist eine neue Version der beliebten runden Downlight-Leuchten für den Innenbereich. Diese Downlights verbinden ästhetisches Design mit LED-Technologie. Die hohe Schutzart IP44 verhindert das Eindringen von Wasser und Staub in die Leuchte.

Gehäusematerial: Aluminiumlegierung  
Abdeckungsmaterial: Kunststoff

Kanlux ROUNDA V2LED is a new version of popular round downlight luminaires for indoor use. The downlights combine aesthetic design with light obtained thanks to LED technology. No water or dust can get to the inside owing to the high class of tightness (IP44).

Enclosure material: aluminum alloy  
Lampshade material: plastic

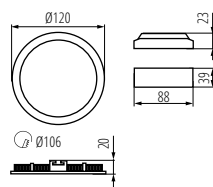

ROUNDA V2LED6W

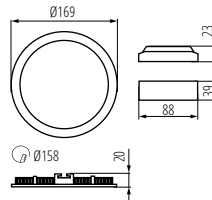

ROUNDA V2LED12W

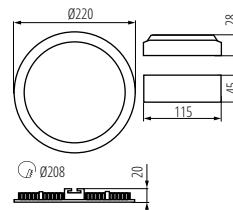

ROUNDA V2LED18W

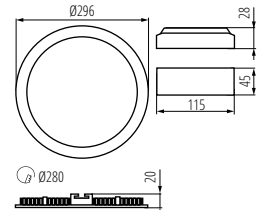

ROUNDA V2LED24W

**Kanlux**

# ROUNDA V2LED

EINBAU-DOWNLIGHT ▶ DOWNLIGHT FITTING



ROUND V2LED6W-W



ROUND V2LED6W-SN



ROUND V2LED6W-SR



ROUND V2LED6W-B



ROUND V2LED12W-W



ROUND V2LED12W-SR



ROUND V2LED18W-W



ROUND V2LED18W-NW-SR



ROUND V2LED24W-W



ROUND V2LED24W-SN



# KATRO V2LED

EINBAU-DOWNLIGHT ► DOWNLIGHT FITTING



KATRO V2LED 18W-W



Model	Article No.	Power [W]	Color	Beam Angle [°]	Height [mm]	Depth [mm]
KATRO V2LED 24W-NW-SN	27216	5905339272164	24 Nickel satiniert   nickel satin	1700	110	4000
KATRO V2LED 12W-NW-SR	28939	5905339289391	12 silber   silver	660	110	4000
KATRO V2LED 12W-NW-W	28940	5905339289407	12 weiß   white	780	110	4000
KATRO V2LED 12W-WW-W	28941	5905339289414	12 weiß   white	720	110	3000
KATRO V2LED 18W-NW-SR	28942	5905339289421	18 silber   silver	1080	110	4000
KATRO V2LED 18W-NW-W	28943	5905339289438	18 weiß   white	1260	110	4000
KATRO V2LED 24W-NW-W	28945	5905339289452	24 weiß   white	1680	110	4000
KATRO V2LED 6W-NW-W	28946	5905339289469	6 weiß   white	330	110	4000

[V] 220-240 AC	[Hz] 50	[Lumen] ≥20000	[h] 15000	[Ra] Ra ≤ 60 MacAdam	[SMD] 80	[IP] IP 44/20	[Temp] 5÷25
[Wattage]	[Beam Angle]	[Beam Diameter]	[Beam Spread]	[Beam Spread]	[Beam Spread]	[Beam Spread]	[Beam Spread]
0,05	0,75	0,5m	360°	CE	ERL	UK CA	



Kanlux KATRO V2LED ist eine neue Version der KATRO N LED-Leuchten - der beliebten quadratischen Downlights für den Innenbereich. Sie verbinden ästhetisches Design mit LED-Technik. Die hohe Schutzart IP44 verhindert das Eindringen von Wasser und Staub in die Leuchte.

Gehäusematerial: Aluminiumlegierung  
Abdeckungsmaterial: Kunststoff

Kanlux KATRO V2LED is a new version of KATRO N LED luminaires, popular square downlights for indoor use. They combine aesthetic design with light obtained owing to LED technology. No water or dust can get to the inside owing to the high class of tightness (IP44).

Enclosure material: aluminum alloy  
Lampshade material: plastic

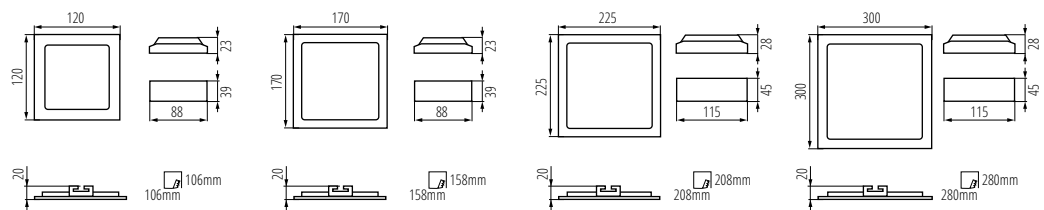

KATRO V2LED 6W

KATRO V2LED 12W

KATRO V2LED 18W

KATRO V2LED 24W

**Kanlux**

# KATRO V2LED

EINBAU-DOWNLIGHT ► DOWNLIGHT FITTING



KATRO V2LED 6W-W



KATRO V2LED 12W-W



KATRO V2LED 12W-SR



KATRO V2LED 18W-W



KATRO V2LED 18W-SR



KATRO V2LED 24W-W



KATRO V2LED 24W-SN



# CARSA V2LED

DECKENLEUCHE ▶ DOWNLIGHT FITTING



CARSA V2LED 24W-NW-W



Kanlux CARSA V2 LED ist eine runde Aufputzleuchte, die sich durch eine harmonische Kombination von LED-Technik mit einer attraktiven und modernen Optik auszeichnet. Sie zeichnet sich durch eine hohe Energieeffizienz bei gleichzeitig hervorragenden Beleuchtungsparametern aus. Kanlux CARSA V2 LED eignet sich ideal für die Beleuchtung von Wohn- und Büroräumen.

Gehäusematerial: Aluminiumlegierung  
Abdeckungsmaterial: Kunststoff

Kanlux CARSA V2 LED is a round façade luminaire characterised by harmonious combination of LED technology with attractive and modern looks. It is distinguished by high energy efficiency with maintained excellent light parameters. Kanlux CARSA V2 LED is perfect for lighting residential interiors and office rooms.

Enclosure material: aluminum alloy  
Lampshade material: plastic



CARSA V2LED 12W-NW-W



CARSA V2LED 18W-NW-W

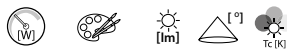

CARSA V2LED 12W-NW-W	<b>28948</b>	5905339289483	12	weiß   white	780	110	4000
CARSA V2LED 18W-NW-W	<b>28949</b>	5905339289490	18	weiß   white	1260	110	4000
CARSA V2LED 24W-NW-W	<b>33541</b>	5905339335418	24	weiß   white	1680	110	4000

[V] 220-240 AC	[Hz] 50	≥20000	15000	dimmbare ≤ für Nachklemm	Ra 80	SMD			IP 20	
5+25			0,05	0,75	0,5m	CE	ERC	UK CA		

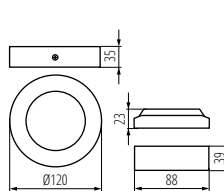

CARSA V2LED 12W

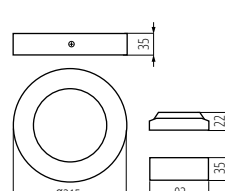

CARSA V2LED 18W

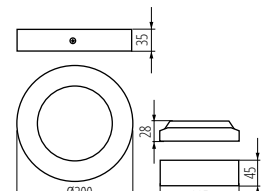

CARSA V2LED 24W

# KANTI V2LED

DECKENLEUCHE ▶ DOWNLIGHT FITTING



KANTI V2LED 18W-SN



KANTI V2LED 12W-W



KANTI V2LED 12W-SN



KANTI V2LED 18W-W



Kanlux KANTI V2 LED ist eine quadratische Aufputzleuchte, die sich durch eine harmonische Kombination moderner Technik mit einer ansprechenden und modernen Optik auszeichnet. Sie zeichnet sich durch eine hohe Energieeffizienz bei gleichzeitig hervorragenden Beleuchtungsparametern aus. Kanlux KANTI V2 LED eignet sich ideal für die Beleuchtung von Wohn- und Büroräumen.

Gehäusematerial: Aluminiumlegierung  
Abdeckungsmaterial: Kunststoff

Kanlux KANTI V2 LED is a square façade luminaire characterised by harmonious combination of modern technology with attractive and modern looks. It is distinguished by high energy efficiency with maintained excellent light parameters. Kanlux KANTI V2 LED is perfect for lighting residential interiors and office rooms.

Enclosure material: aluminum alloy  
Lampshade material: plastic

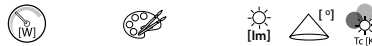

KANTI V2LED 12W-NW-SN	<b>27212</b>	5905339272126	12	Nickel satiniert   nickel satin	720	110	4000
KANTI V2LED 18W-NW-SN	<b>27213</b>	5905339272133	18	Nickel satiniert   nickel satin	1200	110	4000
KANTI V2LED 12W-NW-W	<b>28950</b>	5905339289506	12	weiß   white	780	110	4000
KANTI V2LED 18W-NW-W	<b>28951</b>	5905339289513	18	weiß   white	1260	110	4000

[V]	[Hz]	[h]	[lm]	[mm]	[°]	[K]	[IP]	[°C]
220-240 AC	50	≥20000	15000	≤ 6x MacAdam	80	SMD	IP 20	5+25
[T]	[mm]	[mm]	[mm]	[°]	[CE]	[EAC]	[UK CA]	[Recycle]
	0,05	0,75	0,5m	360° Φ <sub>use</sub>				

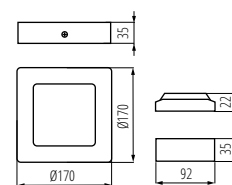

KANTI V2LED 12W

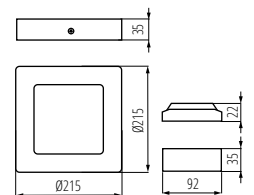

KANTI V2LED 18W

# FL AGOR LED

LED AUSSENSTRAHLER ► LED FLOODLIGHT



FL AGOR LED 100W NW



FL AGOR LED 150W NW



FL AGOR LED 200W NW



FL AGOR/A LED 100W NW



FL AGOR/A LED 150W NW



FL AGOR/A LED 200W NW

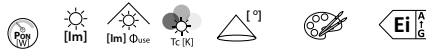

FL AGOR LED 100W NW	<b>33470</b>	5905339334701	100	12000	10800	4000	100	schwarz   black	E
FL AGOR LED 150W NW	<b>33471</b>	5905339334718	150	18000	15300	4000	100	schwarz   black	E
FL AGOR LED 200W NW	<b>33472</b>	5905339334725	200	24000	20300	4000	100	schwarz   black	E
FL AGOR/A LED 100W NW	<b>33473</b>	5905339334732	100	11000	9500	4000	X45\Y80	schwarz   black	F
FL AGOR/A LED 150W NW	<b>33474</b>	5905339334749	150	16500	12400	4000	X45\Y80	schwarz   black	E
FL AGOR/A LED 200W NW	<b>33475</b>	5905339334756	200	22000	17000	4000	X45\Y80	schwarz   black	E

[V] 220-240 AC	[Hz] 50	≥25000	[h] 50000	≤6x Nachlam	Ra 80	SMD	⊕	IP 65	🏠	🌡️ -40+35
🔌	180	🌀	1	1m	⊗	CE	ERC	UK	♻️	

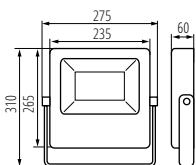

FL AGOR LED 100W  
FL AGOR/A LED 100W

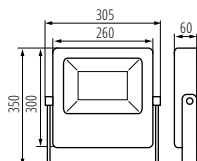

FL AGOR LED 150W  
FL AGOR/A LED 150W

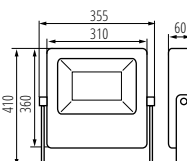

FL AGOR LED 200W  
FL AGOR/A LED 200W



Kanlux AGOR LED ist eine Strahlerserie mit hoher Leistung. Die robuste und langlebige Konstruktion garantiert ein Maß an Schutzart IP65. Kanlux AGOR haben eine symmetrische (AGOR) oder asymmetrische (AGOR/A) Lichtverteilung. Sie können erfolgreich zur Beleuchtung von Sport- oder Industrieflächen, großen Werbeträgern, Lagerhallen und Gebäudefassaden eingesetzt werden.

5 Jahre Garantie gemäß den Bedingungen der Garantieerklärung, die auf der Website verfügbar ist

Gehäusematerial: Aluminiumlegierung  
Material der Schutzscheibe: Hartglas

Kanlux AGOR LED is a series of high-power floodlights. Their solid and durable construction ensures IP65 tightness. Kanlux AGOR floodlights are also symmetrical (AGOR) or asymmetrical light distribution (AGOR/A). You will successfully use them to illuminate sports or industrial areas, large advertising boards, warehouses and building facades. The durability and reliability of Kanlux AGOR floodlights is confirmed by a 5-year warranty.

5 years Warranty under the terms of the warranty statement, available on our website

Enclosure material: aluminum alloy  
Protective glass material: Tempered glass

Kanlux

# FL AGOR HI

LED AUSSENSTRAHLER ▶ LED FLOODLIGHT



FL AGOR HI 240W NW



FL AGOR/A HI 240W NW



FL AGOR HI 300W NW



FL AGOR/A HI 300W NW

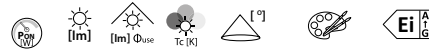

FL AGOR HI 240W NW	<b>33476</b>	5905339334763	240	36000	28800	4000	90	schwarz   black	D
FL AGOR/A HI 240W NW	<b>33477</b>	5905339334770	240	36000	28800	4000	X40°Y90	schwarz   black	D
FL AGOR HI 300W NW	<b>33478</b>	5905339334787	300	45000	36000	4000	90	schwarz   black	D
FL AGOR/A HI 300W NW	<b>33479</b>	5905339334794	300	45000	36000	4000	X40°Y90	schwarz   black	D

[V]	[Hz]	120° Φ <sub>use</sub>	≥50000	50000	±10ppm ≤6x/lockcam	Ra	SMD	⊕	IP	🏠	🌡️
220-240 AC	50					70			65		-20+45
🔧	180	IK	🔌	1mm	1	1m	Hg	CE	EAC	UK	♻️
		08		0,28						CA	

ZUBEHÖR ▶ ACCESSORIES

FL AGOR HI GRID 240W	<b>33482</b>	5905339334824	Schutzgitter für Aussenstrahler FL AGOR HI 300W, FL AGOR HI GRID 300W, schwarz (33482) / Protective grid for floodlight FL AGOR HI 240W, FL AGOR HI GRID 240W, black (33482)						
FL AGOR HI GRID 300W	<b>33483</b>	5905339334831	Schutzgitter für Aussenstrahler FL AGOR HI 300W, FL AGOR HI GRID 300W, schwarz (33483) / Protective grid for floodlight FL AGOR HI 300W, FL AGOR HI GRID 300W, black (33483)						

5+  
**WARRANTY**  
5 years

**SUPER HIGH**  
lumen

up to  
**150 lm/W**

Die Kanlux AGOR HI-Strahler haben zwei hohe Leistungsstufen: 240W und 300W. Diese Scheinwerfer sind in zwei Versionen erhältlich: FL AGOR HI (symmetrisch), FL AGOR/A HI (asymmetrisch), beide mit einer Garantie von 5 Jahren. Kanlux AGOR LED HI ist ein professionelles Produkt mit Überspannungsschutz (6kV), hoher Dichtigkeit (IP 65) und Beständigkeit gegen mechanische Beschädigungen (IK08). Ein weiterer Vorteil ist die sehr hohe Effizienz: bis zu 150lm/W. Die Leuchten sind für die Beleuchtung größerer Industrie-, Gewerbe- und Sport-/Freizeitflächen konzipiert. Als optionales Sicherheitszubehör ist ein Schutzgitter erhältlich.

5 Jahre Garantie gemäß den Bedingungen der Garantieerklärung, die auf der Website verfügbar ist

Gehäusematerial: Aluminiumlegierung  
Material der Schutzscheibe: Hartglas

Kanlux AGOR HI floodlights have two high power options: 240W and 300W. These floodlights are available in two versions: FL AGOR HI (symmetrical), FL AGOR / A HI (asymmetrical) with a 5-year warranty. Kanlux AGOR LED HI is a professional product, we took care of protection against overvoltage (6kV), high tightness (IP 65) and resistance to mechanical damage (IK08). An additional advantage is very high efficiency: up to 150lm / W. Luminaires are designed to illuminate larger industrial, commercial and recreational areas. An additional safety accessory is a protective grid.

5 years Warranty under the terms of the warranty statement, available on our website

Enclosure material: aluminum alloy  
Protective glass material: Tempered glass

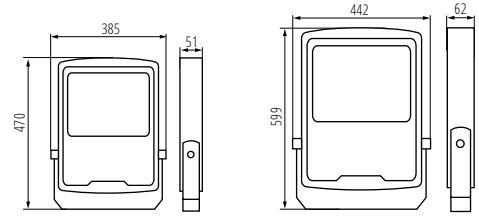

FL AGOR/A HI 240W

FL AGOR/A HI 300W



# IQ-LED FL

LED AUSSENSTRAHLER ▶ LED FLOODLIGHT



IQ-LED FL-30W-NW



5+  
WARRANTY  
5 years

up to  
**120** lm/W

DESIGN  
unique

LED  
technology

LED Außenstrahler Kanlux IQ FL sind ein besonderes Produkt. Ihre automatische Produktion gewährleistet höchste Produktqualität und konstante Lichtparameter. Ihr Vorteil sind auch Marken-LEDs mit einer Lebensdauer von 50000 Stunden. Die Verwendung von Komponenten höchster Qualität führt zu einer fünfjährigen Garantie für die gesamte Serie Kanlux IQ FL.

5 Jahre Garantie gemäß den Bedingungen der Garantieerklärung, die auf der Website verfügbar ist

Gehäusematerial: Metall

Abdeckungsmaterial: Hartglas

Kanlux IQ FL floodlights are unique products. Their automatic production allows ensuring the highest quality and repeatability of lighting parameters. They include brand LEDs with a life span of 50,000 hours, which is also their additional advantage. The use of the highest quality components allows us to provide our customers with a five-year warranty for the whole series of Kanlux IQ FL floodlights.

5 years Warranty under the terms of the warranty statement, available on our website

Enclosure material: Metal

Lampshade material: Tempered glass



IQ-LED FL-10W-NW	<b>33880</b>	5905339338808	10	1200	4000	65	schwarz   black
IQ-LED FL-20W-NW	<b>33881</b>	5905339338815	20	2300	4000	65	schwarz   black
IQ-LED FL-30W-NW	<b>33882</b>	5905339338822	30	3450	4000	65	schwarz   black
IQ-LED FL-50W-NW	<b>33883</b>	5905339338839	50	6000	4000	65	schwarz   black
IQ-LED FL-90W-NW	<b>33884</b>	5905339338846	90	10800	4000	65	schwarz   black
IQ-LED FL-10W-NW-SE	<b>33885</b>	5905339338853	10	1200	4000	44	schwarz   black PIR
IQ-LED FL-20W-NW-SE	<b>33886</b>	5905339338860	20	2300	4000	44	schwarz   black PIR
IQ-LED FL-30W-NW-SE	<b>33887</b>	5905339338877	30	3450	4000	44	schwarz   black PIR
IQ-LED FL-50W-NW-SE	<b>33888</b>	5905339338884	50	6000	4000	44	schwarz   black PIR

[V] 220-240 AC	[Hz] 50	△ 100	⌘ ≥25000	⌚ 50000	⊙ ≤ 6x Nachdäm	☀️ Ra 80	⊠ SMD	⊗ RoHS	⊕ EneC	🏠 IP65
❄️ -30+50	⌘ 180	⌘ 0,3	⌘ 1	⌘ 1m	⊗ Hg	CE	EAC	TÜV	UK CA	

## ZUBEHÖR ▶ ACCESSORIES

IQ-LED FL QC I 3x1MM2	<b>33889</b>	5905339338891	Hermetische Schnellverbindung zum einfachen, schnellen und sicheren Verbinden des Anschlusskabels und des Strahlers. (33889) IQ-LED FL QC I 3x1MM2   Hermetic quick connector for easy, quick and safe connection of the connecting cable and the floodlight, IQ-LED FL QC I 3x1MM2 (33889)
-----------------------	--------------	---------------	---

# IQ-LED FL

LED AUSSENSTRAHLER ► LED FLOODLIGHT



IQ-LED FL-10W-NW



IQ-LED FL-20W-NW



IQ-LED FL-30W-NW



IQ-LED FL-50W-NW



IQ-LED FL-90W-NW



IQ-LED FL-10W-NW-SE



IQ-LED FL-20W-NW-SE



IQ-LED FL-30W-NW-SE



IQ-LED FL-50W-NW-SE

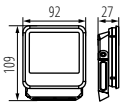

IQ-LED FL-10W-NW

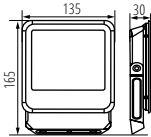

IQ-LED FL-20W-NW

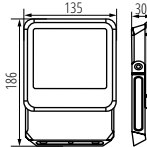

IQ-LED FL-30W-NW

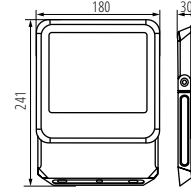

IQ-LED FL-50W-NW

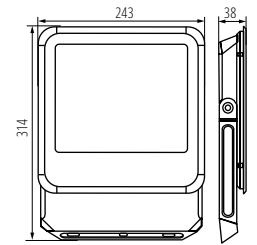

IQ-LED FL-90W-NW

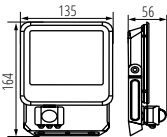

IQ-LED FL-10W-NW-SE

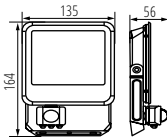

IQ-LED FL-20W-NW-SE

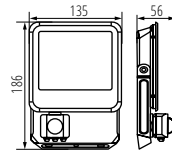

IQ-LED FL-30W-NW-SE

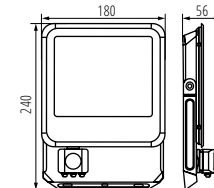

IQ-LED FL-50W-NW-SE



# ANTEM LED

LED AUSSENSTRAHLER ▶ LED FLOODLIGHT



ANTEM LED 10W-NW-SE B



ANTEM LED 20W-NW B



ANTEM LED 30W-NW B



ANTEM LED 50W-NW-SE B



Kanlux ANTEM ist eine Serie von LED-Außenstrahlern. Die LED-Strahler sind in erster Linie einfach anzuschließen, und dank der integrierten Steckklamme vermeiden wir auch unansehnliche Kabelverbindungen. Kanlux ANTEM LED bieten eine breite Palette von Leistungsoptionen an: von 10 W bis 100 W, sowie Versionen mit und ohne Bewegungssensor. Der Opaldiffusor mit einem zarten Prisma streut das Licht sanft und reduziert den Blendeffekt. Die Version ohne Bewegungssensor hat die Schutzart IP65 und die Version mit Bewegungssensor die Schutzart IP44. Der Sensor kann in Bezug auf Leuchtdauer, Lichtintensität und Erfassungsbereich eingestellt werden.

Gehäusematerial: Aluminiumlegierung

Material der Schutzscheibe: Hartglas

Material des Auslegers: Metall

Kanlux ANTEM is a series of LED floodlights. These floodlights are above all easy to connect, and thanks to the integrated junction box you can also avoid unaesthetic cable connections. Kanlux ANTEM LED series provides a wide range of power options, from 10 W to 100 W, as well as versions with and without motion sensors. A milky lampshade with a delicate prism softly disperses light and reduces the glare effect. The version without a motion sensor has a tightness of IP65, while the one with a sensor has a tightness of IP44. The sensor can be adjusted in terms of light duration, light intensity and detection range.

Enclosure material: aluminum alloy

Protective glass material: Tempered glass

Extension-arm material: Metal



Model	Code	Power [W]	Beam angle [°]	Beam diameter [m]	Beam length [m]	Beam diameter [m]	Beam length [m]	Color	Material	Sensor	Protection Class
ANTEM LED 10W-NW B	33200	590533932004	10	800	730	4000	65	schwarz   black		F	
ANTEM LED 20W-NW B	33201	590533932011	20	1600	1510	4000	65	schwarz   black		F	
ANTEM LED 30W-NW B	33202	590533932028	30	2400	2340	4000	65	schwarz   black		F	
ANTEM LED 50W-NW B	33203	590533932035	50	4000	4000	4000	65	schwarz   black		F	
ANTEM LED 100W-NW B	33204	590533932042	100	9500	8300	4000	65	schwarz   black		F	
ANTEM LED 10W-NW-SE B	33205	590533932059	10	800	730	4000	44	schwarz   black	PIR	F	
ANTEM LED 20W-NW-SE B	33206	590533932066	20	1600	1510	4000	44	schwarz   black	PIR	F	
ANTEM LED 30W-NW-SE B	33207	590533932073	30	2400	2340	4000	44	schwarz   black	PIR	F	
ANTEM LED 50W-NW-SE B	33208	590533932080	50	4000	4000	4000	44	schwarz   black	PIR	F	

[V] 220-240 AC	[Hz] 50	120° O <sub>max</sub>	100	≥10000	15000	≤6° MacAdam	80 Ra	SMD			
∗ -20+35	180	1-1,5	1m				CE	EAC	UK		

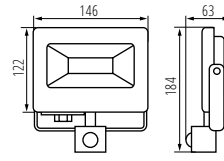

ANTEM LED 30W-NW-SE B

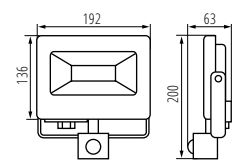

ANTEM LED 50W-NW-SE B

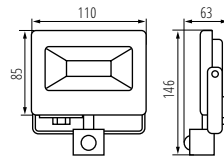

ANTEM LED 10W-NW-SE B

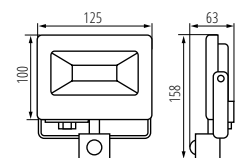

ANTEM LED 20W-NW-SE B

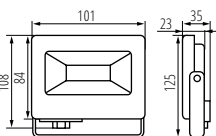

ANTEM LED 10W-NW B

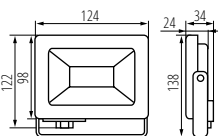

ANTEM LED 20W-NW B

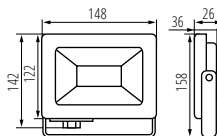

ANTEM LED 30W-NW B

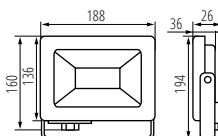

ANTEM LED 50W-NW B

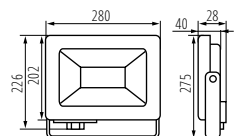

ANTEM LED 100W-NW B

# Kanlux STATO LED

LED AUSSENSTRAHLER ▶ LED FLOODLIGHT



STATO N LED 30W-B



STATO N LED 30W-B



STATO N LED 50W-B

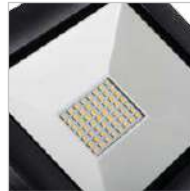

Kanlux STATO N LED ist ein tragbarer Lichtfluter mit hoher Schutzart (IP65). Er wird als Beleuchtung für Renovierungs- oder Bauarbeiten empfohlen. Durch die Regelung des Neigungswinkels des Lichtfluters und des Stativs kann die Oberfläche in vielen Ebenen beleuchtet werden. Ein höherer Farbwiedergabeindex (CRI > 80) als bei den meisten Lichtflutern ermöglicht die Verwendung im Innenbereich (bei Renovierungsarbeiten sind die Farben der beleuchteten Oberfläche besser erkennbar). Im Satz mit Kanlux STATO N LED ist ein 2 Meter langes Kabel mit Stecker enthalten.

Gehäusematerial: Aluminiumlegierung  
Material der Schutzscheibe: Hartglas  
Material des Auslegers: Stahl

Kanlux STATO LED is a portable floodlight with high tightness (IP65). Recommended as lighting during renovations or building works. Adjustment of the inclination angle of the floodlight and the stand allows to additionally light up surface in a lot of planes, higher colour rendering index than most floodlights (CRI=80) is a possibility of using inside rooms (during renovations, colours of lighted surface are better visible). In Kanlux STATO LED the set contains a 2-metre cable with a plug.

Enclosure material: aluminum alloy  
Protective glass material: Tempered glass  
Extension-arm material: steel

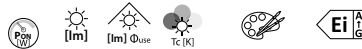

STATO N LED 30W-B	<b>29222</b>	5905339292223	30	3150	2770	4000	schwarz   black	F
STATO N LED 50W-B	<b>29223</b>	5905339292230	50	5250	4430	4000	schwarz   black	F

[V]	[Hz]	$\angle_{\text{use}}$	$\angle$	$\geq 15000$	$\text{lm}$	$\text{lm}$	$\text{Ra}$	SMD	$\oplus$	IP	$\text{m}$
220-240 AC	50	$120^\circ$	120	$\geq 15000$	25000	$\leq \text{für MacAdam}$	80	SMD	$\oplus$	65	$\text{m}$
$\text{°C}$	$\text{°C}$	$\text{°}$	IK	$\text{mm}$	$\text{mm}$	$\text{m}$	$\text{Hg}$	CE	ERL	UK	$\text{m}$
-20+35		330	07	2	1	1m					

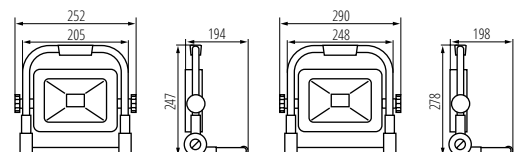

STATO N LED 30W-B

STATO N LED 50W-B

# FL SONE SLR

LED-SOLAR-AUSSENLEUCHE ▶ SOLAR LED LIGHT FITTING

NEW



FL SONE SLR M NW-GR



FL SONE SLR L NW-GR



**IP 65**

**EASY**  
Installation

Die Kanlux FL SONE SLR-Leuchte ist ein solarbetriebener Strahler. Wir können zwischen zwei Stromversorgungslösungen für Flutlicht wählen: 10/100 oder 15/150. Durch die Schutzart IP65 sind sie staubdicht und gegen das Eindringen von Wasser geschützt. Der verstellbare Adapter ermöglicht die getrennte Montage von Leuchte und Solarmodul.

Gehäusematerial: ABS  
Abdeckungsmaterial: Glas

The Kanlux FL SONE SLR fixture is a solar-powered floodlight. We can choose from two floodlight power solutions: 10/100 or 15/150. IP65 makes them dust-proof and protected against water ingress. The adjustable adapter allows for separate installation of the luminaire and solar panel.

Enclosure material: ABS  
Lampshade material: glass

**IP**

FL SONE SLR M NW-GR	<b>36606</b>	5905339366061	10\100	800	4000	65
FL SONE SLR L NW-GR	<b>36607</b>	5905339366078	15\150	1300	4000	65

<b>3,2 DC</b>		<b>90</b>	<b>≥20000</b>	<b>25000</b>	<b>elliptise ≤ 6x MacAdam</b>	
	<b>-10+35</b>					

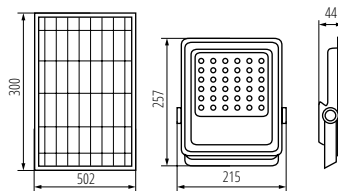

FL SONE SLR M NW-GR

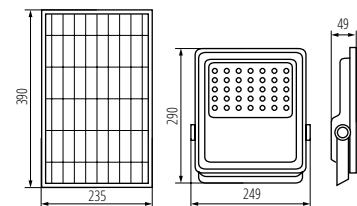

FL SONE SLR L NW-GR

# FL SOLNAR SLR

LED-SOLAR-AUSSENLEUCHTE ► SOLAR LED LIGHT FITTING



FL SOLNAR SLR 8W NW-B

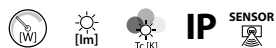

Die Leuchte Kanlux FL SOLNAR ist eine solarbetriebene Leuchte. Die Leistung des Leuchte beträgt 8 W und die Lichtausbeute 100 lm/W (wenn die Leuchte voll aufgeladen ist). Dank der Schutzart IP54 kann die Leuchte bedenkenlos in staubigen und feuchten Umgebungen sowie im Freien in unbedeckten Bereichen montiert werden. Dank des verstellbaren Adapters können die Leuchte und das Solarmodul getrennt voneinander montiert werden. Die Leuchte ist mit einem Bewegungssensor ausgestattet.

Ein 2 Meter langes Verlängerungskabel ist im Set der Leuchte enthalten, damit das Photovoltaik-Panel in gewisser Entfernung von der Leuchte montiert werden kann.

Gehäusematerial: PC

Abdeckungsmaterial: PC

The Kanlux FL SOLNAR luminaire is a solar powered floodlight. The power of the floodlight is 8W, and its luminous efficiency is 100lm/W (when the luminaire is fully charged). IP54 allows you to install the floodlight in conditions of increased dust and moisture, as well as outdoors in places that are not roofed. The adjustable adapter makes it possible to mount the luminaire and the solar panel separately. The floodlight is equipped with a motion sensor.

The luminaire comes complete with a 2m extension cable that allows the installation of a photovoltaic panel at a certain distance from the luminaire.

Enclosure material: PC

Lampshade material: PC

FL SOLNAR SLR 8W NW-B | 36605 | 5905339366054 max 8 max 800 4000 54 PIR

[V] 3,7 DC	≥15000	20000	illigisse s/Gl/Machdam	Ra 80	SMD	
III		-15+35		[m] max 10	[s] - [min] 120	[s] - [min] 10-1
15-1000	max 100	CE	EARC	UK CA		

	 15lx - 1000lx	
1 MODE	—	max 800 lm 10s - 60s
2 MODE Night light	~40 lm	max 800 lm 10s - 60s

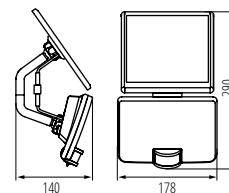

FL SOLNAR SLR 8W NW-B



# STRETON LED

PARKPLATZ-LED-LEUCHTE ► PARKING LIGHTING LED



STRETON LED 20W NW



**5+**  
WARRANTY  
5 years

**IP**  
**65**

**HIGH**  
efficacy

Kanlux STRETON LED sind Außenleuchten für die Beleuchtung von Parkplätzen oder größeren Flächen, die auch nach Einbruch der Dunkelheit gut beleuchtet sein müssen. Dank ihrer Langlebigkeit (50.000 Stunden), ihrer Wasserdichtigkeit (IP65) und ihrer hohen Leistung (bis zu 200 W) sind die Kanlux STRETON LED-Leuchten ideal für städtische Räume, Parkplätze, Sportanlagen oder Plätze.

5 Jahre Garantie gemäß den Bedingungen der Garantieerklärung, die auf der Website verfügbar ist

Gehäusematerial: Aluminiumlegierung

Material der Schutzscheibe: PC

Kanlux STRETON LED are outdoor luminaires designed to illuminate parking lots or larger areas that must be well lit also after dark. Their durability (50,000 hours), tightness (IP65) and high power (up to 200W) make Kanlux STRETON LED a perfect complement to an investment in urban space, in parking lots, in sports facilities or squares.

5 years Warranty under the terms of the warranty statement, available on our website

Enclosure material: aluminum alloy

Protective glass material: PC



STRETON LED 20W NW	<b>36228</b>	5905339362285	20	2800	4000	X140\Y90	grau   grey	D
STRETON LED 40W NW	<b>36229</b>	5905339362292	40	5600	4000	X140\Y90	grau   grey	D
STRETON LED 60W NW	<b>36230</b>	5905339362308	60	8400	4000	X140\Y90	grau   grey	D
STRETON LED 100W NW	<b>36231</b>	5905339362315	100	14000	4000	X140\Y90	grau   grey	D
STRETON LED 150W NW	<b>36232</b>	5905339362322	150	19500	4000	X140\Y90	grau   grey	E
STRETON LED 200W NW	<b>36233</b>	5905339362339	200	26000	4000	X140\Y90	grau   grey	E

<b>[V]</b> 220-240 AC	<b>[Hz]</b> 50	<b>360°</b> Φ <sub>use</sub>	<b>≥20000</b>	<b>50000</b>	<b>≤6</b> Maddiam	<b>Ra</b> 70
<b>SMD</b>	<b>IP</b> 65	<b>IK</b> 08	<b>1</b>	<b>1m</b>	<b>CE</b>	
<b>UK</b> <b>CA</b>						

# STRETON LED

PARKPLATZ-LED-LEUCHTE ▶ PARKING LIGHTING LED



STRETON LED 20W NW



STRETON LED 40W NW



STRETON LED 60W NW



STRETON LED 100W NW



STRETON LED 150W NW



STRETON LED 200W NW

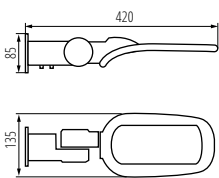

STRETON LED 20W NW

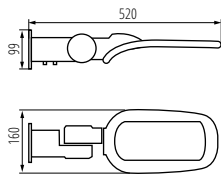

STRETON LED 40W NW

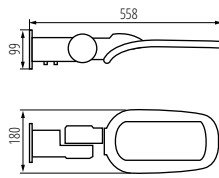

STRETON LED 60W NW

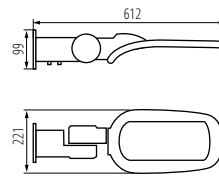

STRETON LED 100W NW

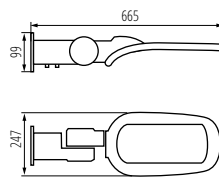

STRETON LED 150W NW

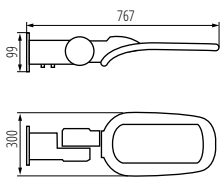

STRETON LED 200W NW





# HB PRO LED HI

LED HALLENTIEFSTRAHLER ► HIGH-BAY LED LIGHT FITTING



HB PRO LED HI 100W-NW



HB PRO LED HI 150W-NW



HB PRO LED HI 200W-NW



HB PRO LED HI 100W-NW	<b>27155</b>	5905339271556	100	14000	4000	schwarz   black
HB PRO LED HI 150W-NW	<b>27156</b>	5905339271563	150	21750	4000	schwarz   black
HB PRO LED HI 200W-NW	<b>27157</b>	5905339271570	200	28000	4000	schwarz   black

[V]	[Hz]	[°]	[h]	[Ra]	[SMD]	[IP]
220-240 AC	50	90	≥15000	30000	≤6x MacKdam	80
[°C]	[IK]	[m]	[CE]	[EAC]	[UK CA]	[Down Arrow]
-20+40	08	1m				



Kanlux HB PRO LED ist eine „High Bay“-Leuchte. Neben der Energieeffizienz, die durch die eingesetzte LED-Technologie gewährleistet wird, zeichnet sie sich durch eine extrem hohe Lebensdauer und eine hohe Schutzart IP65 aus. Ideal für hohe Lager-, Produktions- oder Ladenhallen sowie für moderne Loft-Wohnungen. Ein zusätzlicher Vorteil dieser Leuchten ist eine integrierte Steckklemme, die die Installation erleichtert. Kanlux HB PRO HI bietet auch hohe Lichtströme und eine hohe Effizienz von 150 Lumen/Watt.

5 Jahre Garantie gemäß den Bedingungen der Garantieerklärung, die auf der Website verfügbar ist

Gehäusematerial: Aluminiumlegierung  
Material der Schutzscheibe: Kunststoff

Kanlux HB PRO LED are "High Bay" luminaires. Apart from the energy efficiency of the applied LED technology, they are characterised by high durability and tightness of IP65. It is an excellent choice for high storage, production or shop halls. An additional advantage of these luminaires is an integrated junction box which makes the installation easier. Kanlux HB PRO HI also offers both a high luminous flux and a high luminous efficiency of 150 lm/W.

5 years Warranty under the terms of the warranty statement, available on our website

Enclosure material: aluminum alloy  
Protective glass material: plastic

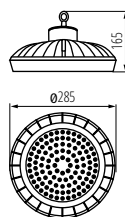

HB PRO LED HI 100W-NW

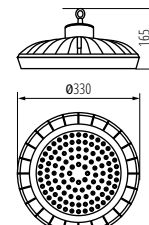

HB PRO LED HI 150W-NW

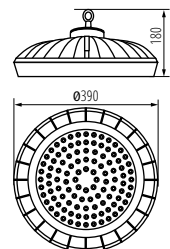

HB PRO LED HI 200W-NW

# HB PRO LED HI

LED HALLENTIEFSTRAHLER ► HIGH-BAY LED LIGHT FITTING



HB PRO LED HI 200W



HBPH LENS 120D 100W



HBPH LENS 120D 150W



HBPH LENS 120D 200W



HBPH LENS 50D 100W



HBPH LENS 50D 150W



HBPH LENS 50D 200W



HBPH GRID 100W



HBPH GRID 150W



HBPH GRID 200W

## ZUBEHÖR ► ACCESSORIES

HBPH LENS 120D 100W	<b>33193</b>	5905339331939	Linse 120 Grad für HB PRO HI 100W, HBPH LENS 120D 100W (33193)   120-degree lens for the HB PRO HI 100W, HBPH LENS 120D 100W light fittings (33193)
HBPH LENS 120D 150W	<b>33194</b>	5905339331946	Linse 120 Grad für HB PRO HI 150W, HBPH LENS 120D 150W (33194)   120-degree lens for the HB PRO HI 150W, HBPH LENS 120D 150W light fittings (33194)
HBPH LENS 120D 200W	<b>33195</b>	5905339331953	Linse 120 Grad für HB PRO HI 200W, HBPH LENS 120D 200W (33195)   120-degree lens for the HB PRO HI 200W, HBPH LENS 120D 200W light fittings (33195)
HBPH LENS 50D 100W	<b>33190</b>	5905339331908	Linse 50 Grad für HB PRO HI 100W, HBPH LENS 50D 100W (33190)   50-degree lens for the HB PRO HI 100W, HBPH LENS 50D 100W light fittings (33190)
HBPH LENS 50D 150W	<b>33191</b>	5905339331915	Linse 50 Grad für HB PRO HI 150W, HBPH LENS 50D 150W (33191)   50-degree lens for the HB PRO HI 150W, HBPH LENS 50D 150W light fittings (33191)
HBPH LENS 50D 200W	<b>33192</b>	5905339331922	Linse 50 Grad für HB PRO HI 200W, HBPH LENS 50D 200W (33192)   50-degree lens for the HB PRO HI 200W, HBPH LENS 50D 200W light fittings (33192)
HBPH GRID 100W	<b>33196</b>	5905339331960	Schutzgitter für HB PRO LED HI 100W-NW, HBPH GRID 100W, silber (33196)   Protective grid for the HB PRO LED HI 100W-NW, HBPH GRID 100W light fittings, silver (33196)
HBPH GRID 150W	<b>33197</b>	5905339331977	Schutzgitter für HB PRO LED HI 150W-NW, HBPH GRID 150W, silber (33197)   Protective grid for the HB PRO LED HI 150W-NW, HBPH GRID 150W light fittings, silver (33197)
HBPH GRID 200W	<b>33198</b>	5905339331984	Schutzgitter für HB PRO LED HI 200W-NW, HBPH GRID 200W, silber (33198)   Protective grid for the HB PRO LED HI 200W-NW, HBPH GRID 200W light fittings, silver (33198)

# REKA LED

WANDLEUCHTE ► FACADE LUMINAIRE



REKA LED EL 7W-L-GR



REKA LED EL 7W-O-GR



REKA LED EL 7W-L-W



REKA LED EL 7W-O-W

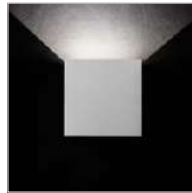
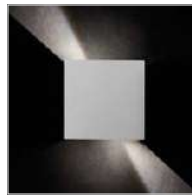
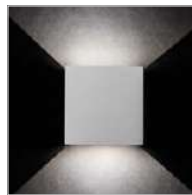

Der Hauptvorteil von Kanlux REKA LED ist der Einsatz von LEDs, die während des Betriebes ihre Helligkeit nicht verlieren. Optisch interessant ist der Lichteffect, den die Leuchte beim Einschalten erzeugt, sowie eine beliebige Einstellung des Ausstrahlwinkels durch die separat einstellbaren Abdeckklappen. Kanlux REKA LED wird für die Fassadenbeleuchtung von Gebäuden eingesetzt.

Einstellung des Abstrahlwinkels

5 Jahre Garantie gemäß den Bedingungen der Garantieerklärung, die auf der Website verfügbar ist

Gehäusematerial: Aluminiumlegierung

Material der Schutzscheibe: Hartglas

The main advantage of Kanlux REKA LED is a visually unique light effect, which we create ourselves after switching on. Thanks to the wings placed at the bottom and top of the luminaire, we can decide on the direction and width of the luminous flux. The Kanlux REKA lamp shines in two directions - up and down - and the luminous flux can be set independently of each other, creating, for example, a perfectly thin line of light at the top, and at the bottom by setting wide light cascades that will flow from the lamp to the ground. Kanlux REKA LED can be used to illuminate the facades of buildings, terraces, balconies or gazebos' external walls.

Beam-angle adjustment

5 years Warranty under the terms of the warranty statement, available on our website

Enclosure material: aluminum alloy

Protective glass material: Tempered glass

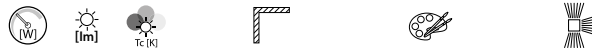

REKA LED EL 7W-L-GR	28990	5905339289902	7	max 360	4000	Wandmontage	wall mounted	graphit   graphite	auf und ab   up and down
REKA LED EL 7W-O-GR	28991	5905339289919	7	max 380	4000	Wandmontage	wall mounted	graphit   graphite	auf und ab   up and down
REKA LED EL 7W-L-W	28992	5905339289926	7	max 500	4000	Wandmontage	wall mounted	weiß   white	auf und ab   up and down
REKA LED EL 7W-O-W	28993	5905339289933	7	max 510	4000	Wandmontage	wall mounted	weiß   white	auf und ab   up and down

[V]	[Hz]	[°]	[h]	[h]	[lm]	Ra	[mm]	[lm]	[°]	[W]
220-240 AC	50	max 90	≥20000	30000	≤ 6x MacAdam	80	1	500	360°	5,3
IP 54	0,5m	-15+35								41
CE	ERC	UK CA								

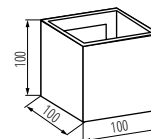

REKA LED EL-L

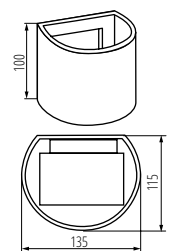

REKA LED EL 7W-O-W

# Kanlux BISO LED

WANDLEUCHE ▶ FACADE LUMINAIRE



BISO LED EL 8W-GR



Kanlux BISO LED sind Fassadenleuchten, die sich durch ein einfaches und ansprechendes Design auszeichnen. Sie können sowohl im Innenraum (sie haben den entsprechenden Ra-Farb-wiedergabeindex) als auch an Gebäudefassaden verwendet werden (IP54). Bei der Kanlux BISO-Leuchte wird das vom LED-Modul kommende Licht sanft auf die Fassade und die Rückseite der Leuchte gestreut.

Gehäusematerial: Aluminiumlegierung

Material der Schutzscheibe: Kunststoff

Kanlux BISO are facade fittings characterized by simple and attractive design. They can be used as a fitting for interiors (they have an appropriate CRI coefficient), at the same time they can be used on building facades (IP54). In Kanlux BISO holder light falling from the LED module is softly diffused on facade and a rear part of the holder.

Enclosure material: aluminum alloy

Protective glass material: plastic



BISO LED EL 8W-GR	<b>29260</b>	5905339292605	8	140	4000	Wandmontage   wall mounted	graphit   graphite
BISO LED EL 8W-W	<b>29261</b>	5905339292612	8	375	4000	Wandmontage   wall mounted	weiß   white

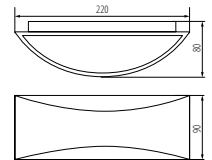

BISO LED EL 8W

[V] 220-240 AC	[Hz] 50	≥25000	(h) 25000	elliptisch ≤ 6x Nachdäm	Ra 80	COB				IP 54
0,5m		-15+40		1,5+2,5	CE	ERC	UK			

# Kanlux GARTO LED

WANDLEUCHE ▶ FACADE LUMINAIRE



GARTO LED EL 8W-GR



Kanlux GARTO sind Fassadenleuchten, die sich durch ein einfaches und ansprechendes Design auszeichnen. Sie können sowohl im Innenraum (sie haben den entsprechenden Ra-Farb-wiedergabeindex) als auch an Gebäudefassaden verwendet werden (IP54). Bei der Kanlux GARTO-Leuchte fällt das Licht auf die Fassade von oben und von unten, und wird gleichmäßig in beide Richtungen gestreut.

Gehäusematerial: Aluminiumlegierung

Material der Schutzscheibe: Kunststoff

Kanlux GARTO are facade fittings characterized by simple and attractive design. They can be used as a fitting for interiors (they have an appropriate CRI coefficient), at the same time they can be used on building facades (IP54). In Kanlux GARTO holder light falls on facade from upwards and from downwards being evenly diffused in both directions.

Enclosure material: aluminum alloy

Protective glass material: plastic



GARTO LED EL 8W-GR	<b>29270</b>	5905339292704	8	300	4000	Wandmontage   wall mounted	graphit   graphite
GARTO LED EL 8W-W	<b>29271</b>	5905339292711	8	350	4000	Wandmontage   wall mounted	weiß   white

[V] 220-240 AC	[Hz] 50	≥25000	(h) 25000	elliptisch ≤ 6x Nachdäm	Ra 80	SMD				IP 54
0,5m		-15+40		1,5+2,5	CE	ERC	UK			

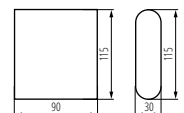

GARTO LED EL 8W

# Kanlux ZEW EL

WANDLEUCHTE ▶ FACADE LUMINAIRE



ZEW EL-235J-B



ZEW EL-235U-B



ZEW EL-235J-GR



ZEW EL-235U-GR



Kanlux ZEW-Leuchten eignen sich hervorragend zur Beleuchtung von Gebäudefassaden unterschiedlicher Art und setzen mit dem nach oben und unten gerichteten Lichtstrahl schöne dekorative Lichtakzente an der Fassade. Die hohe Schutzart IP44 ermöglicht die Montage in Bereichen, die direkt der Witterung ausgesetzt sind.

Gehäusematerial: Aluminiumlegierung  
Material der Schutzscheibe: Hartglas

Kanlux ZEW luminaires are a perfect solution for illuminating facades of buildings of various types, while the light flux directed both upwards and downwards, they create one beautiful decorative light accents on the façade. Owing to the high class of tightness (IP44), the luminaires can be mounted in places directly exposed to weather conditions.

Enclosure material: aluminum alloy  
Protective glass material: Tempered glass



ZEW EL-235J-B	<b>22440</b>	5905339224408	2 x max 35	PAR16	GU10	Wandmontage   wall mounted	schwarz   black	auf und ab   up and down
ZEW EL-235U-B	<b>22441</b>	5905339224415	2 x max 35	PAR16	GU10	Wandmontage   wall mounted	schwarz   black	auf und ab   up and down
ZEW EL-235J-GR	<b>22442</b>	5905339224422	2 x max 35	PAR16	GU10	Wandmontage   wall mounted	grau   grey	auf und ab   up and down
ZEW EL-235U-GR	<b>22443</b>	5905339224439	2 x max 35	PAR16	GU10	Wandmontage   wall mounted	grau   grey	auf und ab   up and down

[V] 220-240 AC	[Hz] 50			<b>IP</b> 44	 0,5m	
 -20+35		 1+2,5	<b>CE</b>	<b>EMC</b>	<b>UK</b>	

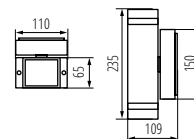

ZEW EL-235J

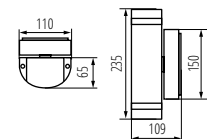

ZEW EL-235U

**Kanlux**

# BART EL

WANDLEUCHTE ► FACADE LUMINAIRE



BART EL-235



Kanlux BART EL ist eine Aufputzleuchte, die sich perfekt sowohl auf die Fassade eines modernen Gebäudes als auch an klassische Bauten passt. Die Schutzart IP54 der Kanlux BART EL Leuchte gewährleistet Witterungsbeständigkeit.

Gehäusematerial: Aluminiumlegierung  
Material der Schutzscheibe: Hartglas

Kanlux BART EL is a façade luminaire which perfectly blends into a modern building and constructions of a more classic style. The rating of tightness (IP54) of Kanlux BART EL luminaire ensures resistance to weather conditions.

Enclosure material: aluminum alloy  
Protective glass material: Tempered glass



BART EL-235 | **07080** | 5905339070807 | 2 x max 35 | PAR16 | GU10 | Wandmontage | wall mounted | grau | grey | auf und ab | up and down

[V] 220-240 AC	[Hz] 50			IP 54	 0,5m	
 -20+35		 1+2,5	CE	ERC	UK CA	

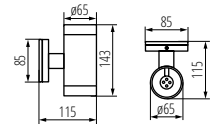

BART EL-235

**Kanlux**

# LART EL

WANDLEUCHTE ► FACADE LUMINAIRE



LART EL-160-GR



LART EL-260-GR



Die Kanlux LART ist eine rohe und klassische Linie von Fassadenleuchten aus Aluminium. Die Außenfläche der Leuchte ist in Graphit ausgeführt. Kanlux LART präsentiert sich sowohl einzeln als auch bei der Installation mehrerer Leuchten perfekt - und ergänzt damit dezent die Lichtgestaltung auf Terrassen oder Gebäudefassaden.

Gehäusematerial: Aluminiumlegierung  
Material der Schutzscheibe: Hartglas

A series of facade Kanlux LART luminaires is a raw and at the same time classic line of facade luminaires in a casing made of aluminium. The external surface of the luminaire is completed in a graphite colour. Kanlux LART look perfect both on a single basis and in combination of several luminaires - subtly complementing light arrangements on terraces or facades of buildings.

Enclosure material: aluminum alloy  
Protective glass material: Tempered glass



LART EL-160-GR | **29832** | 5905339298324 | max 60 | GLS\CFL\LED | E27 | Wandmontage | wall mounted | anthrazit | anthracite | unten | down  
LART EL-260-GR | **29833** | 5905339298331 | 2x max 60 | GLS\CFL\LED | E27 | Wandmontage | wall mounted | anthrazit | anthracite | auf und ab | up and down

[V] 220-240 AC	[Hz] 50			IP 54	 0,5m	
 -20+35		 0,5+1,5	CE	ERC	UK CA	

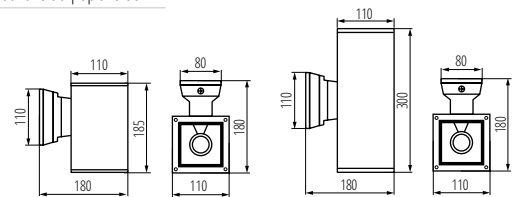

LART EL-160

LART EL-260

# DULI LED

AUSSENLEUCHTE/WANDAUFBAU ► SURFACE-MOUNTED LIGHT FITTING



DULI LED 4W-NW-L-GR



DULI LED 4W-NW-O-GR



DULI LED 6,5W-NW-L-GR



DULI LED 6,5W-NW-O-GR

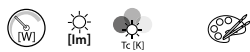

DULI LED 4W-NW-L-GR	<b>33750</b>	5905339337504	4	100	4000	anthrazit   anthracite
DULI LED 4W-NW-O-GR	<b>33751</b>	5905339337511	4	100	4000	anthrazit   anthracite
DULI LED 6,5W-NW-L-GR	<b>33752</b>	5905339337528	6,5	270	4000	anthrazit   anthracite
DULI LED 6,5W-NW-O-GR	<b>33753</b>	5905339337535	6,5	270	4000	anthrazit   anthracite

<b>[V]</b> 220-240 AC	<b>[Hz]</b> 50	<b>IP</b> 54	<b>[h]</b> 30000	<b>80</b>	<b>Ra</b> 80	<b>SMD</b>
		<b>IP</b> 54	0,2m	-15+35		
			<b>CE</b>	<b>ERC</b>	<b>UK</b>	

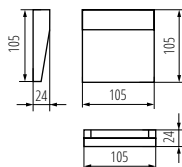

DULI LED 4W-NW-L-GR

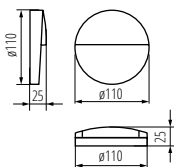

DULI LED 4W-NW-O-GR

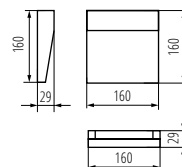

DULI LED 6,5W-NW-L-GR

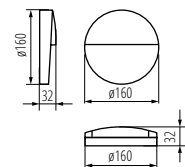

DULI LED 6,5W-NW-O-GR



Kanlux DULI LED ist eine Serie von Fassadenanbauleuchten. Modernes und geometrisches Design in einfacher Form verleihen dieser Serie einen sehr universellen Charakter. Die matte Oberfläche in der Farbe Graphit und die beliebteste Farbtemperatur für Architekturleuchten (4000K) sind ihre weiteren Vorteile. Kanlux DULI LED werden als dekorative Akzentbeleuchtung eingesetzt, um Räume rund um das Gebäude zu beleuchten und zu dekorieren. Kanlux DULI LED-Anbauleuchten werden mit 230 V betrieben, ohne dass ein zusätzliches Netzteil erforderlich ist.

Gehäusematerial: Aluminiumlegierung

Material der Schutzscheibe: PC

Kanlux DULI LED is a series of surface-mounted, façade luminaires. Modern and geometric design in a simple form makes this series very universal. A matte graphite finish and the most popular colour temperature for architectural luminaires (4000K) are other advantages. Kanlux DULI LED is decorative accent lighting that illuminates spaces around the building. Kanlux DULI LED surface-mounted luminaires are powered by 230V without using an additional power supply unit.

Enclosure material: aluminum alloy

Protective glass material: PC

# Kanlux GLASI LED

AUSSENLEUCHTE/WANDEINBAU ► RECESSED LIGHT FITTING



GLASI LED 3W P WW-W



GLASI LED 3W P-GR



GLASI LED 3W P-B



Kanlux GLASI LED ist eine Serie von Einbauleuchten. Die schlichte Form und die drei Farben des Gehäuses (schwarz, Graphit und weiß) machen die Kanlux GLASI LED-Leuchten perfekt für die Beleuchtung von Wänden, Gebäudefassaden und Treppen (sowohl in Wohnungen als auch an öffentlichen Plätzen) und verleihen ihnen einen einzigartigen Charakter.

inklusive Montagedose  
Gehäusematerial: Aluminiumlegierung  
Material der Schutzscheibe: Glas  
Panel-/Rahmenmaterial: PC

Kanlux GLASI LED is a series of wall-mounted light fittings. A simple form in three available colours (black, graphite and white) make Kanlux GLASI LED fittings perfect for illuminating walls, facades of buildings and stairs (both in apartments and public places), giving them a unique character.

Junction box included  
Enclosure material: aluminum alloy  
Protective glass material: glass  
Panel/frame material: PC



GLASI LED 3W P WW-W	<b>33690</b>	5905339336903	3	130	3000	weiß   white
GLASI LED 3W P WW-B	<b>33691</b>	5905339336910	3	130	3000	schwarz   black
GLASI LED 3W P WW-GR	<b>33692</b>	5905339336927	3	130	3000	graphit   graphite
GLASI LED 3W P NW-W	<b>33693</b>	5905339336934	3	140	4000	weiß   white
GLASI LED 3W P NW-B	<b>33694</b>	5905339336941	3	140	4000	schwarz   black
GLASI LED 3W P NW-GR	<b>33695</b>	5905339336958	3	140	4000	graphit   graphite

[V]	[Hz]	[°]	[h]	[lm]	Ra	SMD	[°C]	[mm]	[m]	[m]	[m]	[m]	[m]	[m]	[m]
220-240 AC	50	120	15000	30000	≤ 6x Nachkollam	80	-10 : 35	96x61	CE	ERC	UK CA	IP 44	0,1m		

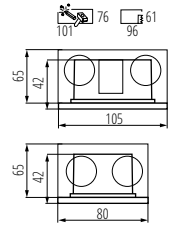

GLASI LED 3W P

# Kanlux TAXI SMD

AUSSENLEUCHTE/WANDEINBAU ► RECESSED LIGHT FITTING



TAXI SMD



TAXI SMD P C/M



Kanlux TAXI SMD ist eine LED-Akzentleuchte. Sie kann sowohl innen, als auch außen (IP54) eingesetzt werden. Es ist eine ideale Lösung für die dekorative Beleuchtung von Treppen oder Treppenabsätzen.

Gehäusematerial: Metall  
Material der Schutzscheibe: Glas  
Panel-/Rahmenmaterial: Edelstahl

Kanlux TAXI SMD is a LED accent luminaire. It can be installed both indoors and outdoors (IP54). A perfect choice for decorative lighting of stairs and platforms.

Enclosure material: Metal  
Protective glass material: glass  
Panel/frame material: stainless steel



TAXI SMD L C/M-NW	<b>26461</b>	5905339264619	0,6	10	4000	Chrom matt   chrome matte
TAXI SMD P C/M-NW	<b>26463</b>	5905339264633	0,6	10	4000	Chrom matt   chrome matte

[V]	[Hz]	[h]	[lm]	Ra	SMD	[°C]	[mm]	[m]	[m]	[m]	[m]	[m]	[m]	[m]	[m]
220-240 AC	50	≥10000	20000	80	80	-20 : 35	0,22	0,75	CE	ERC	UK CA	IP 54	0,1m		

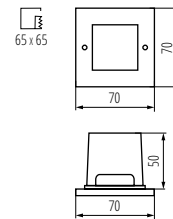

TAXI SMD L

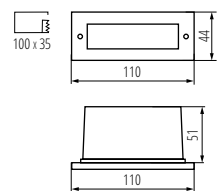

TAXI SMD P



# TURRO LED

BODENEINBAUSTRAHLER ► IN-GROUND LIGHTING FITTING



TURRO LED 3X15W-NW



Kanlux TURRO LED ist eine langlebige Bodeneinbauleuchte mit fest integrierten LED-Modulen. Die Leuchte wird aus Materialien höchster Qualität und mit viel Liebe zum Detail hergestellt. Dank der hohen Schutzart IP67 und der Widerstandsfähigkeit gegen mechanische Beschädigungen IK10 ist die Leuchte perfekt für die Beleuchtung von Einfahrten, Gassen, Gehwegen usw. geeignet. Kanlux TURRO LED hat einen sehr hohen Lichtstrom, so dass sie auch zur Anstrahlung hoher Gebäude, großen Bäumen etc. eingesetzt werden kann.

Gehäusematerial: Aluminiumlegierung

Material der Schutzscheibe: Hartglas

Panel-/Rahmenmaterial: Edelstahl

Kanlux TURRO LED is a durable in-ground luminaire with a non-replaceable light source. The luminaire is made of the highest quality materials and with attention to every detail. Thanks to the high IP67 tightness and resistance to mechanical damage IK10, this luminaire is perfect for illuminating driveways, alleys, sidewalks, etc. Kanlux TURRO LED also has a high luminous flux, so we can also use it in large spaces.

Enclosure material: aluminum alloy

Protective glass material: Tempered glass

Panel/frame material: stainless steel

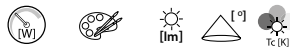

TURRO LED 3X15W-NW | 18983 | 5905339189837 | 45 | silber | silver | 3600 | 40 | 4000

[V] 220-240 AC	[Hz] 50	[h] ≥15000	[h] 30000	light type ≤ for MacAdam 80	Ra 80	COB	IP 67	1m	House icon
[°C] -20+35	[kN] 20	IK 10	[m] 0,5	[mm] 1	lm W 80	CE	ERC	UK CA	Recycling icon

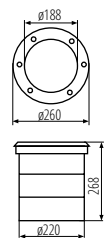

TURRO LED 3X15W-NW

Kanlux

# GORDO N

BODENEINBAUSTRAHLER ► IN-GROUND LIGHTING FITTING



GORDO N 1W CW-L-SR



GORDO N 1W CW-O-SR



Kanlux GORDO LED14 ist eine befahrbare Boden Einbauleuchte mit integriertem LED-Leuchtmittel. Diese aus hochwertigsten Materialien ausgeführte Leuchte weist eine Druckfestigkeit von bis zu 2 Tonnen auf. Schutzart IP-66.

Gehäusematerial: Aluminiumlegierung  
 Material der Schutzscheibe: Hartglas  
 Panel-/Rahmenmaterial: Edelstahl

Kanlux GORDO N is an overrun luminaire with an integrated LED light source for embedding into the ground. It is manufactured of best quality materials owing to which can resist pressure up to 2 tons. The tightness of the luminaire is IP67.

Enclosure material: aluminum alloy  
 Protective glass material: Tempered glass  
 Panel/frame material: stainless steel

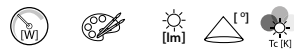

GORDO N 1W CW-L-SR	<b>18192</b>	5905339181923	1	silber   silver	50	80	6500
GORDO N 1W CW-O-SR	<b>18193</b>	5905339181930	1	silber   silver	50	80	6500

[V] 220-240 AC	[Hz] 50	 ≥10000	 20000	 ≤ 6x Max diam	 Ra 80	 SMD	
	IP 67	 0,1m		 -20+35	 IK 08		
 0,2	 0,75		 50				

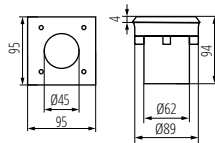

GORDO N 1W CW-L

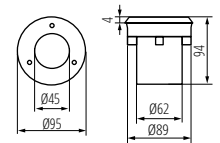

GORDO N 1W CW-O

Kanlux

# ROGER DL

AUSSENLEUCHE/BODENEINBAU ► IN-GROUND FIXTURE



ROGER DL-LED12



ROGER DL-2LED6



Kanlux ROGER DL ist eine Bodeneinbauleuchte mit einem eingebauten LED-Modul. Die spezielle Form des Schirmes verteilt das Licht gleichmäßig, was sich in einem einzigartigen Lichteffect niederschlägt. Die Leuchte zeichnet sich durch eine hohe Schutzart IP66 und Beständigkeit gegen mechanische Beschädigungen IK09 aus.

inklusive Montagdose  
 Gehäusematerial: Stahl  
 Material der Schutzscheibe: Kunststoff  
 Panel-/Rahmenmaterial: Aluminiumlegierung

Kanlux ROGER DL is a ground-recessed luminaire with a built-in LED module. The specific shape of the shade distributes light evenly, which produces a unique light effect. The luminaire has a very high rating of tightness (IP66) and resistance to mechanical damage (IK09).

Junction box included  
 Enclosure material: steel  
 Protective glass material: plastic  
 Panel/frame material: aluminum alloy

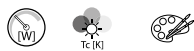

ROGER DL-LED12	<b>07280</b>	5905339072801	1	6000-6500	grau   grey
ROGER DL-2LED6	<b>07281</b>	5905339072818	1	6000-6500	grau   grey

[V] 220-240 AC	[Hz] 50	 20000		IP 66	 0,1m		 -20+35
	IK 09	 0,3	 0,75				

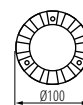

ROGER DL-LED12

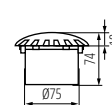

ROGER DL-2LED6

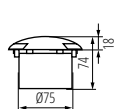
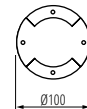

# Kanlux BERG AD

BODENEINBAUSTRALER ► IN-GROUND LIGHTING FITTING



BERG AD-70



Kanlux BERG AD ist eine langlebige Bodeneinbauleuchte für austauschbare Leuchtmittel mit GU10-Sockel. Hervorragend geeignet für die Beleuchtung von Einfahrten, Gassen, Gehwegen usw. Das Modell AD bietet eine Reihe neuer Vorteile, wie z. B. eine doppelte Kabelverschraubung (Möglichkeit der Schleifenverbindung), einen einstellbaren Abstrahlwinkel (360° horizontal und 25° vertikal) und eine sehr hohe Schutzart (IP67, IK10). Die Qualität der Leuchte Kanlux BERG AD wird durch eine fünfjährige Garantie bestätigt.

5 Jahre Garantie gemäß den Bedingungen der Garantieerklärung, die auf der Website verfügbar ist

Gehäusematerial: Aluminiumlegierung, Kunststoff

Material der Schutzscheibe: Hartglas

Panel-/Rahmenmaterial: Edelstahl

Kanlux BERG AD is a durable ground-mounted luminaire with interchangeable light source with GU10 cap. Perfect for illuminating driveways, alleys, walkways, etc. The AD model includes a number of new features such as a double cable gland (possibility of loop connection), adjustable beam angle (360° horizontally and 25° vertically) and very high protection (IP67, IK10). The quality of the Kanlux BERG AD luminaire is confirmed by a five-year warranty.

5 years Warranty under the terms of the warranty statement, available on our website

Enclosure material: aluminum alloy, plastic

Protective glass material: Tempered glass

Panel/frame material: stainless steel



BERG AD-70	<b>36430</b>	5905339364302	max 7	PAR16	GU10	Edelstahl	stainless steel
BERG AD-7L	<b>36431</b>	5905339364319	max 7	PAR16	GU10	Edelstahl	stainless steel

[V] 220-240 AC	[Hz] 50	Light bulb icon	Light bulb icon	Grounding symbol	IP 67	0,5m	House icon	Temperature icon -20+35	25°
[kN] 20	IK 10	Box icon	Dimensions icon 1-1,5	Light beam icon	CE	ERC	UK CA	Down arrow icon	

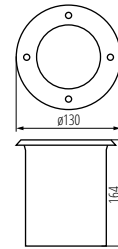

BERG AD-70

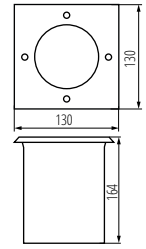

BERG AD-7L

# Kanlux BERG DL

BODENEINBAUSTRALER ► IN-GROUND LIGHTING FITTING



BERG DL-100



Kanlux BERG ist eine langlebige Bodeneinbauleuchte für austauschbare Leuchtmittel mit GU10-Sockel. Sie bewährt sich perfekt für die Hervorhebung von Einfahrten, Gassen, Gehwegen usw. Sie besteht aus hochwertigsten Materialien, wodurch sie eine Druckfestigkeit von bis zu 500 kg aufweist.

inklusive Montagdose

Möglichkeit der Durchgangsversorgung von Leuchten

Einfacher Leuchtmittelwechsel

Gehäusematerial: Stahl

Material der Schutzscheibe: Hartglas

Panel-/Rahmenmaterial: Edelstahl

Kanlux BERG is a durable ground-recessed luminaire using a replaceable light source with an GU10 screw. It works great in illumination of driveways, alleys, sidewalks etc. It is manufactured of best quality materials owing to which can resist pressure up to 500 kg.

Junction box included

optional pass-through connection of light fixtures

easier light source replacement

Enclosure material: steel

Protective glass material: Tempered glass

Panel/frame material: stainless steel



BERG DL-100	<b>07172</b>	5905339071729	max 10	PAR16 LED	GU10	Edelstahl	stainless steel
BERG DL-10L	<b>07173</b>	5905339071736	max 10	PAR16 LED	GU10	Edelstahl	stainless steel

[V] 220-240 AC	[Hz] 50	Light bulb icon	Light bulb icon	Grounding symbol	IP 67	0,5m	House icon	Temperature icon -20+35
[kN] 5	IK 08	Box icon	Dimensions icon 1+2,5	Light beam icon	CE	ERC	UK CA	Down arrow icon

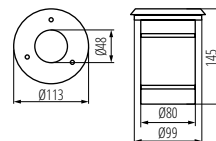

BERG DL-100

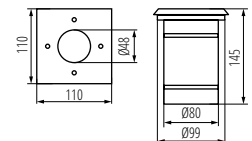

BERG DL-10L

# Kanlux XARD DL

BODENEINBAUSTRALER ► IN-GROUND LIGHTING FITTING



XARD DL-40



XARD DL-40 | 07195 | 5905339071958 max 40 A60 E27 Edelstahl | stainless steel

[V] 220-240 AC	[Hz] 50				IP 67	 0,5m	 -20+35	 20
IK 10		 0,22	 1		CE	ERL	UK CA	



Kanlux XARD DL-Bodeneinbauleuchte zeichnet sich durch die höchste Beständigkeit gegen mechanische Beschädigungen aus - IK10-Schutz - Schutz gegen Vandalismus.

inklusive Montagedose  
Gesamtlänge der Leuchtmittel max 110mm  
Gehäusematerial: Aluminiumlegierung  
Material der Schutzscheibe: Hartglas  
Panel-/Rahmenmaterial: Edelstahl

Kanlux XARD ground recessed luminaire is characterised by the highest level of resistance to mechanical damage - the so-called "vandal-resistance" - IK10. Add to this a high rating of tightness (IP67) and we get a luminaire which is a great solution for lighting facades of buildings, squares, terraces, parks, paths, passages, driveways, stairs, etc.

Junction box included  
total light source length max 110 mm  
Enclosure material: aluminum alloy  
Protective glass material: Tempered glass  
Panel/frame material: stainless steel

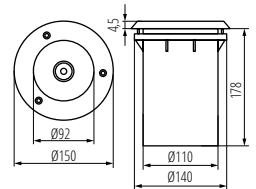

XARD DL-40

# Kanlux MORO N

BODENEINBAUSTRALER ► IN-GROUND LIGHTING FITTING



MORO N IG-20



MORO N IG-20 | 18194 | 5905339181947 max 20 PAR16 GU10 Edelstahl | stainless steel

[V] 220-240 AC	[Hz] 50				IP 67	 0,5m	 -20+35	 20	IK 08
	 3x1			CE	ERL	UK CA			



Kanlux MORO DL ist eine langlebige Bodeneinbauleuchte für austauschbare Leuchtmittel mit GU10-Sockel (max.20W), die für die Beleuchtung von Einfahrten, Gassen, Gehwegen usw. eingesetzt wird. Sie besteht aus hochwertigen Materialien, wodurch sie eine Druckfestigkeit von 20 kN aufweist. Weitere Vorteile sind die Wasserdichtigkeit nach IP67 und die Beständigkeit gegen mechanische Beschädigungen nach IK08.

Gehäusematerial: Aluminiumlegierung  
Material der Schutzscheibe: Hartglas  
Panel-/Rahmenmaterial: Edelstahl

Kanlux MORO N is a durable in-ground luminaire with a replaceable light source with GU10 cap (max.20W). You can successfully use it to illuminate driveways, alleys, sidewalks or plants in the garden. It is manufactured of best quality materials owing to which can resist pressure up to 2 tons. Its additional advantages is high rating of tightness (IP67) and (IK08) resistance to mechanical damage.

Enclosure material: aluminum alloy  
Protective glass material: Tempered glass  
Panel/frame material: stainless steel

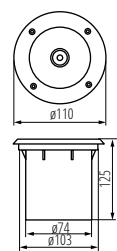

MORO N IG-20



# ABETE LED

LED-AUSSENLEUCHTE ► LED GARDEN LIGHTING FIXTURE

NEW



ABETE LED 60 GR



ABETE LED 80 GR



ABETE LED EL 20 GR



ABETE LED EL 20 SE-GR



ABETE LED 60 GR	<b>36570</b>	5905339365705	7	540	4000	graphit   graphite	Bodenmontage   On the floor
ABETE LED 80 GR	<b>36571</b>	5905339365712	7	540	4000	graphit   graphite	Bodenmontage   On the floor
ABETE LED EL 20 GR	<b>36572</b>	5905339365729	7	540	4000	graphit   graphite	Wandmontage   wall mounted
ABETE LED EL 20 SE-GR	<b>36573</b>	5905339365736	7	540	4000	graphit   graphite	Wandmontage   wall mounted PIR

[V] 220-240 AC	[Hz] 50	≥15000	30000	ellipse ≤ 6x MacAdam	Ra 80	SMD
⊗	⊕	<b>IP</b> 44	⌚	⊖	⊕	0,2m
lm W 77	CE	EAC	UK CA	⌚		

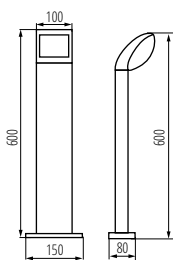

ABETE LED 60 GR

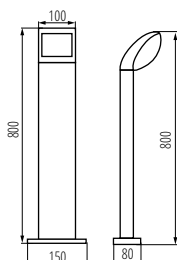

ABETE LED 80 GR

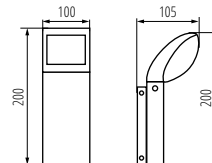

ABETE LED EL 20 GR

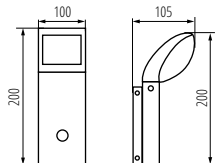

ABETE LED EL 20 SE-GR



Kanlux ABETE Außenleuchten sind für diejenigen, die klassischen Stil und Einfachheit zu schätzen wissen. Zwei Pollerleuchten mit einer Höhe von 60 und 80 cm und zwei Wandleuchten (darunter eine mit einem Bewegungssensor - SE) sind ein universelles und funktionelles Design. Das elegante, schlanke Design und der milchige Kunststoffdiffuser ermöglichen einen breiten und universellen Einsatz der Kanlux ABETE-Leuchten sowohl in privaten Gärten als auch in gewerblichen Projekten.

Gehäusematerial: Aluminiumlegierung  
Abdeckungsmaterial: Kunststoff

Kanlux ABETE outdoor luminaires are recommended for those who appreciate classic style and simplicity. Two posts with a height of 60 and 80 cm and two wall-mounted luminaires (including one with a motion sensor - SE) are a universal and functional design. The elegant, slender design and the milky plastic light diffuser enable wide and universal use of Kanlux ABETE luminaires both in private gardens and commercial projects.

Enclosure material: aluminum alloy  
Lampshade material: plastic

# Kanlux PEVO

AUSSENLEUCHE FÜR AUSTAUSCHBARE LEUCHTMITTEL  
▶ GARDEN LIGHT FITTING WITH REPLACEABLE LIGHT SOURCE

NEW



PEVO 80 GR



PEVO 50 GR



PEVO EL 25 GR

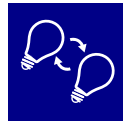

Kanlux PEVO ist eine Außenbeleuchtung mit einer stabilen und soliden Konstruktion. Diese Leuchten sind ideal für Gärten mit niedriger Vegetation. Sie wurden für Fußgängerzonen, Alleen und Grünflächen neben Wohnhäusern entworfen. Sowohl die Poller- als auch die Wandleuchten Kanlux PEVO bieten eine interessante, unaufdringliche Lichtwirkung. Die Leuchten sind an austauschbare Leuchtmittel mit einem GX53-Sockel angepasst, durch deren Verwendung die Leuchte einen einzigartigen Charakter erhält und wie eine integrierte Quelle wirkt.

Gehäusematerial: Aluminiumlegierung  
Abdeckungsmaterial: PC

Kanlux PEVO is outdoor lighting with a stable and solid construction. Those luminaires are ideal for gardens with low vegetation. They were designed for walking areas, alleys and green areas next to apartment buildings. Both the posts and the wall-mounted Kanlux PEVO luminaires give an interesting, unobtrusive lighting effect. The luminaires are adapted to replaceable light sources with a GX53 base, thanks to their use, the luminaire gains a unique character and looks like an integrated source.

Enclosure material: aluminum alloy  
Lampshade material: PC

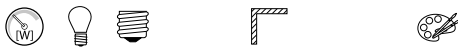

PEVO 80 GR	36550	5905339365507	max 11	LED	GX53	Bodenmontage   surface mounted	graphit   graphite
PEVO 50 GR	36551	5905339365514	max 11	LED	GX53	Bodenmontage   surface mounted	graphit   graphite
PEVO EL 25 GR	36552	5905339365521	max 11	LED	GX53	Wandmontage   wall mounted	graphit   graphite

<b>[V]</b> 220-240 AC	<b>[Hz]</b> 50				<b>IP</b> 44		 -20+35
	 1,5	 0,5m					

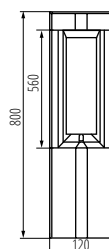

PEVO 80 GR

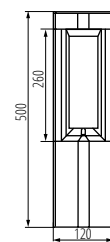

PEVO 50 GR

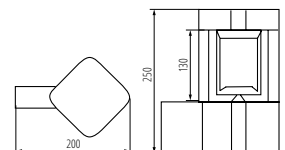

PEVO EL 25 GR

# LAVEN

AUSSENLEUCHTE FÜR AUSTAUSCHBARE LEUCHTMITTEL  
 ► GARDEN LIGHT FITTING WITH REPLACEABLE LIGHT SOURCE



Kanlux LAVEN ist eine außergewöhnlich elegante Außenbeleuchtung. Diese Gartenlampen haben ein einzigartiges Design, das auf einem geräucherten Lampenschirm basiert, der mit dem Rest der Leuchte durch ein diagonales Seil verbunden ist. Ihr einzigartiger Stil wird durch LED-Leuchtmittel mit Glühfaden unterstrichen - vor allem in einer warmen Farbe. Der Flansch an der Basis der Kanlux LAVEN Pfosten erleichtert die Befestigung der Leuchte am Boden. In der Familie dieser Leuchten gibt es zwei Pollerleuchten: 50 und 80 cm, und zwei Wandleuchten, von denen eine (SE) einen eingebauten Bewegungs- und Dämmerungssensor hat.

Gehäusematerial: Aluminiumlegierung  
 Abdeckungsmaterial: PC

Kanlux LAVEN is exceptionally elegant outdoor lighting. Those garden lamps are a unique design based on a smoked lampshade connected to the rest of the luminaire with a diagonal rope. Their unique style is emphasised by filament LED light sources - especially in a warm colour. The flange at the base of the Kanlux LAVEN posts makes it easier to fix the lamp in the ground. In the family of those luminaires, there are two posts: 50 and 80 cm, and two wall-mounted luminaires, one of which (SE) has a built-in motion and twilight sensor.

Enclosure material: aluminum alloy  
 Lampshade material: PC



LAVEN 80 GR	<b>36545</b>	5905339365453	max 10	LED	E27	Bodenmontage   surface mounted	graphit   graphite
LAVEN 50 GR	<b>36546</b>	5905339365460	max 10	LED	E27	Bodenmontage   surface mounted	graphit   graphite
LAVEN EL 28 SE-GR	<b>36547</b>	5905339365477	max 10	LED	E27	Wandmontage   wall mounted	graphit   graphite PIR
LAVEN EL 25 GR	<b>36548</b>	5905339365484	max 10	LED	E27	Wandmontage   wall mounted	graphit   graphite

<b>[V]</b> 220-240 AC	<b>[Hz]</b> 50				<b>IP</b> 44		
	0,5-1		0,2m	<b>CE</b>	<b>EAC</b>	<b>UK</b> <b>CA</b>	

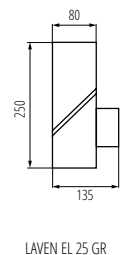
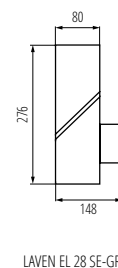
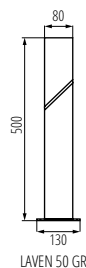
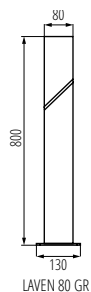



# Kanlux PRESO

AUSSENLEUCHTE FÜR AUSTAUSCHBARE LEUCHTMITTEL  
▶ GARDEN LIGHT FITTING WITH REPLACEABLE LIGHT SOURCE

NEW



PRESO 80 GR



PRESO 50 GR



PRESO 30 GR



PRESO EL 18 GR



PRESO 80 GR	<b>36540</b>	5905339365408	max 10	LED	E27	Bodenmontage   surface mounted	graphit   graphite
PRESO 50 GR	<b>36541</b>	5905339365415	max 10	LED	E27	Bodenmontage   surface mounted	graphit   graphite
PRESO 30 GR	<b>36542</b>	5905339365422	max 10	LED	E27	Bodenmontage   surface mounted	graphit   graphite
PRESO EL 18 GR	<b>36543</b>	5905339365439	max 10	LED	E27	Wandmontage   wall mounted	graphit   graphite

[V] 220-240 AC	[Hz] 50				<b>IP</b> 44		 -20+35
	 1,5	 0,5m					

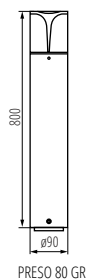

PRESO 80 GR



PRESO 50 GR

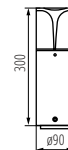

PRESO 30 GR

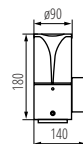

PRESO EL 18 GR



Kanlux PRESO ist eine Familie von 4 Gartenleuchten, darunter drei Säulen mit Höhen von 30 bis 80 cm, deren perfekte Ergänzung eine Wandleuchte ist. Dank des speziellen Designs strahlen die Lampen seitlich statt nach oben, was eine gute Ausleuchtung der gewünschten Bereiche ermöglicht. Das profilierte Design des Lampenschirms verhindert, dass Wasser auf der Oberfläche der Leuchte stehen bleibt. Die gesamte Serie der Gartenleuchten Kanlux PRESO ist an austauschbare Leuchtmittel mit E27-Sockel angepasst, so dass wir die entsprechende Lichtintensität und -farbe selbst wählen können.

Gehäusematerial: Aluminiumlegierung  
Abdeckungsmaterial: PC

Kanlux PRESO is a family of 4 garden luminaires, among which there are three posts with heights from 30 to 80 cm, and their perfect complement is a wall-mounted luminaire. Thanks to the special design, the lamps shine sideways instead of upwards, which enables illuminating the desired areas properly. The profiled design of the lampshade prevents water from staying on the surface of the lamp. The whole series of Kanlux PRESO garden luminaires is adapted to replaceable light sources with an E27 base so we can choose the appropriate intensity and colour of light ourselves.

Enclosure material: aluminum alloy  
Lampshade material: PC

# Kanlux SELTO

AUSSENLEUCHTE FÜR AUSTAUSCHBARE LEUCHTMITTEL  
▶ GARDEN LIGHT FITTING WITH REPLACEABLE LIGHT SOURCE

NEW



SELTO 80 B



SELTO 50 B



SELTO EL 23 B



Die Gartenleuchten Kanlux SELTO sind schlichte, moderne Formen, die in Metall- und Glasgehäusen untergebracht sind. Dank ihrer Form eignen sie sich sowohl für klassische Gärten als auch für solche, die vom asiatischen Stil inspiriert sind (ähnlich einer Pagode). Die zusätzliche Funktionalität in Form eines Flansches an der Basis ermöglicht eine einfache Befestigung der Kanlux SELTO-Leuchten am Boden. Die Leuchten sind an Leuchtmittel mit einem E27-Sockel angepasst.



Gehäusematerial: Edelstahl  
Abdeckungsmaterial: Glas

Kanlux SELTO garden luminaires are simple, modern forms placed inside metal and glass casings. Thanks to their shapes, they are perfect for classic gardens as well as those inspired by the Asian style (resembling a pagoda), additional functionality in the form of a flange at the base enables easy mounting of Kanlux SELTO luminaires to the ground. The luminaires are adapted to light sources with an E27 base.

Enclosure material: stainless steel  
Lampshade material: glass



SELTO 80 B	<b>36555</b>	5905339365552	max 15	LED	E27	Bodenmontage   surface mounted	schwarz   black
SELTO 50 B	<b>36556</b>	5905339365569	max 15	LED	E27	Bodenmontage   surface mounted	schwarz   black
SELTO EL 23 B	<b>36557</b>	5905339365576	max 15	LED	E27	Wandmontage   wall mounted	schwarz   black

<b>[V]</b> 220-240 AC	<b>[Hz]</b> 50				<b>IP</b> 44		<b>-20+35</b>
	1,5	0,5m					

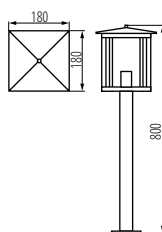

SELTO 80 B

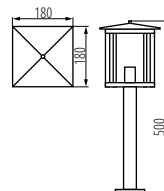

SELTO 50 B

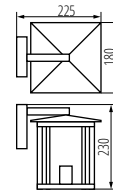

SELTO EL 23 B

# Kanlux LIEGO

AUSSENLEUCHE FÜR AUSTAUSCHBARE LEUCHTMITTEL  
▶ GARDEN LIGHT FITTING WITH REPLACEABLE LIGHT SOURCE

NEW



LIEGO 97 B



LIEGO 89 PEND B



LIEGO EL 28 UP B



LIEGO EL 28 UP SE B



LIEGO 37 B

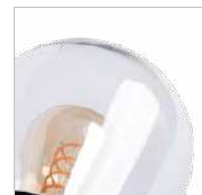

Die Kanlux LIEGO Gartenleuchten sind beeindruckende ovale Lampenschirme aus Glas, in die dekorative LED-Leuchtmittel eingesetzt werden können. Diese stellen eine zusätzliche Dekoration für die Beleuchtung des Gartens dar. Sie können nicht nur zur Beleuchtung eines Gartens, sondern auch von Pavillons, Terrassen und Innenhöfen verwendet werden, während die Wandleuchten erfolgreich Balkone beleuchten. In der gesamten Familie (Pendelleuchte, Pollerleuchte, Wandleuchte) können austauschbare LED-Leuchtmittel mit E27-Sockel verwendet werden.

Gehäusematerial: Aluminiumlegierung  
Abdeckungsmaterial: Glas

Kanlux LIEGO garden luminaires are impressive oval-shaped glass lampshades, with which it is possible to use decorative LED filaments that can be an additional decoration illuminating the garden. They can be used not only to light a garden but also gazebos, terraces and patios, while the wall-mounted luminaires successfully illuminate balconies. In the whole family (pendant lamp, posts, wall-mounted), it is possible to use replaceable LED light sources with an E27 base.

Enclosure material: aluminum alloy  
Lampshade material: glass

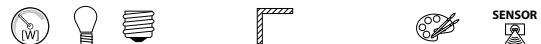

LIEGO 97 B	<b>36530</b>	5905339365309	max 15	LED	E27	Bodenmontage   surface mounted	schwarz   black
LIEGO 89 PEND B	<b>36531</b>	5905339365316	max 15	LED	E27	Deckenmontage   ceiling mounted	schwarz   black
LIEGO EL 28 UP B	<b>36532</b>	5905339365323	max 15	LED	E27	Wandmontage   wall mounted	schwarz   black
LIEGO EL 28 UP SE B	<b>36533</b>	5905339365330	max 15	LED	E27	Wandmontage   wall mounted	schwarz   black PIR
LIEGO 37 B	<b>36534</b>	5905339365347	max 15	LED	E27	Bodenmontage   surface mounted	schwarz   black

[V] 220-240 AC	[Hz] 50				IP 44		 -20+35
	 1,5	 0,5m	CE	ERC	UK CA		

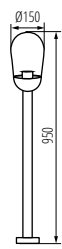

LIEGO 97 B

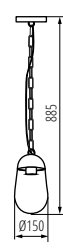

LIEGO 89 PEND B

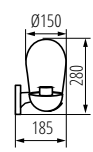

LIEGO EL 28 UP B

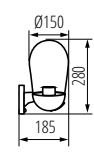

LIEGO EL 28 UP SE B

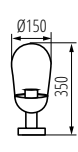

LIEGO 37 B

# Kanlux VIMO

AUSSENLEUCHTE FÜR AUSTAUSCHBARE LEUCHTMITTEL  
► GARDEN LIGHT FITTING WITH REPLACEABLE LIGHT SOURCE



VIMO EL 27 SE-B



VIMO EL 27 BR; SE



VIMO 50 B; SE



VIMO 50 BR; SE



VIMO 80 B



VIMO 80 BR



Die Kanlux VIMO-Leuchterserie zeichnet sich durch eine einzigartige Form aus, die an eine Laterne erinnert. Diese Gartenleuchten mit austauschbarem Leuchtmittel sind in zwei Farben erhältlich: mattes Schwarz und Bronze (Rostbraun). Kanlux VIMO ist erhältlich in zwei Größen als Stehleuchte und einer Wandleuchte, einschließlich einer Version mit Bewegungsmelder. Diese unkonventionelle Form und die Dichtheitsklasse IP44 schaffen Kanlux VIMO Lampen in jedem Garten oder Haus eine schöne Atmosphäre.

Gehäusematerial: Aluminiumlegierung

Abdeckungsmaterial: PC

Kanlux VIMO luminaires series is characterised by a unique shape bringing to mind lanterns. These garden lamps with a replaceable light source are available in two colours: matte black and bronze (copper). Kanlux VIMO consists of two sizes of posts and a wall lamp, including a version with a motion sensor. This unconventional shape and IP44 tightness class will make Kanlux VIMO lamps look great in every garden or house environment.

Enclosure material: aluminum alloy

Lampshade material: PC

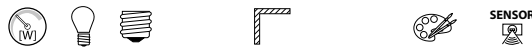

Model	Article No.	Part No.	Max. Height	Light Type	Base	Mounting	Colors	Sensor
VIMO EL 27 B	34980	5905339349804	max 15	LED	E27	Wandmontage   wall mounted	schwarz   black	
VIMO EL 27 BR	34981	5905339349811	max 15	LED	E27	Wandmontage   wall mounted	braun   brown	
VIMO EL 27 SE-B	34982	5905339349828	max 15	LED	E27	Wandmontage   wall mounted	schwarz   black	PIR
VIMO EL 27 SE-BR	34983	5905339349835	max 15	LED	E27	Wandmontage   wall mounted	braun   brown	PIR
VIMO 50 B	34984	5905339349842	max 15	LED	E27	Bodenmontage   surface mounted	schwarz   black	
VIMO 50 BR	34985	5905339349859	max 15	LED	E27	Bodenmontage   surface mounted	braun   brown	
VIMO 50 SE-B	34986	5905339349866	max 15	LED	E27	Bodenmontage   surface mounted	schwarz   black	PIR
VIMO 50 SE-BR	34987	5905339349873	max 15	LED	E27	Bodenmontage   surface mounted	braun   brown	PIR
VIMO 80 B	34988	5905339349880	max 15	LED	E27	Bodenmontage   surface mounted	schwarz   black	
VIMO 80 BR	34989	5905339349897	max 15	LED	E27	Bodenmontage   surface mounted	braun   brown	

<b>[V]</b> 220-240 AC	<b>[Hz]</b> 50				<b>IP</b> 44		 -20+40
	 1,5+2,5	 0,5m	<b>CE</b>	<b>ERC</b>	<b>UK</b> <b>CA</b>		

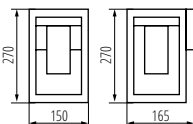

VIMO EL 27

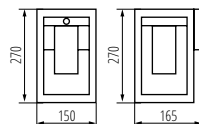

VIMO EL 27 SE

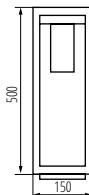

VIMO 50

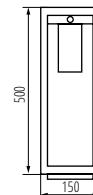

VIMO 50 SE

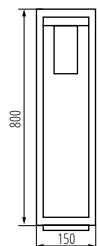

VIMO 80

# Kanlux GORI

AUSSENLEUCHE FÜR AUSTAUSCHBARE LEUCHTMITTEL  
▶ GARDEN LIGHT FITTING WITH REPLACEABLE LIGHT SOURCE



GORI EL 235 D



GORI EL 235 D



GORI 50



GORI 80



GORI EL 135 D	<b>29000</b>	5905339290007	max 35	PAR16	GU10	unten   down	anthrazit   anthracite
GORI EL 235 D	<b>29001</b>	5905339290014	2 x max 35	PAR16	GU10	auf und ab   up and down	anthrazit   anthracite
GORI 50	<b>29002</b>	5905339290021	max 35	PAR16	GU10	unten   down	anthrazit   anthracite
GORI 80	<b>29003</b>	5905339290038	max 35	PAR16	GU10	unten   down	anthrazit   anthracite

[V] 220-240 AC	[Hz] 50			<b>IP</b> 44		 -20/+35
	 1+2,5	 0,5m	<b>CE</b>	<b>ERAC</b>	<b>UK</b> <b>CA</b>	

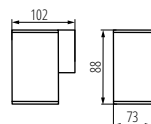

GORI EL 135

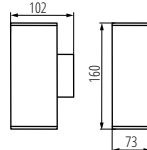

GORI EL 235

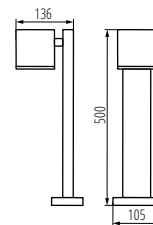

GORI 50

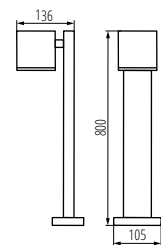

GORI 80



Gartenleuchten Kanlux GORI ist eine komplette Serie, die aus Wandlampen und Pollerleuchten besteht. Ihre quadratische, strenge Form ist die Antwort auf Markttrends. Alle Kanlux GORI-Leuchten sind für austauschbare Leuchtmittel ausgestattet, was die freie Wahl der Farbe und Intensität der Hausbeleuchtung ermöglicht.

Gehäusematerial: Aluminiumlegierung  
Material der Schutzscheibe: Hartglas

Kanlux GORI garden fixtures are a complete range, they consist of wall lamps and posts. Their square, austere shape is a direct response to market trends. All Kanlux GORI fixtures are equipped with replaceable light sources which give the possibility of a free choice of light colour and intensity around the house.

Enclosure material: aluminum alloy  
Protective glass material: Tempered glass

# Kanlux VADRA

AUSSENLEUCHTE FÜR AUSTAUSCHBARE LEUCHTMITTEL  
▶ GARDEN LIGHT FITTING WITH REPLACEABLE LIGHT SOURCE



VADRA 21L-UP SE



VADRA 16L-UP



VADRA 50



VADRA 80



Die Aussenleuchten Kanlux VADRA sind für die Wandmontage (Wandleuchten) oder auf festem Untergrund (Bodenmontage) konzipiert. Kanlux VADRA sind für austauschbare Leuchtmittel ausgestattet, was die freie Wahl der Farbe und Intensität der Hausbeleuchtung ermöglicht.

Maximale Höhe der Leuchtmittel 110mm

Gehäusematerial: Aluminiumlegierung  
Abdeckungsmaterial: Kunststoff

External Kanlux VADRA fixtures are designed for wall mounting (wall lamps) or on solid ground (posts). Kanlux VADRA are equipped with replaceable light sources which give the possibility of a free choice of light colour and intensity around the house.

Maximum light-source height 110mm  
Enclosure material: aluminum alloy  
Lampshade material: plastic

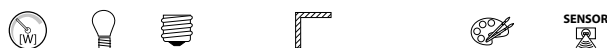

VADRA 16L-UP	<b>29010</b>	5905339290106	max 11	GLS\CFL\LED	E27	Wandmontage   wall mounted	anthrazit   anthracite	
VADRA 21L-UP SE	<b>29011</b>	5905339290113	max 11	GLS\CFL\LED	E27	Wandmontage   wall mounted	anthrazit   anthracite	PIR
VADRA 50	<b>29012</b>	5905339290120	max 11	GLS\CFL\LED	E27	Bodenmontage   surface mounted	anthrazit   anthracite	
VADRA 80	<b>29013</b>	5905339290137	max 11	GLS\CFL\LED	E27	Bodenmontage   surface mounted	anthrazit   anthracite	

[V] 220-240 AC	[Hz] 50			<b>IP 44</b>			
 1,5+2,5		 0,2m	<b>CE</b>	<b>EMC</b>	<b>UK</b>		

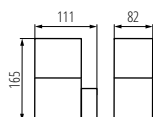

VADRA 16L

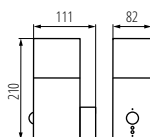

VADRA 21L

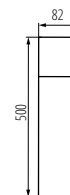

VADRA 50

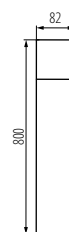

VADRA 80

# INVO OP

ARCHITEKTONISCHE LEUCHTE FÜR AUSTAUSCHBARE LEUCHTMITTEL  
 ► ARCHITECTURAL LIGHTING WITH REPLACEABLE SOURCE OF LIGHT



INVO OP 77-L-GR



INVO OP EL-53-L-GR



INVO OP 47-L-GR



INVO OP 77-L-GR



Kanlux INVO OP ist eine Serie von architektonischen Außenleuchten. Die ganze Serie besteht aus Poller- und einer Fassadenleuchten. Die Kanlux INVO-Leuchte ist eine Leuchte für austauschbare Leuchtmittel mit E27-Sockel, was die freie Wahl der Farbe und Intensität der Beleuchtung ermöglicht.

Milchiger Lampenschirm

Gehäusematerial: Kunststoff  
 Abdeckungsmaterial: Kunststoff

Kanlux INVO OP is a series of external architectural luminaires. The whole family is composed of posts and façade luminaires. You can use your favourite light colour in Kanlux INVO luminaires since it is adapted for replaceable sources with a E27 cap.

Milky lampshade

Enclosure material: plastic  
 Lampshade material: plastic



INVO OP EL-53-L-GR	<b>29170</b>	5905339291707	max 20	GLS\CFL\LED	E27	Wandmontage   wall mounted	graphit   graphite
INVO OP 47-L-GR	<b>29171</b>	5905339291714	max 20	GLS\CFL\LED	E27	Bodenmontage   surface mounted	graphit   graphite
INVO OP 77-L-GR	<b>29172</b>	5905339291721	max 20	GLS\CFL\LED	E27	Bodenmontage   surface mounted	graphit   graphite
INVO OP 107-L-GR	<b>29173</b>	5905339291738	max 20	GLS\CFL\LED	E27	Bodenmontage   surface mounted	graphit   graphite

<b>[V]</b> 220-240 AC	<b>[Hz]</b> 50				<b>IP</b> 54		

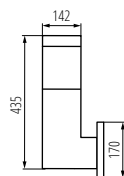

INVO OP EL-53

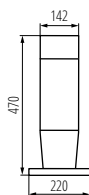

INVO OP 47

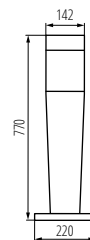

INVO OP 77

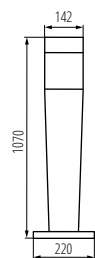

INVO OP 107

# INVO TR

ARCHITEKTONISCHE LEUCHE FÜR AUSTAUSCHBARE LEUCHTMITTEL  
 ► ARCHITECTURAL LIGHTING WITH REPLACEABLE SOURCE OF LIGHT



INVO TR 77-O-GR



INVO TR EL-53-O-GR



INVO TR 47-O-GR



INVO TR 107-O-GR



Kanlux INVO TR ist eine Serie von Architekturleuchten für austauschbare GU10-Leuchtmittel. Die Pollerleuchten und die Fassadenleuchte verteilen das Licht sehr effektiv nicht nur im Garten, sondern sie erleuchten auch Gassen, Pfade oder Spazierwege. Jede Leuchte bietet Platz für 3 Leuchtmittel.

Transparenter Diffusor

Gehäusematerial: Kunststoff  
 Abdeckungsmaterial: Kunststoff

Kanlux INVO TR is a series of architectural luminaires with a replaceable GU10 light source. External posts and is a series of external architectural luminaires offer a very effective distribution of light in the garden and lighting of alleys, paths or walking routes. Each luminaire has a space for 3 light sources.

Transparent lampshade

Enclosure material: plastic  
 Lampshade material: plastic



Model	Article No.	Dimensions	Base	Socket	Mounting	Material
INVO TREL-53-O-GR	29174	3 x max 3,5	PAR16	GU10	Wandmontage   wall mounted	graphit   graphite
INVO TR 47-O-GR	29175	3 x max 3,5	PAR16	GU10	Bodenmontage   surface mounted	graphit   graphite
INVO TR 77-O-GR	29176	3 x max 3,5	PAR16	GU10	Bodenmontage   surface mounted	graphit   graphite
INVO TR 107-O-GR	29177	3 x max 3,5	PAR16	GU10	Bodenmontage   surface mounted	graphit   graphite

[V] 220-240 AC	[Hz] 50				IP 54		 -20+35
	 0,75+2,5	 0,5m	CE	ERL	UK CA		

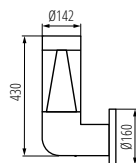

INVO TREL-53

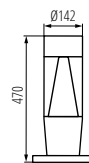

INVO TR 47

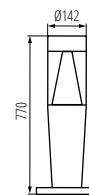

INVO TR 77

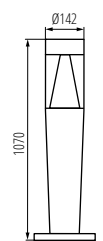

INVO TR 107



# STONO N

AUSSENLEUCHE FÜR AUSTAUSCHBARE LEUCHTMITTEL  
 ► GARDEN LIGHT FITTING WITH REPLACEABLE LIGHT SOURCE



STONO 20 N



STONO 230N

STONO 30

STONO 390 N

STONO 490N



STONO 585N

STONO 780N



Durchmesser [mm]

Model	Code	Part No.	Max. Length	Diameter	Light Source	Socket	Material	Finish
STONO 20 N	24654	5905339246547	max 15	200	GLS\CFL\LED	E27	Granit	Granite
STONO 30	24651	5905339246516	max 25	300	GLS\CFL\LED	E27	Granit	Granite
STONO 390 N	36591	5905339365910	max 20	390	GLS\CFL\LED	E27	Granit	Granite
STONO 490 N	36592	5905339365927	max 20	490	GLS\CFL\LED	E27	Granit	Granite
STONO 585 N	36593	5905339365934	max 20	585	GLS\CFL\LED	E27	Granit	Granite
STONO 780 N	36594	5905339365941	max 20	780	GLS\CFL\LED	E27	Granit	Granite
STONO 230 N	36595	5905339365958	max 20	230	GLS\CFL\LED	E27	Granit	Granite

<b>[V]</b> 220-240 AC	<b>[Hz]</b> 50			<b>IP</b> 65			
3	1	0,2m					



Die STONO N-Leuchten von Kanlux sind ein unbestrittener Gartenhit. Die steinimitierende Lichtkugeln mit einem Durchmesser von 20 bis 78 cm. Sie passen perfekt in Steingärten oder in die Umgebung von Sträuchern. Jede Leuchte ist mit Erdspeiben ausgestattet, mit denen sie in den Boden eingelassen werden kann, sowie mit einem langen Stromkabel (3 m). Kanlux STONO N sind Leuchten für austauschbare Lichtquellen.

3m-Kabel im Lieferumfang enthalten  
 Inklusive 4 Stück Erdspeibe für die Bodenmontage  
 Gehäusematerial: ABS  
 Abdeckungsmaterial: LLDPE

Kanlux STONO N fixtures are an undisputed garden hit. These are balls with diameters from 31 to 78 cm, imitating stones. They fit perfectly into rockeries or in the surroundings of shrubs. Each of them is equipped with spikes that allow the luminaire to be embedded in the ground and a long power cable (3 meters). Kanlux STONO N are luminaires for replaceable light sources.

a cable of 3m in a set  
 a set of 4 ground-mounted spikes included.

Enclosure material: ABS  
 Lampshade material: LLDPE

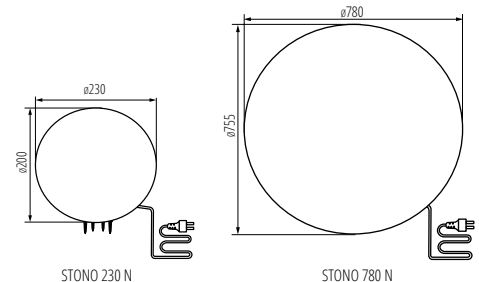

STONO 230 N

STONO 780 N

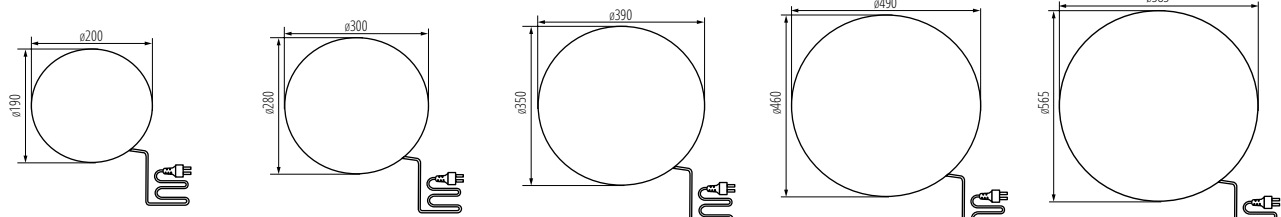

STONO 20 N

STONO 30

STONO 390 N

STONO 490 N

STONO 585 N



**Kanlux**

# USTI SP

AUSSENLEUCHE FÜR AUSTAUSCHBARE LEUCHTMITTEL

► GARDEN LIGHT FITTING WITH REPLACEABLE LIGHT SOURCE

**NEW**



USTI SP 2x7 GR



USTI SP 1x7 GR



USTI SP 2x7 GR	<b>36560</b>	5905339365606	2 x max 7	PAR16 LED	GU10	anthrazit   anthracite
USTI SP 1x7 GR	<b>36561</b>	5905339365613	max 7	PAR16 LED	GU10	anthrazit   anthracite

<b>[V]</b> 220-240 AC	<b>[Hz]</b> 50			<b>IP</b> 54		 -20+35	
	 0,5-1	 6-7,5	 0,5m	<b>CE</b>	<b>EMC</b>	<b>RoHS</b>	

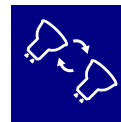

Kanlux USTI-Leuchten sind ideal für die gerichtete Beleuchtung von Grünflächen, Steingärten, Fassaden oder interessanten architektonischen Elementen, die wir hervorheben möchten. Die Konstruktion mit einem beweglichen Kopf ermöglicht es Ihnen, das Licht frei einzustellen und in die gewünschte Richtung zu lenken. Es gibt zwei Optionen - Leuchten mit einem oder zwei Lichtpunkten (die Lichtelemente können unabhängig voneinander eingestellt werden). Die Kanlux USTI-Gartenleuchten sind für Leuchtmittel mit GU10-Sockel geeignet.

Gehäusematerial: Aluminiumlegierung  
Abdeckungsmaterial: Glas

Kanlux USTI luminaires are ideal for directional illumination of greenery, rockeries, facades or interesting architectural elements that we want to emphasise. The design with a movable head allows you to freely adjust and direct the light in the desired way. There are two options - luminaires with one or two light points (the luminous elements can be adjusted independently of each other). Kanlux USTI garden luminaires are adapted to light sources with a GU10 base.

Enclosure material: aluminum alloy  
Lampshade material: glass

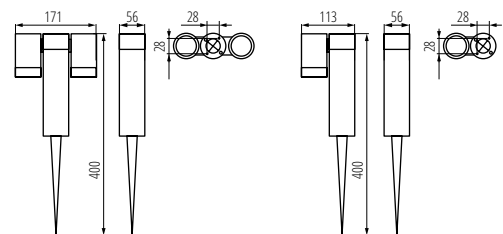

USTI SP 2x7 GR

USTI SP 1x7 GR

# Kanlux VORA

AUSSENLEUCHTE FÜR AUSTAUSCHBARE LEUCHTMITTEL  
▶ GARDEN LIGHT FITTING WITH REPLACEABLE LIGHT SOURCE



NEW



VORA SP 20 GR

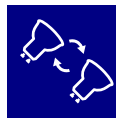

Kanlux VORA ist eine Außenleuchte mit austauschbarer Lichtquelle (Sockel GU10). Ihre Tragbarkeit (Befestigung im Boden mit einem Erdspieß) ermöglicht die Änderung der Beleuchtungsanordnung. Solide und ästhetisch ansprechende Verarbeitung, exklusives Aussehen, modernes Design und ein Kopf mit Flansch, der die Lichtstreuung begrenzt, sind nur einige ihrer Vorteile.

Gehäusematerial: Aluminiumlegierung  
Material der Schutzscheibe: PC

Kanlux VORA is an outdoor luminaire with a replaceable light source (GU10 base). Its portable nature (mounted in the ground with a spike) enables changing the arrangement of light illumination. Solid and aesthetically pleasing workmanship, exclusive appearance, modern design and a head with a flange that limits light scattering are just some of its advantages.

Enclosure material: aluminum alloy  
Protective glass material: PC



VORA SP 20 GR	<b>36565</b>	5905339365651	max 7	PAR16 LED	GU10	graphit   graphite
VORA EL 20 GR	<b>36566</b>	5905339365668	max 7	PAR16 LED	GU10	graphit   graphite

[V] 220-240 AC	[Hz] 50				IP 44		 -20+35
 90		CE	EAC	UK CA			

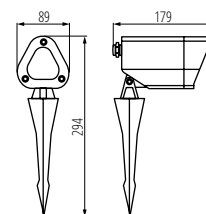

VORA SP 20 GR

Kanlux

# GRIBLO 7 GR

AUSSENLEUCHE FÜR AUSTAUSCHBARE LEUCHTMITTEL  
 ► GARDEN LIGHT FITTING WITH REPLACEABLE LIGHT SOURCE

NEW



GRIBLO 7 GR



GRIBLO 7 GR | 36432 | 5905339364326 max 7 PAR16 LED GU10 anthrazit | anthracite

[V] 220-240 AC	[Hz] 50			IP 65		 -20+35		 180
	 1	 0,5m	CE	ERL	UK CA			



Die Neuauflage von Kanlux GRIBLO ist das Modell 7 GR, das zur Beleuchtung von kleinen Bäumen, Sträuchern, Steingärten oder kleiner Architektur im Garten verwendet werden kann. Kanlux GRIBLO 7 GR ist als eine der wenigen Leuchten auf dem Markt mit einem Stromkabel mit Stecker ausgestattet, was nicht nur bequem für den Benutzer ist, sondern auch der neuesten Norm für tragbare Gartenleuchten entspricht. Die Befestigung der Leuchte im Boden erfolgt ganz einfach mit einem „Pick“, der in den Boden getrieben wird. Eine austauschbare Lichtquelle und die Wasserdichtigkeit gemäß IP65 sind weitere Vorteile der Leuchte.

Gehäusematerial: Aluminiumlegierung  
 Abdeckungsmaterial: Glas

The new Kanlux GRIBLO is model 7 GR, intended as backlighting for small trees, shrubs, rockeries or small architecture in the garden. Kanlux GRIBLO 7 GR is one of the few light fittings on the market equipped with a power cable terminated with a plug, which is not only convenient for the user but also complies with the latest standard for portable garden light fittings. Fixing it to the ground is very easy with a 'spike' hammered into the ground. A replaceable light source and IP65 water resistance are its additional strengths.

Enclosure material: aluminum alloy  
 Lampshade material: glass

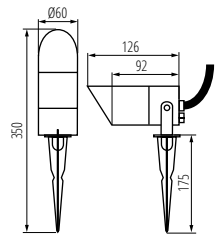

GRIBLO 7 GR

Kanlux

# AKVEN LED

AUSSENLEUCHE FÜR AUSTAUSCHBARE LEUCHTMITTEL ► GARDEN LIGHT FITTING WITH REPLACEABLE LIGHT SOURCE



AKVEN LED



AKVEN LED | 25720 | 5905339257208 max 35 MR16 Gx5,3 grün | green

[V] 12 AC; 12 DC	[Hz] 50			 300	 120	 ≥15000	 25000	 Tc (K) 3000	 ≤6°/MacAdam	 Ra 80		
IP 68		 -20+35		 180	 1-1,5	 0,5m	CE	ERL	UK CA			



Die wasserdichte Kanlux AKVEN LED-Leuchte ist die ideale Lösung für die Beleuchtung von Teichen. Sie ist mit einer austauschbaren LED-Lichtquelle ausgestattet und für das langfristige Eintauchen im Wasser bis zu einer Tiefe von 3 Metern ausgelegt.

Gehäusematerial: Aluminiumlegierung

Waterproof Kanlux AKVEN LED luminaire is a perfect solution for lighting ponds. It is equipped with a replaceable LED light source and adapted to long-term immersion in water, even 3 metres deep.

Enclosure material: aluminum alloy

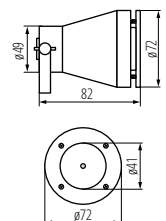

AKVEN LED



GRL 6M5E27-B



GRL 6M5E27-B



GRL 11M10E27-B



GRL 15M15E27-B



GRL 6M5E27-B	<b>35750</b>	5905339357502	5 x max 10	LED	E27	schwarz   black
GRL 11M10E27-B	<b>35754</b>	5905339357540	10 x max 10	LED	E27	schwarz   black
GRL 15M15E27-B	<b>35758</b>	5905339357588	15 x max 10	LED	E27	schwarz   black

<b>[V]</b> 220-240 AC	<b>[Hz]</b> 50				
 -20+40	 1,5				

ZUBEHÖR ► ACCESSORIES

ST45 LED 0,5W E27-NW	<b>26046</b>	5905339260468	Passendes Leuchtmittel für die Kanlux GRL-Lichterkette / A light source dedicated to Kanlux GRL string lights, (26046)
ST45 LED 0,5W E27-WW	<b>26045</b>	5905339260451	Passendes Leuchtmittel für die Kanlux GRL-Lichterkette / A light source dedicated to Kanlux GRL string lights, (26045)
ST45 LED 0,9W E27-BL	<b>26039</b>	5905339260390	Passendes Leuchtmittel für die Kanlux GRL-Lichterkette / A light source dedicated to Kanlux GRL string lights, (26039)
ST45 LED 0,9W E27-GR	<b>26048</b>	5905339260482	Passendes Leuchtmittel für die Kanlux GRL-Lichterkette / A light source dedicated to Kanlux GRL string lights, (26048)
ST45 LED 0,9W E27-RE	<b>26049</b>	5905339260499	Passendes Leuchtmittel für die Kanlux GRL-Lichterkette / A light source dedicated to Kanlux GRL string lights, (26049)



Die Kanlux GRL-Lichtgirlande ist eine Möglichkeit, die Beleuchtung innerhalb und außerhalb des Hauses schnell zu gestalten. Sie haben die Wahl zwischen drei Girlandenlängen: 5, 11 und 15 Meter. Dank der Durchgangsstromversorgung können Sie mehrere Girlanden miteinander verbinden und eine Installation von bis zu 150 Metern Länge schaffen. Für die Girlande empfehlen wir Kanlux ST45 LED-Lichtquellen mit 0,5W. Die GRL-Girlanden von Kanlux zeichnen sich durch ihr hochwertiges, sicheres 1,5mm<sup>2</sup>-Kabel aus.

Anschlussart: Kabel abgeschlossen mit einem Stecker

Kabel-Typ: H07RN-F

The Kanlux GRL string lights is a way to quickly arrange lighting inside and outside the house. There are three lengths of string lights to choose from: 5, 11 and 15 meters. Thanks to the feed-through power supply, you can connect several string lights together and create an installation up to 150 meters long. For string lights, we recommend Kanlux ST45 LED 0.5W light sources. Kanlux GRL string lights are distinguished by high-quality, safe 1.5mm<sup>2</sup> cable.

Connection type: Cable terminated with a plug

Wire type: H07RN-F

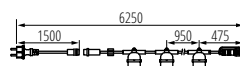

GRL 6M5E27-B

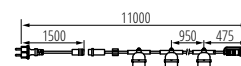

GRL 11M10E27-B

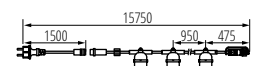

GRL 15M15E27-B

# Kanlux DASTO

STECKDOSENSÄULE 230-V ► GARDEN POST WITH 230V SOCKETS

NEW



DASTO 2SOC FR B

NICHT VERFÜGBAR FÜR DEN DEUTSCHEN MARKT

IP

DASTO 2SOC FR B | 36585 | 5905339365859 | 44 | anthrazit | anthracite

[V] 220-240 AC	In[A] 16		 1,5			
 -20+35	CE	EAC	UK CA			



Kanlux DASTO / NASTO Anschlusspfosten mit französischer Steckdosen. Dank ihrer schlichten Ästhetik, lassen sie sich in jede Art von Garten integrieren. Sie können einen Rasensprenger, einen Rasenmäher, einen Elektrogrill anschließen, eine Lichtergirlande, eine Winterbeleuchtung für einen Weihnachtsbaum im Freien oder jede andere tragbare Beleuchtung, die Sie benötigen

Material: Edelstahl

Kanlux DASTO / NASTO connection posts with French-type socket outlets. Thanks to their simple aesthetics, they can be integrated into any type of garden. You can connect to them a sprinkler, lawnmower, electric grill, light garland, winter lights for an outdoor Christmas tree or any other portable lighting you need.

Material: stainless steel

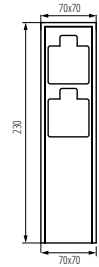

DASTO 2SOC FR B

# Kanlux NASTO

STECKDOSENSÄULE 230-V ► GARDEN POST WITH 230V SOCKETS

NEW



NASTO 2SOC FR B

NICHT VERFÜGBAR FÜR DEN DEUTSCHEN MARKT

IP

NASTO 2SOC FR B | 36586 | 5905339365866 | 44 | anthrazit | anthracite

[V] 220-240 AC	In[A] 16		 1,5			
 -20+35	CE	EAC	UK CA			



Kanlux DASTO / NASTO Anschlusspfosten mit französischer Steckdosen. Dank ihrer schlichten Ästhetik, lassen sie sich in jede Art von Garten integrieren. Sie können einen Rasensprenger, einen Rasenmäher, einen Elektrogrill anschließen, eine Lichtergirlande, eine Winterbeleuchtung für einen Weihnachtsbaum im Freien oder jede andere tragbare Beleuchtung, die Sie benötigen.

Material: Edelstahl

Kanlux DASTO / NASTO connection posts with French-type socket outlets. Thanks to their simple aesthetics, they can be integrated into any type of garden. You can connect to them a sprinkler, lawnmower, electric grill, light garland, winter lights for an outdoor Christmas tree or any other portable lighting you need.

Material: stainless steel

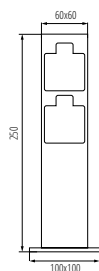

NASTO 2SOC FR B





# ACORD ATL1

LED-STRAHLER/ 3 PHASEN STROMSCHIENE ▶ TRACK LIGHT PROJECTOR



ATL1 30W



ATL1 18W



Kanlux ACORD ATL1 ist ein LED-Strahler für die Dreiphasen-Stromschiene, eine Leuchte, die man an die individuellen Bedürfnisse anpassen kann. Zwei Farbversionen: Weiß oder Schwarz, zwei Leistungen (18W und 30W), zwei Lichtfarben und drei Ausstrahlwinkel (Standard 60° - es ist aber möglich den Reflektor gegen einen mit 15° oder 36° zu tauschen). Kanlux ACORD ATL1 hat eine Lebensdauer von 50.000 Stunden und eine Garantie von 5 Jahren. Markenkomponenten (LED COB und Netzteil), hohe Farbwiedergabestufe (CRI>90) und Blendbegrenzung (UGR <19) sind weitere Vorteile dieser Leuchte.

5 Jahre Garantie gemäß den Bedingungen der Garantieerklärung, die auf der Website verfügbar ist

zur Montage auf der TEAR N-Sammelschiene

Gehäusematerial: Aluminiumlegierung

Material der Schutzscheibe: Kunststoff

Kanlux ACORD ATL1 are integrated lighting fixtures to be mounted on three-phase track. These are lamps that can be adapted to our individual needs. We can choose white or black, two powers (18W and 30W), light color and lighting angle (standard is 60°, but we can replace the reflector and change the angle to 15° or 36°) depending on whether we want to illuminate the surface or a specific detail. Kanlux ACORD ATL1 stands for 50 000 hours of durability and a 5-year warranty. Branded key components (LED COB and power supply), high level of real color rendering (CRI> 90) and elimination of glare (UGR <19) are other advantages of these unique luminaires.

5 years Warranty under the terms of the warranty statement, available on our website

for installation on the TEAR N busbar

Enclosure material: aluminum alloy

Protective glass material: plastic

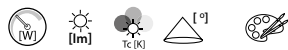

ATL1 18W-930-S6-W	<b>33130</b>	5905339331304	18	1700	3000	60	weiß   white
ATL1 18W-930-S6-B	<b>33131</b>	5905339331311	18	1700	3000	60	schwarz   black
ATL1 18W-940-S6-W	<b>33132</b>	5905339331328	18	1800	4000	60	weiß   white
ATL1 18W-940-S6-B	<b>33133</b>	5905339331335	18	1800	4000	60	schwarz   black
ATL1 30W-930-S6-W	<b>33134</b>	5905339331342	30	2850	3000	60	weiß   white
ATL1 30W-930-S6-B	<b>33135</b>	5905339331359	30	2850	3000	60	schwarz   black
ATL1 30W-940-S6-W	<b>33136</b>	5905339331366	30	3000	4000	60	weiß   white
ATL1 30W-940-S6-B	<b>33137</b>	5905339331373	30	3000	4000	60	schwarz   black

[V] 220-240 AC	[Hz] 50	 ≥30000	 50000	 elliptisch ≤ für Meckdam	 90	 COB			 IP 20	
 5+25		 315	 90	 0,5m						

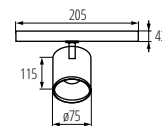

ATL1 18W-930-S6

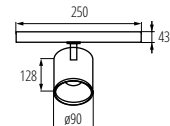

ATL1 30W-930-S6

# ACORD ATL1

LED-STRAHLER/ 3 PHASEN STROMSCHIENE ► TRACK LIGHT PROJECTOR



ATL1 18W



ATL1 18W



ATL1 30W



ATL1 30W

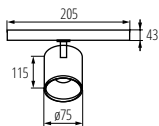

ATL1 18W-930-56

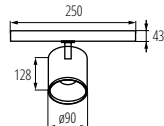

ATL1 30W-930-56

## ZUBEHÖR ► ACCESSORIES

REF ATL1-18W-S15	<b>33140</b>	5905339331403	Reflektor zu ATL 1, 18W, 15 Grad   Reflector for the ATL 1 luminaire, 18 W, 15 degrees
REF ATL1-18W-S36	<b>33141</b>	5905339331410	Reflektor zu ATL 1, 18W, 36 Grad   Reflector for the ATL 1 luminaire, 18 W, 36 degrees
REF ATL1-30W-S15	<b>33142</b>	5905339331427	Reflektor zu ATL 1, 30W, 15 Grad   Reflector for the ATL 1 luminaire, 30 W, 15 degrees
REF ATL1-30W-S36	<b>33143</b>	5905339331434	Reflektor zu ATL 1, 30W, 36 Grad   Reflector for the ATL 1 luminaire, 30 W, 36 degrees



Kanlux

# ACORD ATL2 GU10

LED-STRAHLER/ 3 PHASEN STROMSCHIENE ▶ TRACK LIGHT PROJECTOR



ATL2 GU10-W



ATL2 GU10-W	<b>33138</b>	5905339331380	weiß   white	GU10
ATL2 GU10-B	<b>33139</b>	5905339331397	schwarz   black	GU10

[V] 220-240 AC	[Hz] 50	[W] max 10	PAR16	IP 20	5+25	UK CA
330	100	0,5m	CE	ERL	PZH	UK CA



PRODUKT Z ATESTEM



Kanlux ACORD ATL 2 ist ein LED-Strahler für die Dreiphasen-Stromschiene, geeignet für austauschbare MR16-LED-Leuchtmittel mit Sockel GU10. Zwei Farben stehen zur Auswahl: weiß und schwarz. Je nach den individuellen Bedürfnissen kann man die richtige Lichtfarbe, den Ausstrahlwinkel und die Leistung aus einem breitem Spektrum an Leuchtmitteln auswählen. Die Leuchten Kanlux ACORD ATL 2 haben 5 Jahre Garantie.

zur Montage auf der TEAR N-Sammelschiene  
Gehäusematerial: Aluminiumlegierung

Kanlux ACORD ATL 2 are lighting fixtures to be mounted on three-phase track. These are lamps with a replaceable light source that can be adapted to our individual needs. We can choose the color of the fitting: white or black, and a light source. Depending on our needs, we can choose the right color, lighting angle and power. Kanlux ACORD ATL 1 luminaires have a 5-year warranty.

for installation on the TEAR N busbar  
Enclosure material: aluminum alloy

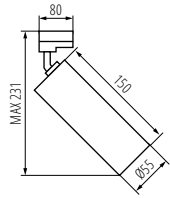

ATL2 GU10

Kanlux

# ACORD ATL3 GU10

LED-STRAHLER/ 3 PHASEN STROMSCHIENE ▶ TRACK LIGHT PROJECTOR



ATL3 GU10-B

NEW



ATL3 GU10-B	<b>33144</b>	5905339331441	schwarz   black	GU10
ATL3 GU10-W	<b>33145</b>	5905339331458	weiß   white	GU10

[V] 220-240 AC	[Hz] 50	[W] max 10	PAR16	IP 20	5+25	UK CA
330	90	0,5m	CE	ERL	PZH	UK CA



PRODUKT Z ATESTEM



Kanlux ATL3 sind Strahler für den Einbau in 3-Phasen-Schienen. Sie sind aus einer Aluminiumlegierung gefertigt und zeichnen sich durch eine austauschbare Lichtquelle mit einem GU10-Sockel. Kanlux ATL3-Leuchten haben zwei Drehachsen - horizontal 330 und vertikal 90 Grad. Sie können zwischen zwei Farben wählen: weiß oder schwarz. Sie erhalten eine 5 Jahre Garantie für Kanlux ACORD ATL-Lampen.

5 Jahre Garantie gemäß den Bedingungen der Garantieerklärung, die auf der Website verfügbar ist

zur Montage auf der TEAR N-Sammelschiene  
Gehäusematerial: Aluminiumlegierung

Kanlux ATL3 are lighting fixtures for installation on 3-circuit tracks. They are made of aluminum alloy and are characterized by a replaceable light source with a GU10 base. Kanlux ATL3 fixtures have two rotation axes - horizontal 330 and vertical 90 degrees, you can also choose white or black color of the fixture. You receive a 5-year warranty for Kanlux ACORD ATL lamps.

5 years Warranty under the terms of the warranty statement, available on our website  
Enclosure material: aluminum alloy

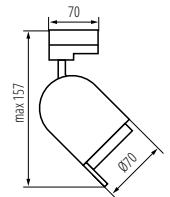

ATL3 GU10

Kanlux

# ACORD ATL4 GU10

LED-STRAHLER/ 3 PHASEN STROMSCHIENE ▶ TRACK LIGHT PROJECTOR



NEW

ATL4 GU10-B

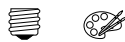

ATL4 GU10-B	<b>33146</b>	5905339331465	GU10	schwarz   black
ATL4 GU10-W	<b>33147</b>	5905339331472	GU10	weiß   white

[V] 220-240 AC	[Hz] 50	[W] max 10	[PAR] PAR16	[IP] IP 20	[H] max 10	[E]
[C] 5+25	[L]	[A]330	[D]90	[R] 0,5m	[S]	[CE]
ERC	UK	[E]				

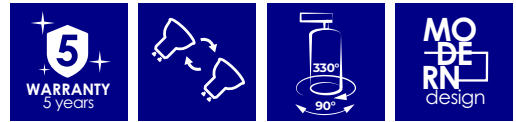

Kanlux ATL4 sind Strahler für den Einbau in 3-Phasen-Schienen. Sie sind aus einer Aluminiumlegierung gefertigt und zeichnen sich durch eine austauschbare Lichtquelle mit einem GU10-Sockel. Kanlux ATL4-Leuchten haben zwei Drehachsen - horizontal 330 und vertikal 90 Grad. Sie können zwischen zwei Farben wählen: weiß oder schwarz. Sie erhalten eine 5 Jahre Garantie für Kanlux ACORD ATL-Lampen.

5 Jahre Garantie gemäß den Bedingungen der Garantieerklärung, die auf der Website verfügbar ist  
zur Montage auf der TEAR N-Sammelschiene  
Gehäusematerial: Aluminiumlegierung

Kanlux ATL4 are lighting fixtures for installation on 3-circuit tracks. They are made of aluminum alloy and are characterized by a replaceable light source with a GU10 base. Kanlux ATL4 fixtures have two rotation axes - horizontal 330 and vertical 90 degrees, you can also choose white or black color of the fixture. You receive a 5-year warranty for Kanlux ACORD ATL lamps.

5 years Warranty under the terms of the warranty statement, available on our website  
Enclosure material: aluminum alloy

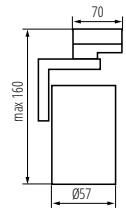

ATL4 GU10

Kanlux

# ACORD ATL5 GU10

LED-STRAHLER/ 3 PHASEN STROMSCHIENE ▶ TRACK LIGHT PROJECTOR



NEW

ATL5 GU10-W

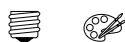

ATL5 GU10-B	<b>33148</b>	5905339331489	GU10	schwarz   black
ATL5 GU10-W	<b>33149</b>	5905339331496	GU10	weiß   white

[V] 220-240 AC	[Hz] 50	[W] max 10	[PAR] PAR16	[IP] IP 20	[H] max 10	[E]
[C] 5+25	[L]	[A] 330	[D] 120	[R] 0,5m	[S]	[CE]
ERC	UK	[E]				

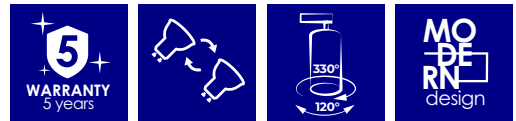

Kanlux ATL5 sind Strahler für den Einbau in 3-Phasen-Schienen. Sie sind aus einer Aluminiumlegierung gefertigt und zeichnen sich durch eine austauschbare Lichtquelle mit einem GU10-Sockel. Kanlux ATL5-Leuchten haben zwei Drehachsen - horizontal 330 und vertikal 120 Grad. Sie können zwischen zwei Farben wählen: weiß oder schwarz. Sie erhalten eine 5 Jahre Garantie für Kanlux ACORD ATL-Lampen.

5 Jahre Garantie gemäß den Bedingungen der Garantieerklärung, die auf der Website verfügbar ist  
zur Montage auf der TEAR N-Sammelschiene  
Gehäusematerial: Aluminiumlegierung

Kanlux ATL5 are lighting fixtures for installation on 3-circuit tracks. They are made of aluminum alloy and are characterized by a replaceable light source with a GU10 base. Kanlux ATL5 fixtures have two rotation axes - horizontal 330 and vertical 120 degrees, you can also choose white or black color of the fixture. You receive a 5-year warranty for Kanlux ACORD ATL lamps.

5 years Warranty under the terms of the warranty statement, available on our website  
Enclosure material: aluminum alloy

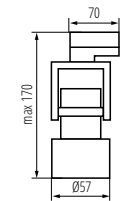

ATL5 GU10

# BTL LED

LED-STRAHLER/ 3 PHASEN STROMSCHIENE ▶ TRACK LIGHT PROJECTOR



BTL 18W-930-W



BTL 18W-930-B



BTL 18W-940-W



Kanlux BTL LED ist ein neues Leuchtendesign, das an das Kanlux TEAR-System und an die meisten 3-Phasen-Stromschienensysteme angepasst ist. Die Leuchten sind mit einem in den Adapter integrierten Netzteil ausgestattet. Kanlux BTL sind Richtstrahler mit Linse und einem einstellbaren Leuchtwinkel von 15° bis 45°. Bei Kanlux BTL können wir die Wattzahl (18W 28W 38W), die Farbe des Gehäuses (weiß oder schwarz) und die Lichtfarbe (warm oder neutral) wählen. Die Leuchtenserie Kanlux BTL hat einen hohen Farbwiedergabeindex Ra 90+, und ihre hohe Verarbeitungsqualität wird durch eine 5-jährige Garantie bestätigt.

5 Jahre Garantie gemäß den Bedingungen der Garantieerklärung, die auf der Website verfügbar ist

Gehäusematerial: Aluminiumlegierung

Kanlux BTL LED is a new design of luminaires adapted to the Kanlux TEAR system and to the majority of 3-circuit rail systems. Luminaires are equipped with a power supply integrated with the adapter. Kanlux BTL are luminaires in the directional version with a lens and lighting angle adjustment in the range from 15° to 45°. In Kanlux BTL we can choose the power (18W 28W 38W), the color of the housing (white or black) and the color of light (warm or neutral). The Kanlux BTL series of luminaires has a high color rendering index Ra 90+, and their high quality is confirmed by a 5-year warranty.

5 years Warranty under the terms of the warranty statement, available on our website  
Enclosure material: aluminum alloy

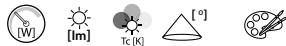

BTL 18W-930-W	<b>35650</b>	5905339356505	18	1800	3000	15-45	weiß   white
BTL 18W-930-B	<b>35651</b>	5905339356512	18	1750	3000	15-45	schwarz   black
BTL 18W-940-W	<b>35652</b>	5905339356529	18	1800	4000	15-45	weiß   white
BTL 18W-940-B	<b>35653</b>	5905339356536	18	1750	4000	15-45	schwarz   black
BTL 28W-930-W	<b>35654</b>	5905339356543	28	3000	3000	15-45	weiß   white
BTL 28W-930-B	<b>35655</b>	5905339356550	28	2800	3000	15-45	schwarz   black
BTL 28W-940-W	<b>35656</b>	5905339356567	28	3000	4000	15-45	weiß   white
BTL 28W-940-B	<b>35657</b>	5905339356574	28	2800	4000	15-45	schwarz   black
BTL 38W-930-W	<b>35658</b>	5905339356581	38	4000	3000	15-45	weiß   white
BTL 38W-930-B	<b>35659</b>	5905339356598	38	3800	3000	15-45	schwarz   black
BTL 38W-940-W	<b>35660</b>	5905339356604	38	4000	4000	15-45	weiß   white
BTL 38W-940-B	<b>35661</b>	5905339356611	38	3800	4000	15-45	schwarz   black

[V] 220-240 AC	[Hz] 50	⚡ ≥30000	⌚ 50000	☀️ Ra 90	🔧 COB
🌀 90	🏠 IP 20	🌡️ 5+25	🔌 340	🇬🇧 UK	🇪🇺 CE
📏 0,5m	🇪🇪 EAC	🇬🇧 UK	♻️		

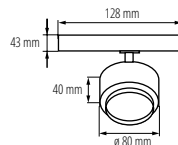

BTL 18W

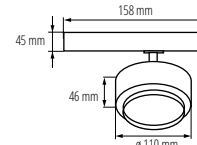

BTL 28W

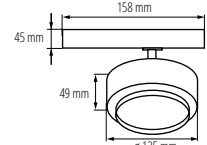

BTL 38W

# BTLW LED

LED-STRAHLER/ 3 PHASEN STROMSCHIENE ▶ TRACK LIGHT PROJECTOR



BTLW 18W-930-W



BTLW 18W-930-W



BTLW 18W-930-B



BTLW 18W-940-W

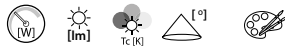

BTLW 18W-930-W	<b>35662</b>	5905339356628	18	1450	3000	120	weiß   white
BTLW 18W-930-B	<b>35663</b>	5905339356635	18	1400	3000	120	schwarz   black
BTLW 18W-940-W	<b>35664</b>	5905339356642	18	1450	4000	120	weiß   white
BTLW 18W-940-B	<b>35665</b>	5905339356659	18	1400	4000	120	schwarz   black

<b>[V]</b> 220-240 AC	<b>[Hz]</b> 50	<b>[h]</b> ≥30000	<b>[h]</b> 50000	<b>[lm]</b> ellipse ≤ 60 MacAdam	<b>Ra</b> 90	<b>[°]</b> COB
<b>[IP]</b> 20	<b>[°C]</b> 5+25	<b>[m]</b> 0,5m	<b>[°]</b> 90	<b>[°]</b> 340	<b>[°]</b> 90	<b>[°]</b> 340
<b>[CE]</b>	<b>[EAC]</b>	<b>[UK CA]</b>	<b>[UK CA]</b>	<b>[UK CA]</b>	<b>[UK CA]</b>	<b>[UK CA]</b>

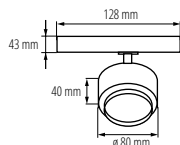

BTLW 18W-930-W

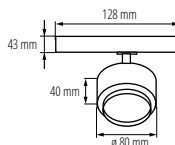

BTLW 18W-930-B

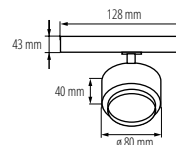

BTLW 18W-940-W

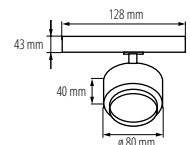

BTLW 18W-940-B



Kanlux BTLW LED ist ein neues Leuchtendesign, das an das Kanlux-TEAR-System und an die meisten 3-Phasen-Schiensysteme angepasst ist. Die Leuchten sind mit einem in den Adapter integrierten Netzteil ausgestattet. Kanlux BTLW zeichnen sich durch einen milchig-diffusen Diffusor aus, der einen breiten Ausleuchtungswinkel von 120° bietet. Sie sind in 18 W, zwei Gehäusefarben (weiß oder schwarz) und zwei Lichtfarben erhältlich. Sie eignen sich hervorragend für den Einsatz in Haushalten, als Allgemeinbeleuchtung und überall dort, wo ein breiter Leuchtwinkel erforderlich ist.

5 Jahre Garantie gemäß den Bedingungen der Garantieerklärung, die auf der Website verfügbar ist

Gehäusematerial: Aluminiumlegierung

Kanlux BTLW LED is a new design of luminaires adapted to the Kanlux TEAR rail system and to the majority of 3-circuit rail systems. Luminaires are equipped with a power supply integrated with the adapter. Kanlux BTLW are characterized by a milky lamp diffusing light, providing a wide viewing angle of 120°. They are available in 18W, two housing colors (white or black) and two light colors. They are perfect for home conditions, as general lighting and wherever a wide lighting beam angle of the luminaire is needed

5 years Warranty under the terms of the warranty statement, available on our website







Enclosure material: aluminum alloy

# TEAR N

ZUBEHÖR FÜR SCHIENENSYSTEM ► ACCESSORY FOR ELECTRICAL SUPPLY TRACK SYSTEMS

AUFPUTZVERSION / SURFACE VERSION

		TEAR N TR 1M-W	<b>33230</b>	590533932301	Zubehör für Schienensystem, TEAR N TR 1M-W, 3-Phasen-Stromschiene, weiß, (33230)   Track system component, TEAR N TR 1M-W, 3-circuit track, white, (33230)
		TEAR N TR 1M-B	<b>33231</b>	590533932318	Zubehör für Schienensystem, TEAR N TR 1M-B, 3-Phasen-Stromschiene, schwarz, (33231)   Track system component, TEAR N TR 1M-B, 3-circuit track, black, (33231)
		TEAR N TR 2M-W	<b>33232</b>	590533932325	Zubehör für Schienensystem, TEAR N TR 2M-W, 3-Phasen-Stromschiene, weiß, (33232)   Track system component, TEAR N TR 2M-W, 3-circuit track, white, (33232)
		TEAR N TR 2M-B	<b>33233</b>	590533932332	Zubehör für Schienensystem, TEAR N TR 2M-B, 3-Phasen-Stromschiene, schwarz, (33233)   Track system component, TEAR N TR 2M-B, 3-circuit track, black, (33233)
		TEAR N PCON R-W	<b>33234</b>	590533932349	Zubehör für Schienensystem, TEAR N PCON R-W, Stromeinspeisung mit R-Stecker, weiß, (33234)   Track system component, TEAR N PCON R-W, power connector with plug R, white, (33234)
		TEAR N PCON R-B	<b>33235</b>	590533932356	Zubehör für Schienensystem, TEAR N PCON R-B, Stromeinspeisung mit R-Stecker, weiß, (33235)   Track system component, TEAR N PCON R-B, power connector with plug R, black, (33235)
		TEAR N PCON L-W	<b>33260</b>	590533932608	Zubehör für Schienensystem, TEAR N PCON L-W, Stromeinspeisung mit L-Stecker, schwarz, (33260)   Track system component, TEAR N PCON L-W, power connector with plug L, white, (33260)
		TEAR N PCON L-B	<b>33261</b>	590533932615	Zubehör für Schienensystem, TEAR N PCON L-B, Stromeinspeisung mit L-Stecker, schwarz, (33261)   Track system component, TEAR N PCON L-B, power connector with plug L, black, (33261)
		TEAR N EPLUG W	<b>33236</b>	590533932363	Zubehör für Schienensystem, TEAR N EPLUG W, Verschlusskappe, weiß, (33236)   Track system component, TEAR N EPLUG W, end plug, white, (33236)
		TEAR N EPLUG B	<b>33237</b>	590533932370	Zubehör für Schienensystem, TEAR N EPLUG B, Verschlusskappe, Schwarz, (33237)   Track system component, TEAR N EPLUG B, end cap, black, (33237)
		TEAR N ICON-I W	<b>33238</b>	590533932387	Zubehör für Schienensystem, TEAR N ICON-I W, Innenverbinder Typ „I“ mit Steckern L und R, weiß, (33238)   Track system component, TEAR N ICON-I W, straight connector type „I“ internal with plugs L, R, white, (33238)
		TEAR N ICON-I B	<b>33239</b>	590533932394	Zubehör für Schienensystem, TEAR N ICON-I B, Innenverbinder Typ „I“ mit Steckern L und R, schwarz, (33239)   Track system component, TEAR N ICON-I B, straight connector type „I“ internal with plugs L, R, black, (33239)
		TEAR N CON-I W	<b>33240</b>	590533932400	Zubehör für Schienensystem, TEAR N CON-I W, gerades Verbindungsstück mit L- und R-Stecker, weiß, (33240)   Track system component, TEAR N CON-I W, straight connector type „I“ with plugs L, R, white, (33240)
		TEAR N CON-I B	<b>33241</b>	590533932417	Zubehör für Schienensystem, TEAR N CON-I B, gerades Verbindungsstück mit L- und R-Stecker, schwarz, (33241)   Track system component, TEAR N CON-I B, straight connector type „I“ with plugs L, R, black, (33241)
		TEAR N CON-I FLEX W	<b>33252</b>	590533932523	Zubehör für Schienensystem, TEAR N CON-I FLEX W, elastisches Verbindungsstück mit L- und R-Stecker, weiß, (33252)   Track system component, TEAR N CON-I FLEX W, flexible connector with plugs L, R, white, (33252)
		TEAR N CON-I FLEX B	<b>33253</b>	590533932530	Zubehör für Schienensystem, TEAR N CON-I FLEX B, elastisches Verbindungsstück mit L- und R-Stecker, schwarz, (33253)   Track system component, TEAR N CON-I FLEX B, flexible connector with plugs L, R, black, (33253)
		TEAR N CON-L RL-W	<b>33242</b>	590533932424	Zubehör für Schienensystem, TEAR N CON-L RL-W, Eckverbinder Typ „L“ mit R- und L-Stecker, weiß, (33242)   Track system component, TEAR N CON-L RL-W, corner connector type „L“ with plugs R, L, white, (33242)
		TEAR N CON-L RL-B	<b>33243</b>	590533932431	Zubehör für Schienensystem, TEAR N CON-L RL-B, Eckverbinder Typ „L“ mit R- und L-Stecker, schwarz, (33243)   Track system component, TEAR N CON-L RL-B, corner connector type „L“ with plugs R, L, black, (33243)
		TEAR N CON-L LR-W	<b>33244</b>	590533932448	Zubehör für Schienensystem, TEAR N CON-L LR-W, Eckverbinder Typ „L“ mit L- und R-Stecker, weiß, (33244)   Track system component, TEAR N CON-L LR-W, corner connector type „L“ with plugs L, R, white, (33244)
		TEAR N CON-L LR-B	<b>33245</b>	590533932455	Zubehör für Schienensystem, TEAR N CON-L LR-B, Eckverbinder Typ „L“ mit L- und R-Stecker, schwarz, (33245)   Track system component, TEAR N CON-L LR-B, corner connector type „L“ with plugs L, R, black, (33245)
		TEAR N CON-X W	<b>33246</b>	590533932462	Zubehör für Schienensystem, TEAR N CON-X W, Kreuzverbindungsstück mit den Steckern L, L, R und R, weiß, (33246)   Track system component, TEAR N CON-X W, cross connector with plugs L, L, R, R, white, (33246)
		TEAR N CON-X B	<b>33247</b>	590533932479	Zubehör für Schienensystem, TEAR N CON-X B, Kreuzverbindungsstück mit den Steckern L, L, R und R, schwarz, (33247)   Track system component, TEAR N CON-X B, cross connector with plugs L, L, R, R, black, (33247)

		TEAR N CON-T RRL-W	<b>33248</b>	5905339332486	Zubehör für Schienensystem, TEAR N CON-T RRL-W, Verbindungsstück Typ „T“ mit Steckern R, R und L, weiß, (33248)   Track system component, TEAR N CON-T RRL-W, connector type „T“ with plugs R, R, L, white, (33248)
		TEAR N CON-T RRL-B	<b>33249</b>	5905339332493	Zubehör für Schienensystem, TEAR N CON-T RRL-B, Verbindungsstück Typ „T“ mit Steckern R, R und L, schwarz, (33249)   Track system component, TEAR N CON-T RRL-B, connector type „T“ with plugs R, R, L, black, (33249)
		TEAR N CON-T RLL-W	<b>33250</b>	5905339332509	Zubehör für Schienensystem, TEAR N CON-T RLL-W, Verbindungsstück Typ „T“ mit Steckern R, L und L, weiß, (33250)   Track system component, TEAR N CON-T RLL-W, connector type „T“ with plugs R, L, L, white, (33250)
		TEAR N CON-T RLL-B	<b>33251</b>	5905339332516	Zubehör für Schienensystem, TEAR N CON-T RLL-B, Verbindungsstück Typ „T“ mit Steckern R, L und L, schwarz, (33251)   Track system component, TEAR N CON-T RLL-B, connector type „T“ with plugs R, L, L, black, (33251)
		TEAR N CON-T LRR-W	<b>33262</b>	5905339332622	Zubehör für Schienensystem, TEAR N CON-T LRR-W, Verbindungsstück Typ „T“ mit Steckern L, R und R, weiß, (33262)   Track system component, TEAR N CON-T LRR-W, connector type „T“ with plugs L, R, R, white, (33262)
		TEAR N CON-T LRR-B	<b>33263</b>	5905339332639	Zubehör für Schienensystem, TEAR N CON-T LRR-B, Verbindungsstück Typ „T“ mit Steckern L, R und R, schwarz, (33263)   Track system component, TEAR N CON-T LRR-B, connector type „T“ with plugs L, R, R, black, (33263)
		TEAR N CON-T LLR-W	<b>33264</b>	5905339332646	Zubehör für Schienensystem, TEAR N CON-T LLR-W, Verbindungsstück Typ „T“ mit Steckern L, L und R, weiß, (33264)   Track system component, TEAR N CON-T LLR-W, connector type „T“ with plugs L, L, R, white, (33264)
		TEAR N CON-T LLR-B	<b>33265</b>	5905339332653	Zubehör für Schienensystem, TEAR N CON-T LLR-B, Verbindungsstück Typ „T“ mit Steckern L, L und R, schwarz, (33265)   Track system component, TEAR N CON-T LLR-B, connector type „T“ with plugs L, L, R, black, (33265)
		TEAR N SKIT W	<b>33256</b>	5905339332561	Zubehör für Schienensystem, TEAR N SKIT W, Aufhängung mit automatischer Anpassung und 2 m Kabel, weiß, (33256)   Track system component, TEAR N SKIT W, suspension with self-regulation and cord 2m, white, (33256)
		TEAR N SKIT B	<b>33257</b>	5905339332578	Zubehör für Schienensystem, TEAR N SKIT B, Aufhängung mit automatischer Anpassung und 2 m Kabel, schwarz, (33257)   Track system component, TEAR N SKIT B, suspension with self-regulation and cord 2m, black, (33257)
		TEAR N SCLAMP W	<b>33254</b>	5905339332547	Zubehör für Schienensystem, TEAR N SCLAMP W, Montagehalterung/Fixierung, weiß, (33254)   Track system component, TEAR N SCLAMP W, mounting/stiffening suspension clamp, white, (33254)
		TEAR N SCLAMP B	<b>33255</b>	5905339332554	Zubehör für Schienensystem, TEAR N SCLAMP B, Montagehalterung/Fixierung, schwarz, (33255)   Track system component, TEAR N SCLAMP B, mounting/stiffening suspension clamp, black, (33255)
		TEAR N PADAPTOR-W	<b>33266</b>	5905339332660	Zubehör für Schienensystem, TEAR N PADAPTOR-W, Adapter mit Zugentlastung, weiß   Track system component, TEAR N PADAPTOR-W, adapter with cable relief, white, (33266)
		TEAR N PADAPTOR-B	<b>33267</b>	5905339332677	Zubehör für Schienensystem, TEAR N PADAPTOR-B, Adapter mit Zugentlastung, schwarz   Track system component, TEAR N PADAPTOR-B, adapter with cable relief, black, (33267)

**NEW** UNTERPUTZVERSION / RECESSED VERSION

	TEAR N R-TR 2M-W	<b>35800</b>	5905339358004	Schienensystemkomponente, TEAR N R-TR 2M-W, 3-Phasen-Einbauschiene, weiß, (35800)   Track system component, TEAR N R-TR 2M-W, 3-way flush-mounted busbar, white, (35800)
	TEAR N R-TR 2M-B	<b>35801</b>	5905339358011	Schienensystemkomponente, TEAR N R-TR 2M-W, 3-Phasen-Einbauschiene, schwarz, (35801)   Track system component, TEAR N R-TR 2M-W, 3-way flush-mounted busbar, black, (35801)
	TEAR N RC-PCON W	<b>35790</b>	5905339357908	Zubehör für Schienensystem, TEAR N RC-PCON W, Abdeckung für Stromschiene, weiß, (35790)   Track system component, TEAR N RC-PCON W, cover for current terminal, white, (35790)
	TEAR N RC-PCON B	<b>35791</b>	5905339357915	Zubehör für Schienensystem, TEAR N RC-PCON W, Abdeckung für Stromschiene, schwarz, (35791)   Track system component, TEAR N RC-PCON W, cover for current terminal, black, (35791)
	TEAR N RC-CON-I W	<b>35794</b>	5905339357946	Zubehör für Schienensystem, TEAR N RC-CON-I W, Abdeckung für geraden Steckverbinder Typ I, weiß, (35794)   Track system component, TEAR N RC-CON-I W, cover for I-type straight connector, white, (35794)
	TEAR N RC-CON-I B	<b>35795</b>	5905339357953	Zubehör für Schienensystem, TEAR N RC-CON-I W, Abdeckung für geraden Steckverbinder Typ I, schwarz, (35795)   Track system component, TEAR N RC-CON-I W, cover for I-type straight connector, black, (35795)
	TEAR N RC-CON-L W	<b>35792</b>	5905339357922	Zubehör für Schienensystem, TEAR N RC-CON-L W, Abdeckung für L-Eckverbinder, weiß, (35792)   Track system component, TEAR N RC-CON-L W, cover for L-type corner connector, white, (35792)



# TEAR N

ZUBEHÖR FÜR SCHIENENSYSTEM ▶ ACCESSORY FOR ELECTRICAL SUPPLY TRACK SYSTEMS

	TEAR N RC-CON-L-B	35793	5905339357939	Zubehör für Schienensystem, TEAR N RC-CON-L W, Abdeckung für L-Eckverbinder, schwarz, (35793)   Track system component, TEAR N RC-CON-L W, cover for L-type corner connector, black, (35793)
	TEAR N RC-CON-X-W	35798	5905339357984	Zubehör für Schienensystem, TEAR N RC-CON-X W, Abdeckung für X-Steckverbinder, weiß, (35798)   Track system component, TEAR N RC-CON-X W, cover for X-type connector, white, (35798)
	TEAR N RC-CON-X-B	35799	5905339357991	Zubehör für Schienensystem, TEAR N RC-CON-X W, Abdeckung für X-Steckverbinder, schwarz, (35799)   Track system component, TEAR N RC-CON-X W, cover for X-type connector, black, (35799)
	TEAR N RC-CON-T-W	35796	5905339357960	Zubehör für Schienensystem, TEAR N RC-CON-T W, Abdeckung für T-Steckverbinder, weiß, (35796)   Track system component, TEAR N RC-CON-T W, cover for T-type connector, white, (35796)
	TEAR N RC-CON-T-B	35797	5905339357977	Zubehör für Schienensystem, TEAR N RC-CON-T W, Abdeckung für T-Steckverbinder, schwarz, (35797)   Track system component, TEAR N RC-CON-T W, cover for T-type connector, black, (35797)
	TEAR N RCLIP-W	35802	5905339358028	Zubehör für Schienensystem, TEAR N RCLIP-W, Unterputzclip, weiß, (35802)   Track system component, TEAR N RCLIP-W, flush-mounted clip, white, (35802)
	TEAR N RCLIP-B	35803	5905339358035	Zubehör für Schienensystem, TEAR N RCLIP-W, Unterputzclip, schwarz, (35803)   Track system component, TEAR N RCLIP-W, flush-mounted clip, black, (35803)

## Kanlux TEAR N Anschlussdiagramme Connection diagrams

**TEAR N RC** Abdeckung für Unterputzmontage TEAR N R-TR cover for flush-mounting TEAR N R-TR

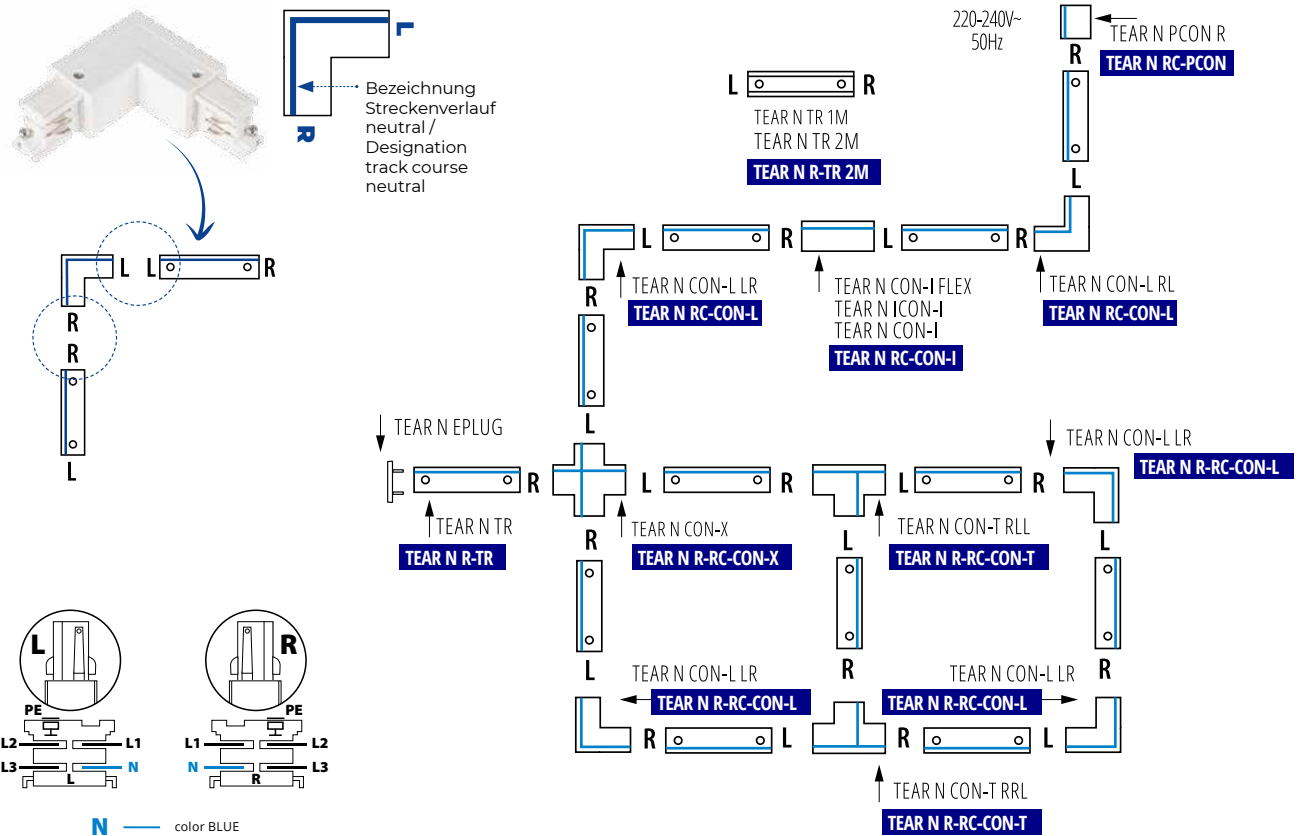

# TEAR N PADAPTOR

ZUBEHÖR FÜR SCHIENENSYSTEM  
 ► ACCESSORY FOR ELECTRICAL SUPPLY TRACK SYSTEMS



TEAR N PADAPTOR-W



TEAR N PADAPTOR-B



TEAR N PADAPTOR-W	<b>33266</b>	5905339332660	weiß   white
TEAR N PADAPTOR-B	<b>33267</b>	5905339332677	schwarz   black

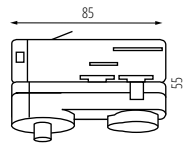

max ø6mm

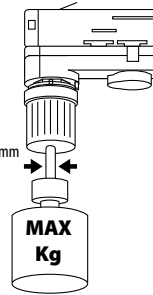

	max kg
2 x 0,75	2,2
2 x 1,00	2,9
3 x 0,75	3,3
3 x 1,00	4,4

<b>[V]</b> 220-240 AC	<b>[Hz]</b> 50	<b>In[A]</b> 10		<b>IP</b> 20		 5+25



# ***Kanlux***



## **KANLUX SMART ACCESSOIRES** KANLUX SMART EQUIPMENT

**Die SMART-Geräte von Kanlux sind so einfach zu konfigurieren, dass es jeder tun kann. Sie können sie mit anderen Geräten verwenden, die Sie bereits nutzen - Lampen, Heizungen, Steckdosen - sowie neue Geräte wie Sensoren. So können Sie sofort mit der Steuerung Ihres Hauses beginnen - ohne Renovierungen, Umbauten und Hämmern an den Wänden.**

Kanlux SMART devices are so easy to configure, anybody can do it. You can use them with other devices you are already using - lamps, heaters, outlets - as well as add new devices, like cameras or sensors. That lets you start control your home right now - no renovations, reconstructions and hammering the walls.



*photometrische Daten finden Sie auf:  
photometric data you can find on:*

► [kanlux.com](http://kanlux.com)

### **Steuerung der Kanlux SMART-Produkte mit der mobilen Anwendung SMART LIFE**

Control Kanlux SMART products  
with the SMART LIFE mobile application



# KANLUX SMART

FENSTER-/TÜRÖFFNUNGSMELDER ► DOOR/WINDOW SENSOR



S SENSOR ON/OFF INT



S SENSOR ON/OFF INT | **34942** | 5905339349422 | 2 x 1,5 DC | 2 x AAA



Ein offenes Fenster oder eine Terrassentür - wir fragen uns oft, ob wir sie geschlossen haben, als wir das Haus verließen. Der Fenster-/Türöffnungsmelder zeigt uns ihren Status an. Durch die Anbringung an der Haustür, der Terrasse, dem Balkon oder dem Fenster müssen wir uns nicht mehr fragen, ob zu Hause alles in Ordnung ist, wenn wir das Haus verlassen. Der Melder überprüft Fenster und Türen, und wir werden über eine App auf unserem Mobilgerät über jede Öffnung informiert. Ein Alarm informiert Sie, wenn die Batterie schwach ist. Mehr über Kanlux SMART erfahren Sie unter [www.kanluxsmart.com](http://www.kanluxsmart.com)

An open window or terrace door - each of us often wonders if we closed them after leaving the house. The window/door opening sensor will show you their status. By mounting it on the front, terrace, balcony or door, or on the window, you don't have to wonder if everything is alright at home when you go for a trip. The sensor will inspect the windows and doors, and an app on your mobile device will notify you if any of them is opened. An alarm will let you know when the battery is low. Learn more about Kanlux SMART at [www.kanluxsmart.com](http://www.kanluxsmart.com).

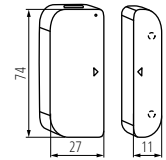

S SENSOR ON/OFF INT

# KANLUX SMART

BEWEGUNGSMELDER PIR ► PIR MOTION SENSOR



S SENSOR PIR INT 10M

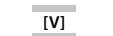

S SENSOR PIR INT 10M | **34940** | 5905339349408 | 2 x 3V DC / 5V USB | 2 x CR123A



Bewegungsmelder für den Innenbereich. Durch die Kopplung in der App mit ausgewählten SMART-Geräten schaltet der Bewegungsmelder nicht nur das Licht ein, wenn eine Bewegung erkannt wird, sondern löst auch jede programmierte Aktion aus - abhängig von den gekoppelten SMART-Geräten und der ihnen zugewiesenen Funktion. Der Melder verfügt sowohl über eine Batterie als auch über eine USB-Ladefunktion. Ein Alarm informiert Sie, wenn die Batterie schwach ist. Mehr über Kanlux SMART erfahren Sie unter [www.kanluxsmart.com](http://www.kanluxsmart.com).

Motion detection sensor for indoor use. By pairing it in the app with selected SMART devices, it will not only turn on the light when motion is detected but it will also trigger any programmed action - depending on the SMART devices paired and the function assigned to them. The sensor is battery powered but it can also be charged via USB. An alarm will let you know when the battery is low. Learn more about Kanlux SMART at [www.kanluxsmart.com](http://www.kanluxsmart.com).

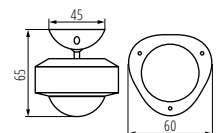

S SENSOR PIR INT 10M

Kanlux

# KANLUX SMART

ÜBERSCHWEMMUNGSMELDER ► FLOOD SENSOR



S SENSOR W INT



SSENSORWINT | 34941 | 5905339349415 | 2 x 1,5 DC | 2 x AAA



Ein Überschwemmungsmelder hilft, auf Wasser zu reagieren, das aus einem gebrochenen Rohr austritt, auf einen nicht zugeordneten Wasserhahn oder auf Überschwemmungen im Haus oder in der Wohnung, die wir nicht kontrollieren können. Der Melder sollte so platziert werden, dass er im Falle einer Überschwemmung Wasser erkennen kann. Er verfügt über einen eingebauten akustischen Alarm, aber die Informationen von der App werden auch auf dem Mobilgerät empfangen, selbst wenn man nicht zu Hause ist. Ein Alarm informiert Sie, wenn die Batterie schwach ist. Mehr über Kanlux SMART erfahren Sie unter [www.kanluxsmart.com](http://www.kanluxsmart.com).

A flood sensor will help you react to water leaking from a broken pipe, a running faucet, or in the event of flooding in the house or apartment caused by external factors. The sensor should be placed in such a location as to enable water detection in the event of flooding. It has a built-in acoustic alarm, but you will also get the information from the app on your mobile device, even when you are away from home. The alarm will let you know when the battery is low. Learn more about Kanlux SMART at [www.kanluxsmart.com](http://www.kanluxsmart.com).

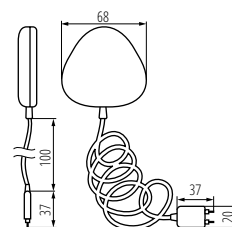

S SENSOR W INT



Kanlux

# KANLUX SMART

STECKDOSENADAPTER ► SOCKET ADAPTOR



Dank des Steckdosenadapters können Sie Geräte ohne SMART-Funktionen (z.B. Bügeleisen) steuern (Ein/Aus Funktion). Wir können auch eine Abfolge von Maßnahmen unserer Wahl einstellen. Die Grundfunktion ist ein/aus, aber der Adapter hat auch eine eingebaute Uhr (Wochenuhr mit Kalender), Zufallsfunktionen und eine Timer/Countdown-Funktion. Damit können Sie verschiedene Geräte so programmieren, dass sie sich zu bestimmten Zeiten ein- und auszuschalten, auch wenn Sie nicht zu Hause sind. Darüber hinaus hat der Adapter eine Funktion zur Messung des Energieverbrauchs (des angeschlossenen Gerätes) zu messen. Erfahren Sie mehr über Kanlux SMART unter [www.kanluxsmart.com](http://www.kanluxsmart.com).

Thanks to the socket adapter, you can control (on/off function) devices without SMART functions (e.g.: an iron). We can also set a sequence of actions of our choice. The basic function is on/off, but the adapter also has a built-in clock (weekly clock with a calendar), random functions and a timer/countdown function. This allows you to program different devices to turn on and off at specific times, even when you are not at home. In addition, the adapter has a function to measure the energy consumption (of the device connected to it). Learn more about Kanlux SMART at [www.kanluxsmart.com](http://www.kanluxsmart.com).



S AD GN SCH 10A PM



S AD GN 16A PM

			In [A]
S AD GN SCH 10A PM	33701	5905339337016	10
S AD GN 16A PM	33703	5905339337030	16

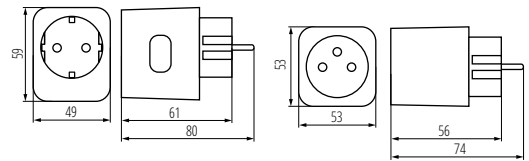

S AD GN SCH 10A PM

S AD GN 16A PM



Kanlux

# KANLUX SMART

ÖFFNUNGS- UND SCHLIEßSENSOR ► GARAGE DOOR RELAY



S SWITCH G DOOR



S SWITCH G DOOR | **34950** | 5905339349507 | weiß | white



Relais zur Steuerung des Tores mit einem Öffnungs- und Schließsensor. Es kann in einer intelligenten Umgebung mit anderen speziellen oder virtuellen Tasten durch zugewiesene Funktionen wie Schließen oder Öffnen zusammenarbeiten. Mehr über Kanlux SMART erfahren Sie unter [www.kanluxsmart.com](http://www.kanluxsmart.com).

Relay for controlling gates with an open and close sensor. It can work in a smart environment with other dedicated or virtual buttons by assigned functions - such as close or open. Learn more about Kanlux SMART at [www.kanluxsmart.com](http://www.kanluxsmart.com).

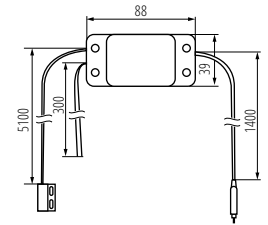

S SWITCH G DOOR

Kanlux

# KANLUX SMART

SCHALTRELAIS ► SWITCHBOX RELAY



S SWITCH ON/OFF



S SWITCH ON/OFF | **34948** | 5905339349484 | weiß | white



Ein/Aus-Relais, Unterputzmontage (fi 60 Dosen). Das Relais ermöglicht es, die Stromkreise von Steckdosen oder Lichtschaltern zu steuern und ihnen eine SMART-Funktion zu verleihen, ohne dass eine zusätzliche Installation zwischen ihnen verlegt werden muss. Mehr über Kanlux SMART erfahren Sie unter [www.kanluxsmart.com](http://www.kanluxsmart.com).

Flush-mounted on/off relay (fi 60 boxes). It allows you to control the circuits of plug-in sockets or light switches, giving them the SMART function without requiring additional installation between them. Learn more about Kanlux SMART at [www.kanluxsmart.com](http://www.kanluxsmart.com).

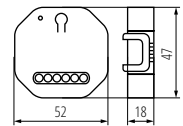

S SWITCH ON/OFF

Kanlux

# KANLUX SMART

SCHALTRELAIS ► SWITCHBOX RELAY



S SWITCH SHUTTER



S SWITCH SHUTTER | **34949** | 5905339349491 | weiß | white



Relais zur Steuerung der Motoren von Rollläden und Jalousien, Unterputzmontage (fi 60 Dosen). Das Relais ermöglicht die Steuerung von Rollläden über die auf einem mobilen Gerät installierte App. Mehr über Kanlux SMART erfahren Sie unter [www.kanluxsmart.com](http://www.kanluxsmart.com).

Relay for controlling motors of flush-mounted roller blinds and shutters (fi 60 boxes). It allows you to control roller blinds from the level of the application installed on your mobile device. Learn more about Kanlux SMART at [www.kanluxsmart.com](http://www.kanluxsmart.com).

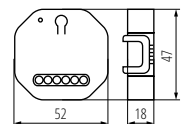

S SWITCH SHUTTER



# ***Kanlux***



**ELEKTROINSTALLATIONSZUBEHÖR**  
ELECTRICAL INSTALLATION EQUIPMENT

**Sie achten auf die richtigen Parameter, Effizienz und Wärme-, Kurzschluss- und Überlastschutz. Wir bieten Ihnen Produkte, die für diese Aufgaben konzipiert sind. Wir sorgen für Komfort, Zuverlässigkeit und Sicherheit.**

You want the properly adjusted parameters, efficiency and thermal, short-circuit and overload protection. We give you products designed for these tasks. We ensure comfort, reliability and safety.



*photometrische Daten werden Sie auf:  
photometric data you can find on:*

► [kanlux.com](https://www.kanlux.com)

# SQMOTION

BEWEGUNGSMELDER ► MW MOTION SENSOR



SQMOTION-W



SQMOTION-B

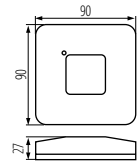
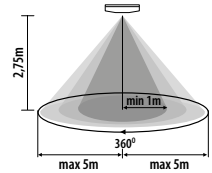

SQMOTION

Der SQMOTION ist ein Mikrowellen-Sensor. Sein modernes Design lässt ihn in jeder Situation gut aussehen. Erhältlich in zwei Farben, Aufputz-Montage.

Material: Kunststoff

Microwave motion sensor, modern design makes it look great in any application. Available in two colors, surface-mounted installation.

Material: plastic

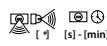

SQMOTION-W	<b>37360</b>	5905339373601	800	Deckenmontage, Wandmontage	ceiling mounted, wall mounted	360	10-12	Mikrowellen-   microwave
SQMOTION-B	<b>37361</b>	5905339373618	800	Deckenmontage, Wandmontage	ceiling mounted, wall mounted	360	10-12	Mikrowellen-   microwave

[V] 220-240 AC	[Hz] 50	IP 20			 max 8	 3-2000	 5+25		 0,75+1,5	CE	EAC	UK CA	
-------------------	------------	----------	--	--	-----------	------------	----------	--	--------------	----	-----	----------	--

# ALER-N

BEWEGUNGSMELDER PIR ► PIR MOTION SENSOR



ALER-N-W



ALER-N-B

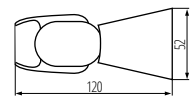
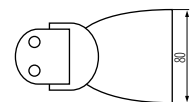
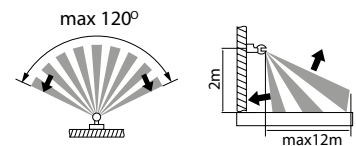

ALER-N

Der ALER-N ist das neueste Modell von Infrarotsensoren in der ALER Familie. Der maximale Erfassungsbereich von 12 Meter und die hohe Schutzart IP 65 macht ihn zu einem Allroundmodell. Erhältlich in zwei Farben, Aufbau-Wandmontage.

Material: Kunststoff

The latest model of an infrared motion sensor in the ALER family. A maximum detection range of 12m and a high IP65 rating make it a versatile solution for many applications. Available in two colors, wall-mounted installation.

Material: plastic



ALER-N-W	<b>37362</b>	5905339373625	1200	Wandmontage	wall mounted	120	PIR	10-15
ALER-N-B	<b>37363</b>	5905339373632	1200	Wandmontage	wall mounted	120	PIR	10-15

[V] 220-240 AC	[Hz] 50	IP 65			 max 12	 3-2000	 -20+40		 0,75+1,5	CE	EAC	UK CA	
-------------------	------------	----------	--	--	------------	------------	------------	--	--------------	----	-----	----------	--

**Kanlux**

# ZONA MINI

BEWEGUNGSMELDER PIR ► PIR MOTION SENSOR



ZONA MINI

Der Kanlux ZONA MINI ist ein Infrarot-Bewegungsmelder der sich Dank seiner kompakten Bauform (nur 76 mm Durchmesser) perfekt in jeden Raum integriert.

Material: Kunststoff

The ZONA MINI infrared motion sensor, thanks to its compact dimensions (only 76mm in diameter), will perfectly and subtly blend into any room.

Material: plastic

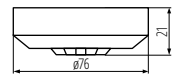
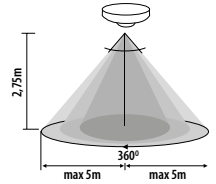

ZONA MINI



ZONA MINI-W | **37364** | 5905339373649 | 200 | Deckenmontage | ceiling mounted | H360 | PIR | 10-15

[V]	[Hz]	IP								CE	ERC	UK	
220-240 AC	50	20			max 8	3-2000	5+25		0,75+1,5				

**Kanlux**

# ZONA MINI WT

BEWEGUNGSMELDER PIR ► PIR MOTION SENSOR



ZONA MINI WT

ZONA MINI WT ist eine Erweiterung der Familie der kompakten Infrarot-Bewegungsmelder Sensoren. Die WT-Version (wasserdicht) zeichnet sich durch eine hohe Schutzart IP65 aus und erweitert damit den Anwendungsbereich.

Material: Kunststoff

ZONA MINI WT is an extension of the family of compact infrared motion sensors. The WT (watertight) version is characterized by a high IP65 rating, further expanding its range of applications.

Material: plastic

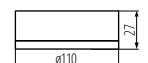
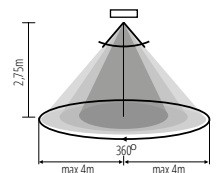

ZONA MINI WT



ZONA MINI WT-W | **37365** | 5905339373656 | 2000 | Deckenmontage | ceiling mounted | H360 | PIR | 10-30

[V]	[Hz]	IP								CE	ERC	UK	
220-240 AC	50	65/20			max 8	3-2000	-20+40		0,75+1,5				

# SENTO-O

BEWEGUNGSMELDER PIR ► PIR MOTION SENSOR



SENTO-O-WT-W



SENTO-O-WT-B

Kanlux SENTO ist ein elektronischer Sensor zur Bewegungserkennung. Seine Einzigartigkeit liegt darin, dass drei Infrarotdetektoren in einem Sensor installiert sind. Dies gewährleistet eine beispiellose Empfindlichkeit und ermöglicht sogar das Erkennen kleinster Bewegungen. Kanlux SENTO wird aufgrund seiner ungewöhnlichen Eigenschaften als Präsenzmelder bezeichnet.

Material: Kunststoff

Kanlux SENTO is an electronic sensor for movement detection. Its exceptionality lies in the fact that as many as three infrared detectors are installed in one sensor. This guarantees an unprecedented sensitivity and allows you to capture even the slightest movement. Kanlux SENTO, due to its unusual. The additional advantage is universal installation - flush-mounted and surface-mounted.

Material: plastic

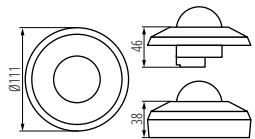
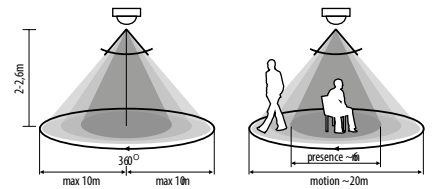

SENTO-O-WT



SENTO-O-WT-W	<b>37366</b>	5905339373663	2000	Deckenmontage, Deckeneinbau	ceiling mounted, Recessed mount in the ceiling	H360	10-30	3xPIR
SENTO-O-WT-B	<b>37367</b>	5905339373670	2000	Deckenmontage, Deckeneinbau	ceiling mounted, Recessed mount in the ceiling	H360	10-30	3xPIR

[V]	[Hz]	IP	🏠	📏	📏 [m]	🌡️ [°C]	📏 [mm]	CE	EAC	UK CA	🌱
220-240 AC	50	44/20		max 20	3-2000	-20+40	0,75+1,5				

# SENSQUARE

BEWEGUNGSMELDER PIR ► PIR MOTION SENSOR



SENSQUARE-W



SENSQUARE-B

Die SENSQUARE-Sensoren sind für die Wandmontage konzipiert und verwenden Infrarot-Technologie. Die Kombination aus einem einzigartigen Design, einem großen Erfassungsbereich und der Schutzart IP54 ermöglicht die Anpassung des Sensors an viele Anwendungen. Ein weiterer Vorteil des Sensors ist das mitgelieferte Zubehör, das die Montage des Sensors sowohl an Innen- als auch Außencken ermöglicht. Erhältlich in schwarz und weiß.

Material: Kunststoff

SENSQUARE sensors are designed for wall mounting and use infrared technology. The combination of a unique design, a wide detection range, and an IP54 rating allows for the adaptation of the sensor to many applications. An additional advantage of the sensor is the included accessory that allows for mounting the sensor on both internal and external corners. Available in black and white..

Material: plastic

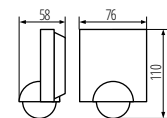
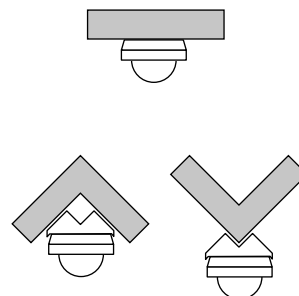
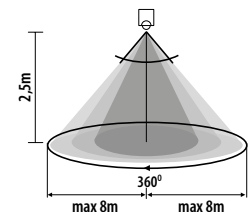

SENSQUARE

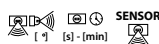

SENSQUARE-W	<b>37368</b>	5905339373687	1200	Wandmontage	wall mounted	H360	10-15	PIR
SENSQUARE-B	<b>37369</b>	5905339373694	1200	Wandmontage	wall mounted	H360	10-15	PIR

[V]	[Hz]	IP	🏠	📏	📏 [m]	🌡️ [°C]	📏 [mm]	CE	EAC	UK CA	🌱
220-240 AC	50	54		max 8	3-2000	-20+40	0,75+1,5				

**Kanlux**

# MERGE-WT

BEWEGUNGSMELDER PIR ► PIR MOTION SENSOR

Kompakter Infrarot-Bewegungsmelder MERGE-WT. Die maximale Erfassungsreichweite beträgt 10 Meter, der horizontale Erfassungswinkel 360 Grad. Sie können die Beleuchtungsdauer und die Lichtintensität einstellen, mit der der Sensor arbeitet. Der Vorteil des Sensors ist seine hohe Schutzart IP65.

Material: Kunststoff

Compact infrared motion sensor MERGE-WT. The maximum detection range is 8 meters, and the horizontal detection angle is 360 degrees. You can adjust the lighting duration and the light intensity level at which the sensor operates. The sensor's advantage is its high IP65 rating.

Material: plastic



MERGE-WT-O-W

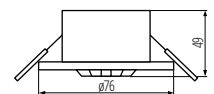
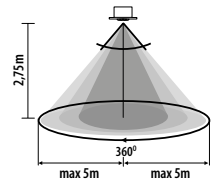

MERGE-WT-O-W

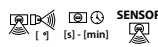

MERGE-WT-O-W | **37370** | 5905339373700 | 1200 | Deckeneinbau | Recessed mount in the ceiling | H360 | 10-30 | PIR

[V]	[Hz]	IP	🏠	◻	max 8	3-2000	-20+40	📦	0,75+1,5	CE	ERC	UK CA	⬇️
220-240 AC	50	65\20											

**Kanlux**

# SLICK JQ

BEWEGUNGSMELDER PIR ► PIR MOTION SENSOR

Kanlux SLICK JQ ist ein Bewegungsmelder mit einer maximalen Reichweite von 12 Metern. Die Beleuchtungszeit und Umgebungshelligkeit, bei der der Sensor arbeitet, ist einstellbar.

Material: Kunststoff

Kanlux SLICK JQ is a motion detector whose maximum detection range comes to 12 metres. You can set adjustments of the lighting time and light intensity level at which the detector works.

Material: plastic



SLICK JQ-L-W



SLICK JQ-L-B

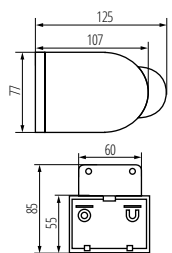
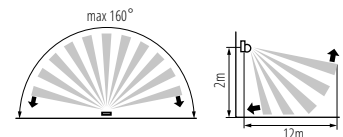

SLICK JQ

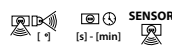

SLICK JQ-L-W | **08390** | 5905339083906 | 1200 | Wandmontage | wall mounted | H160\V20 | 8-10 | PIR  
 SLICK JQ-L-B | **08391** | 5905339083913 | 1200 | Wandmontage | wall mounted | H160\V20 | 8-10 | PIR

[V]	[Hz]	IP	🏠	◻	max 12	3-2000	-10+40	📦	1+2,5	CE	ERC	UK CA	⬇️
220-240 AC	50	44											

# ALER MINI

BEWEGUNGSMELDER PIR ► PIR MOTION SENSOR



ALER MINI-W

Der ALER MINI-W ist ein kleiner Infrarotsensor mit einem beeindruckenden und minimalistischen Design. Der Sensor hat einen horizontalen Winkel von 140°, einen vertikalen Winkel von 45° und kann dank seiner einfachen mechanischen Verstellung (vertikal 45°, horizontal 90°) an Ihre Bedürfnisse angepasst werden. Er hat eine hohe Schutzart (IP44), was bedeutet, dass der Sensor an Orten installiert werden kann, die direkt der Witterung ausgesetzt sind.

Maximale Reichweite der Bewegungserkennung beträgt 8m

Maximaler horizontaler Erkennungswinkel des Bewegungssensors beträgt 140°

Regulierbare Lichtzeit von 10 Sekunden bis 15 Minuten

Es besteht die Möglichkeit, die Umgebungslichtintensität, bei der das Gerät arbeitet, einzustellen.

Material: Kunststoff

ALER MINI-W sensor is a small infrared sensor with attractive and minimalist design. The horizontal angle of the sensor work comes to 140°, and vertical 45°, and thanks to easy mechanical adjustment (vertical 45°, level 90°) it can be adapted to your needs. Owing to the high class of tightness (IP44), this sensor can be mounted in places directly exposed to weather conditions.

Maximum movement detection up to 8m

Maximum horizontal angle of operation of the motion sensor – 140°

Light on time adjustable from 10s to 15min

Capability to set the light intensity of the environment in which the device works

Material: plastic

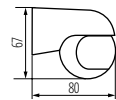
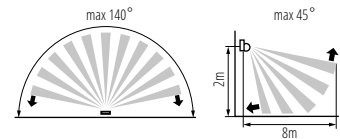

ALER MINI



ALER MINI-W | 23450 | 5905339234506 | 800 | Wandmontage | wall mounted | H140°V45 | 10-15 | PIR

[V] 220-240 AC	[Hz] 50	IP 44			 max 8	 3-2000	 -20+40	 1+2,5	CE	EAC	UK	
-------------------	------------	----------	--	--	-----------	------------	------------	-----------	----	-----	----	--

# ALER JQ

BEWEGUNGSMELDER PIR ► PIR MOTION SENSOR



ALER JQ-30-W



ALER JQ-30-B

Kanlux ALER JQ ist ein Bewegungsmelder mit einer maximalen Reichweite von 12 Metern. Die Beleuchtungszeit und Umgebungs-helligkeit, bei der der Sensor arbeitet, ist einstellbar.

Material: Kunststoff

Kanlux ALER JQ is a motion detector whose maximum detection range comes to 12 metres. You can set adjustments of the lighting time and light intensity level at which the detector works.

Material: plastic

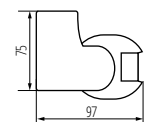
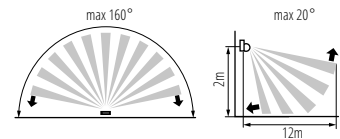

ALER JQ-30



ALER JQ-30-W | 00460 | 5905339004604 | 1200 | Wandmontage | wall mounted | H160°V20 | 8-7 | PIR  
 ALER JQ-30-B | 00461 | 5905339004611 | 1200 | Wandmontage | wall mounted | H160°V20 | 8-7 | PIR

[V] 220-240 AC	[Hz] 50	IP 44			 max 12	 3-2000	 -20+40	 1+2,5	CE	EAC	UK	
-------------------	------------	----------	--	--	------------	------------	------------	-----------	----	-----	----	--

**Kanlux**

# ZONA JQ-37

BEWEGUNGSMELDER PIR ► PIR MOTION SENSOR



ZONA JQ-37-B



ZONA JQ-37-W



ZONA JQ-37-B	<b>00463</b>	5905339004635	1200	Deckenmontage	ceiling mounted	H360°V120	15-7	PIR
ZONA JQ-37-W	<b>00464</b>	5905339004642	1200	Deckenmontage	ceiling mounted	H360°V120	15-7	PIR

<b>[V]</b> 220-240 AC	<b>[Hz]</b> 50	<b>IP</b> 20			<b>(m)</b> max 10	<b>(s)</b> 3-2000		<b>(mm)</b> 1+2,5				
--------------------------	-------------------	-----------------	--	--	----------------------	----------------------	--	----------------------	--	--	--	--

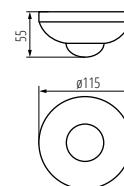
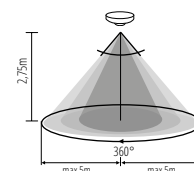

ZONA JQ-37

Kanlux ZONA JQ-37 ist ein Bewegungsmelder mit einer maximalen Erfassungsreichweite von 10 Metern. Sie können die Beleuchtungszeit und die Lichtintensität, mit der der Sensor arbeitet, einstellen. Er ist in weißer und schwarzer Ausführung erhältlich.

Maximale Bewegungserfassung bis zu 10m

Maximaler horizontaler Arbeitswinkel des Bewegungssensors - 360°

Maximaler vertikaler Betriebswinkel des Bewegungssensors 120°

Einschaltdauer des Lichts einstellbar von 15s bis 7min

Möglichkeit der Einstellung der Lichtintensität der Umgebung, in der das Gerät arbeitet

Material: Kunststoff

Kanlux ZONA JQ-37 is a motion sensor whose maximum detection range is 10 meters. We can adjust the lighting time and the light intensity level at which the sensor works. It is available in white and black colors.

Maximum movement detection up to 10m

Maximum horizontal angle of operation of the motion sensor – 360°

Maximum vertical angle of operation of the motion sensor 120°

Light on time adjustable from 15s do 7min

Capability to set the light intensity of the environment in which the device works

Material: plastic

**Kanlux**

# ZONA

BEWEGUNGSMELDER PIR ► PIR MOTION SENSOR



ZONA FLAT-W



ZONA FLAT-W	<b>23452</b>	5905339234520	2000	Deckenmontage	ceiling mounted	H360°V120	10-15	PIR
-------------	--------------	---------------	------	---------------	-----------------	-----------	-------	-----

<b>[V]</b> 220-240 AC	<b>[Hz]</b> 50	<b>IP</b> 20			<b>(m)</b> max 8	<b>(s)</b> 3-2000	<b>(°C)</b> 5+25	<b>(mm)</b> 0,75+1,5				
--------------------------	-------------------	-----------------	--	--	---------------------	----------------------	---------------------	-------------------------	--	--	--	--

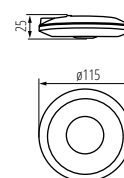
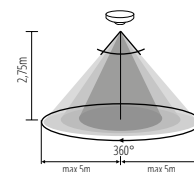

ZONA FLAT

Kanlux ZONA FLAT ist ein Bewegungsmelder mit einer maximalen Reichweite von 8m. Sein maximaler horizontaler Wirkungswinkel beträgt 360 Grad. Im ZONA-Sensor können Sie die Beleuchtungszeit von 10s bis 15min und auch die Umgebungshelligkeit, mit der das Gerät arbeiten soll, einstellen.

Maximale Reichweite der Bewegungserkennung beträgt 8m

Maximaler horizontaler Erkennungswinkel des Bewegungssensors beträgt 360°

Regulierbare Lichtzeit von 10 Sekunden bis 15 Minuten

Es besteht die Möglichkeit, die Umgebungslichtintensität, bei der das Gerät arbeiten soll, einzustellen.

Bewegungserkennung 0.6-1.5m/s

Maximaler vertikaler Erkennungswinkel des Bewegungssensors beträgt 120°

Material: Kunststoff

Kanlux ZONA FLAT is a motion detector with maximum motion detection range of 8m. In turn, its maximum horizontal angle of work comes to 360 degrees. In the ZONA sensor, you can adjust the time of lighting from 10s to 15min as well as set the surrounding light intensity level at which the device will work.

Maximum movement detection up to 8m

Maximum horizontal angle of operation of the motion sensor – 360°

Light on time adjustable from 10s to 15min

Capability to set the light intensity of the environment in which the device works

Motion detection 0.6...1.5m/s

Maximum vertical angle of operation of the motion sensor 120°

Material: plastic



# MERGE JQ

BEWEGUNGSMELDER PIR ► PIR MOTION SENSOR



MERGE JQ-L

Kanlux MERGE JQ ist ein Bewegungsmelder mit einer maximalen Reichweite von 9 Metern. Die Beleuchtungszeit und Umgebungshelligkeit, bei der der Sensor arbeitet, ist einstellbar.

- Maximale Reichweite der Bewegungserkennung beträgt 9m
- Maximaler horizontaler Erkennungswinkel des Bewegungssensors beträgt 150°
- Maximaler vertikaler Erkennungswinkel des Bewegungssensors beträgt 60°
- regulierbare Lichtzeit von 10 Sekunden bis 7 Minuten
- Es besteht die Möglichkeit, die Umgebunglichtintensität, bei der das Gerät arbeitet, einzustellen.
- Ohmsche Last von bis zu 1200W, induktive Last von bis zu 400W
- Material: Kunststoff

Kanlux MERGE JQ is a motion detector whose maximum detection range comes to 5 metres. The horizontal angle of the detector work comes to 360 degrees. You can set adjustments of the lighting time and light intensity level at which the detector works.

- Maximum movement detection up to 9m
- Maximum horizontal angle of operation of the motion sensor – 150°
- Maximum vertical angle of operation of the motion sensor – 60°
- Light on time adjustable from 10s to 7min
- Capability to set the light intensity of the environment in which the device works
- Max 1200W resistive load, max. 400W inductive load
- Material: plastic

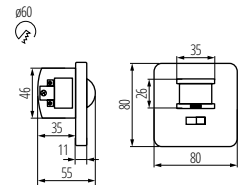
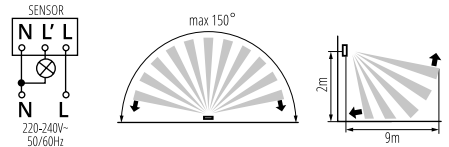

MERGE JQ-L



MERGE JQ-L | 07690 | 5905339076908 | 1200 | Wandeinbau | Recessed mount in the wall | H150V60 | 10-7 | PIR

[V]	[Hz]	IP	House icon	Mount icon	max 9	lx	°C	mm	CE	ERC	UK	Recycling icon
220-240 AC	50	20				3-2000	5+25	1+2,5				

# MARID JQ

BEWEGUNGSMELDER PIR ► PIR MOTION SENSOR



MARID JQ-L

Kanlux MARID JQ ist ein Bewegungsmelder mit einer maximalen Reichweite von 12 Metern. Die Beleuchtungszeit und Umgebungshelligkeit, bei der der Sensor arbeitet, ist einstellbar. Der Sensor kann auch durch ein akustisches Signal ausgelöst werden.

- Maximale Reichweite der Bewegungserkennung beträgt 12m
- Maximaler horizontaler Erkennungswinkel des Bewegungssensors beträgt 150°
- Maximaler vertikaler Erkennungswinkel des Bewegungssensors beträgt 30°
- Regulierbare Lichtzeit von 10 Sekunden bis 7 Minuten
- Es besteht die Möglichkeit, die Umgebunglichtintensität, bei der das Gerät arbeitet, einzustellen.
- Bewegungserkennung 0.3...3m/s (1...10km/h)
- Einstellung der Empfindlichkeit im Bereich von 3 bis 2000 lx
- Möglichkeit der Betätigung des Sensors durch akustisches Signal im Bereich von 30 bis 90 dB
- Nur für ohmsche Lasten ausgelegt
- Material: Kunststoff

Kanlux MARID JQ is a motion detector whose maximum detection range comes to 12 metres. You can set adjustments of the lighting time and light intensity level at which the detector works. The detector can be activated by means of sound signal too.

- Maximum movement detection up to 12m
- Maximum horizontal angle of operation of the motion sensor – 150°
- Maximum vertical angle of operation of the motion sensor – 30°
- Light on time adjustable from 10s to 7min
- Capability to set the light intensity of the environment in which the device works
- Motion detection 0.3...3m/s (1...10km/h)
- Sensitivity adjustment in the range of 3...1000lx
- Capability to activate the sensor with a 30-90db sound signal
- Designed only for resistive loads
- Material: plastic

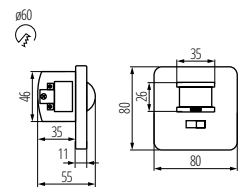
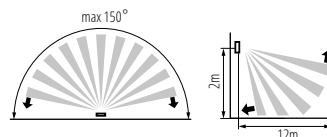
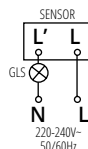

MARID JQ-L



MARID JQ-L | 08910 | 5905339089106 | 40-500 | Wandeinbau | Recessed mount in the wall | H150V30 | 10-7 | PIR

[V]	[Hz]	IP	House icon	Mount icon	max 12	lx	°C	mm	CE	ERC	UK	Recycling icon
220-240 AC	50	20				3-2000	5+25	0,75+2,5				

**Kanlux**

# ROLF JQ

BEWEGUNGSMELDER ► MW MOTION SENSOR



ROLF JQ-L

Kanlux ROLF JQ ist ein Bewegungsmelder mit einer maximalen Reichweite von 8 Metern. Der horizontale Winkel des Sensors beträgt 360 Grad. Die Beleuchtungszeit und Umgebungshelligkeit, bei der der Sensor arbeitet, ist einstellbar.

- Maximale Reichweite der Bewegungserkennung beträgt 8m
- Maximaler horizontaler Erkennungswinkel des Bewegungssensors beträgt 360°
- Maximaler vertikaler Erkennungswinkel des Bewegungssensors beträgt 160°
- regulierbare Lichtzeit von 5 Sekunden bis 12 Minuten
- Es besteht die Möglichkeit, die Umgebunglichtintensität, bei der das Gerät arbeitet, einzustellen.
- Einstellung der Empfindlichkeit im Bereich von 5 bis 2000 lx
- Bewegungserkennung 0.3...3m/s (1...10km/h)
- Material: Kunststoff

Kanlux ROLF JQ is a motion detector. The horizontal angle of the detector work comes to 360 degrees. You can set adjustments of the lighting time and light intensity level at which the detector works.

- Maximum movement detection up to 8m
- Maximum horizontal angle of operation of the motion sensor – 360°
- Maximum vertical angle of operation of the motion sensor – 160°
- Light on time adjustable from 5s to 12min
- Capability to set the light intensity of the environment in which the device works
- Sensitivity adjustment in the range of 2...2000lx
- Motion detection 0.3...3m/s (1...10km/h)
- Material: plastic

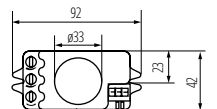
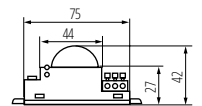
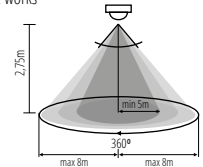

ROLF JQ-L



ROLF JQ-L | **08820** | 5905339088208 | 1200 | Wandmontage, Deckenmontage, Bodenmontage | wall mounted, ceiling mounted, surface mounted | H360V160 | 5-12 | Mikrowellen- | microwave

[V]	[Hz]	IP	□	max 8	2-2000	5+25	1+2,5	CE	EAC	UK	↓
220-240 AC	50	20	□	(m)	(lx)	°C	(mm²)				

**Kanlux**

# ROLF JQ

BEWEGUNGSMELDER ► MW MOTION SENSOR



ROLF MINI JQ-L

Kanlux ROLF JQ ist ein Bewegungsmelder mit einer maximalen Reichweite von 10 Metern. Der horizontale Winkel des Sensors beträgt 360 Grad. Die Beleuchtungszeit und Umgebungshelligkeit, bei der der Sensor arbeitet, ist einstellbar.

- Maximale Reichweite der Bewegungserkennung beträgt 10m
- Maximaler horizontaler Erkennungswinkel des Bewegungssensors beträgt 360°
- Maximaler vertikaler Erkennungswinkel des Bewegungssensors beträgt 140°
- regulierbare Lichtzeit von 10 Sekunden bis 30 Minuten
- Es besteht die Möglichkeit, die Umgebunglichtintensität, bei der das Gerät arbeitet, einzustellen.
- Einstellung der Empfindlichkeit im Bereich von 2 bis 2000 lx
- Bewegungserkennung 0.3...3m/s (1...10km/h)
- Material: Kunststoff

Kanlux ROLF JQ is a motion detector. The horizontal angle of the detector work comes to 360 degrees. You can set adjustments of the lighting time and light intensity level at which the detector works.

- Maximum movement detection up to 10m
- Maximum horizontal angle of operation of the motion sensor – 360°
- Maximum vertical angle of operation of the motion sensor – 140°
- Light on time adjustable from 10s to 30min
- Capability to set the light intensity of the environment in which the device works
- Sensitivity adjustment in the range of 2...2000lx
- Motion detection 0.3...3m/s (1...10km/h)
- Material: plastic

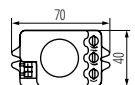
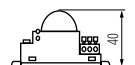
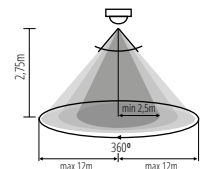

ROLF MINI JQ-L



ROLF MINI JQ-L | **08822** | 5905339088222 | 1200 | Wandmontage, Deckenmontage, Bodenmontage | wall mounted, ceiling mounted, surface mounted | H360V140 | 10-30 | Mikrowellen- | microwave

[V]	[Hz]	IP	□	max 10	2-2000	5+25	1+2,5	CE	EAC	UK	↓
220-240 AC	50	20	□	(m)	(lx)	°C	(mm²)				

# MERGE JQ

BEWEGUNGSMELDER PIR ► PIR MOTION SENSOR



MERGE JQ-0

Kanlux MERGE JQ ist ein Bewegungsmelder mit einer maximalen Reichweite von 5 Metern. Die Beleuchtungszeit und Umgebungshelligkeit, bei der der Sensor arbeitet, ist einstellbar.

- Maximale Reichweite der Bewegungserkennung beträgt 5m
- Maximaler horizontaler Erkennungswinkel des Bewegungssensors beträgt 360°
- Maximaler vertikaler Erkennungswinkel des Bewegungssensors beträgt 120°
- Regulierbare Lichtzeit von 5 Sekunden bis 6 Minuten
- Es besteht die Möglichkeit, die Umgebunglichtintensität, bei der das Gerät arbeitet, einzustellen.
- Ohmsche Last von bis zu 2000W, induktive Last von bis zu 800 W
- Material: Kunststoff

Kanlux MERGE JQ is a motion detector whose maximum detection range comes to 5 metres. The horizontal angle of the detector work comes to 360 degrees. You can set adjustments of the lighting time and light intensity level at which the detector works.

- Maximum movement detection up to 5m
- Maximum horizontal angle of operation of the motion sensor – 360°
- Maximum vertical angle of operation of the motion sensor – 120°
- Light on time adjustable from 5s to 6min
- Capability to set the light intensity of the environment in which the device works
- Max 2000W resistive load, max. 800W inductive load
- Material: plastic

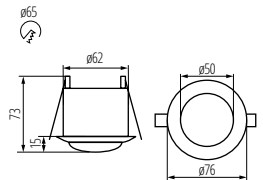
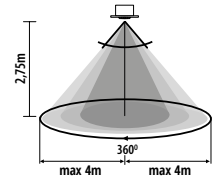

MERGE JQ-0



MERGE JQ-0 | 07691 | 5905339076915 | 2000 | Deckeneinbau | Recessed mount in the ceiling | H360V120 | 5-6 | PIR

[V]	[Hz]	IP	House icon	Square icon	max 5	3-2000	5+25	CE	ERAC	UKA	Recycling icon
220-240 AC	50	20									

# ROLF JQ

BEWEGUNGSMELDER ► MW MOTION SENSOR



ROLF JQ-0

Kanlux ROLF JQ ist ein Bewegungsmelder. Der horizontale Winkel des Sensors beträgt 360 Grad. Die Beleuchtungszeit und Umgebungshelligkeit, bei der der Sensor arbeitet, ist einstellbar.

- Maximale Reichweite der Bewegungserkennung beträgt 9m
- Maximaler horizontaler Erkennungswinkel des Bewegungssensors beträgt 360°
- Maximaler vertikaler Erkennungswinkel des Bewegungssensors beträgt 160°
- Regulierbare Lichtzeit von 6 Sekunden bis 12 Minuten
- Es besteht die Möglichkeit, die Umgebunglichtintensität, bei der das Gerät arbeitet, einzustellen.
- Einstellung der Empfindlichkeit im Bereich von 2 bis 2000lx
- Bewegungserkennung 0.3...3m/s (1...10km/h)
- Material: Kunststoff

Kanlux ROLF JQ is a motion detector. The horizontal angle of the detector work comes to 360 degrees. You can set adjustments of the lighting time and light intensity level at which the detector works.

- Maximum movement detection up to 9m
- Maximum horizontal angle of operation of the motion sensor – 360°
- Maximum vertical angle of operation of the motion sensor – 160°
- Light on time adjustable from 6s to 12min
- Capability to set the light intensity of the environment in which the device works
- Sensitivity adjustment in the range of 2...2000lx
- Motion detection 0.3...3m/s (1...10km/h)
- Material: plastic

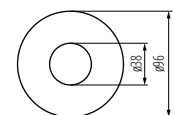
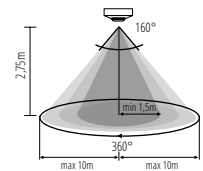

ROLF JQ-0



ROLF JQ-0 | 08821 | 5905339088215 | 1200 | Deckenmontage | ceiling mounted | H360V160 | 6-12 | Mikrowellen- / microwave

[V]	[Hz]	IP	House icon	Square icon	max 9	2-2000	5+25	0,75+1,5	CE	ERAC	UKA	Recycling icon
220-240 AC	50	20										

# Kanlux MERGE

BEWEGUNGSMELDER PIR ► PIR MOTION SENSOR



MERGE ADJ-O



Kanlux MERGE ADJ ist ein PIR-Bewegungsmelder mit einer maximalen Reichweite von 5m. Sein maximaler horizontaler Wirkungswinkel beträgt 360 Grad. Der MERGE ADJ-Sensor ermöglicht es Ihnen, Parametereinstellungen vorzunehmen, ohne den Sensor demontieren zu müssen.

- Maximale Reichweite der Bewegungserkennung beträgt 5m
- Maximaler horizontaler Erkennungswinkel des Bewegungssensors beträgt 360°
- Regulierbare Lichtzeit von 10 Sekunden bis 15 Minuten
- Es besteht die Möglichkeit, die Umgebungslichtintensität, bei der das Gerät arbeitet, einzustellen.
- Bewegungserkennung 0.6-1.5m/s
- Maximaler vertikaler Erkennungswinkel des Bewegungssensors beträgt 120°
- Material: Kunststoff

Kanlux MERGE ADJ is a PIR motion detector with maximum motion detection range of 5m. Its maximum horizontal angle of work comes to 360 degrees. In the MERGE ADJ sensor, you can adjust settings of parameters without a necessity to disassemble the detector.

- Maximum movement detection up to 5m
- Maximum horizontal angle of operation of the motion sensor – 360°
- Light on time adjustable from 10s to 15min
- Capability to set the light intensity of the environment in which the device works
- Motion detection 0.6..1.5m/s
- Maximum vertical angle of operation of the motion sensor 120°
- Material: plastic

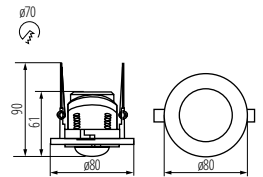
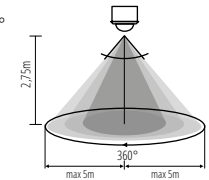

MERGE ADJ-O



MERGE ADJ-O | 23451 | 5905339234513 | 800 | Deckeneinbau | Recessed mount in the ceiling | H360°V120 | 10-15 | PIR

[V]	[Hz]	IP			(m)	(lx)	(°C)		(mm)	CE	EAC	UK	CA
220-240 AC	50	20			max 5	3-2000	5+25		0,75+1,5				

# Kanlux MERGE

BEWEGUNGSMELDER ► MW MOTION SENSOR



MERGE MW-L



Kanlux MERGE MW ist eine ästhetische und funktionelle Lösung. Die maximale Reichweite beträgt 9 Meter. Die Beleuchtungszeit und Umgebungs-helligkeit, bei der der Sensor arbeitet, ist einstellbar.

- Maximale Reichweite der Bewegungserkennung beträgt 9m
- Maximaler horizontaler Erkennungswinkel des Bewegungssensors beträgt 180°
- Regulierbare Lichtzeit von 10 Sekunden bis 12 Minuten
- Es besteht die Möglichkeit, die Umgebungslichtintensität, bei der das Gerät arbeitet, einzustellen.
- Bewegungserkennung 0.6-1.5m/s
- Maximaler vertikaler Erkennungswinkel des Bewegungssensors beträgt 180°
- Material: Kunststoff

Kanlux MERGE MW detector is an aesthetic and functional solution. The maximum detection range comes to 9 metres. You can set adjustments of the lighting time and light intensity level at which the detector works.

- Maximum movement detection up to 9m
- Maximum horizontal angle of operation of the motion sensor – 180°
- Light on time adjustable from 10s to 12min
- Capability to set the light intensity of the environment in which the device works
- Motion detection 0.6..1.5m/s
- Maximum vertical angle of operation of the motion sensor 180°
- Material: plastic

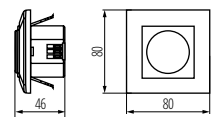
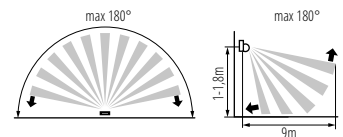

MERGE MW-L



MERGE MW-L | 23453 | 5905339234537 | 1200 | Wandeinbau | Recessed mount in the wall | 180 | 10-12 | Mikrowellen- | microwave

[V]	[Hz]	IP			(m)	(lx)	(°C)		(mm)	CE	EAC	UK	CA
220-240 AC	50	20			max 9	3-2000	5+25		0,75+1,5				

# Kanlux SENTO

BEWEGUNGSMELDER PIR ► PIR MOTION SENSOR



SENTO



Kanlux SENTO ist ein elektronischer Sensor zur Bewegungserkennung. Seine Einzigartigkeit liegt darin, dass drei Infrarotdetektoren in einem Sensor installiert sind. Dies gewährleistet eine beispiellose Empfindlichkeit und ermöglicht sogar das Erkennen kleinster Bewegungen. Kanlux SENTO wird aufgrund seiner ungewöhnlichen Eigenschaften als Präsenzmelder bezeichnet.

Material: Kunststoff

Kanlux SENTO is an electronic sensor for movement detection. Its exceptionality lies in the fact that as many as three infrared detectors are installed in one sensor. This guarantees an unprecedented sensitivity and allows you to capture even the slightest movement. Kanlux SENTO, due to its unusual features, is referred to as a presence detector.

Material: plastic

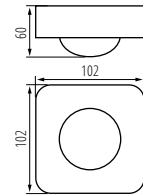
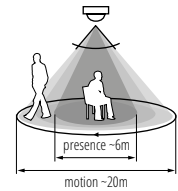
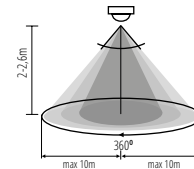

SENTO



SENTO | 26820 | 5905339268204 | 2000 | Wandmontage, Deckenmontage | wall mounted, ceiling mounted | H360V120 | 10-30 | 3xPIR

[V] 220-240 AC	[Hz] 50	IP 20	max 10	3-2000	5+25	0,75+1,5	CE	ERC	UK	↓
-------------------	------------	----------	--------	--------	------	----------	----	-----	----	---

# Kanlux SENZO

BEWEGUNGSMELDER PIR ► PIR MOTION SENSOR



SENZO



Kanlux SENZO ist ein PIR-Bewegungsmelder, der in automatischen Lichtschaltssystemen eingesetzt wird. Die spezielle Anordnung von zwei Infrarotsensoren in Kanlux SENZO ermöglicht den Einsatz in hohen Räumen wie Lagerhallen oder Produktionshallen. Seine vertikale Reichweite beträgt bis zu 10 Meter.

Material: Kunststoff

Kanlux SENZO is a PIR movement sensor used in automatic lighting switching systems. The special arrangement of two infrared sensors in Kanlux SENZO allows it to be used in high room installations, such as warehouses or production halls. Its vertical range is as much as 10 meters.

Material: plastic

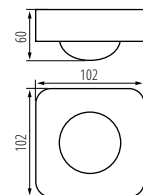
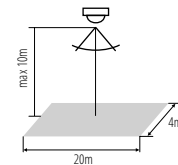

SENZO



SENZO | 26821 | 5905339268211 | 2000 | Wandmontage, Deckenmontage | wall mounted, ceiling mounted | H360V120 | 10-30 | 2xPIR

[V] 220-240 AC	[Hz] 50	IP 20	max 10	3-2000	5+25	0,75+1,5	CE	ERC	UK	↓
-------------------	------------	----------	--------	--------	------	----------	----	-----	----	---



## Kanlux AZ-10A

DÄMMERUNGSSCHALTER ► TWILIGHT SWITCH



AZ-10A



AZ-10A | 22371 | 5905339223715 | weiß | white | Wandmontage | wall mounted

[V]	[Hz]	In[A]	(VA)	⊕ [°C]	□	⌚	IP	CE	EAC	UKA	⌚
220-240 AC	50	10	2300	-20+40			20/65				

Kanlux AZ-10A ist ein Dämmerungsschalter. Er dient zum Ein- und Ausschalten von Beleuchtungskreisläufen oder anderen elektrischen Geräten in Abhängigkeit von der natürlichen Lichtintensität (Tag/Nacht).

Hysteresis -20Lx

Kanlux AZ-10 is a dusk and dawn light switch system. It is used for turning on and turning off lighting circuits or other electric receivers, depending on the natural light intensity level (day/night).

Hysteresis -20Lx

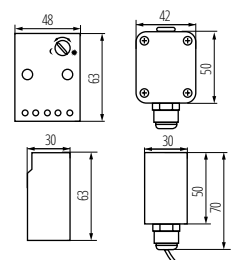

AZ-10A

# Kanlux CYBER

ZEITSCHALTUHR ► CONTROL TIMER / PROGRAMMER



CYBER TM-6



CYBER TM-6 | 01016 | 5905339010162 | 3600 | 10

[V]	[Hz]	In[A]	IP	⏚	⚡	CE	ERC	UK	⌚
220-240 AC	50	16(2)	20						

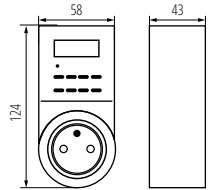

CYBER TM-6

Kanlux CYBER ist eine digitale Zeitschaltuhr ausgestattet mit einer Steckdose und einem 24-Stunden-Digitalprogrammierer. Dadurch lässt sich ein elektrischer Verbraucher automatisch ein- oder ausschalten. NICHT VERFÜGBAR FÜR DEN DEUTSCHEN MARKT!!!

Ausgestattet mit Backup-Stromversorgung

Möglichkeit der Programmierung bis zu 10 Ein- und Ausschaltvorgänge

Das Programmiergerät arbeitet im Wochen- und 24-Stunden-Modus

NICHT VERFÜGBAR FÜR DEN DEUTSCHEN MARKT!!!

Kanlux CYBER is an adapter of an extension socket with a 24-hour digital programmer. It makes it possible to programme turning on and turning off operations for connected devices at pre-set time.

Equipped with a memory keeping system

Up to 10 programmable on/off operations

The timer works in 24h and weekly mode

# Kanlux STER TS-MF

ZEITSCHALTUHR ► CONTROL TIMER / PROGRAMMER



STER TS-MF-1



STER TS-MF1 | 01001 | 5905339010018 | 3500 | 1

[V]	[Hz]	In[A]	IP	⏚	⚡	CE	ERC	UK	⌚
220-240 AC	50	16(2)	20						

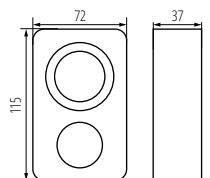

STER TS-MF-1

Kanlux STER TS-MF ist eine mechanische Zeitschaltuhr, die mit einer Steckdose und einem 24-Stunden Programmierer ausgestattet ist. Es ermöglicht, die Aktivierung und Deaktivierung der angeschlossenen Geräte für einen bestimmten Zeitraum zu programmieren. NICHT VERFÜGBAR FÜR DEN DEUTSCHEN MARKT!!!

Das Programmiergerät arbeitet im 24-Stunden Modus

Minimale Einschaltzeit / Ausschaltzeit beträgt 15 Minuten

Das Programmiergerät verfügt über die Funktion der Einschaltung von konstanter Belastung

NICHT VERFÜGBAR FÜR DEN DEUTSCHEN MARKT!!!

Kanlux STER TS-MF is an adapter of an extension socket with a 24-hour mechanical programmer. It makes it possible to programme turning on and turning off operations for connected devices at pre-set time.

The timer works in 24h mode

Minimum on/off time 15min

Timer has constant load switching capability

# Kanlux ADI

ELEKTRONISCHER TRANSFORMATOR ► CC POWER SUPPLY UNIT



ADI 350 1X3W

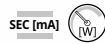

ADI 350 1x3W | 01440 | 5905339014405 | 350 | 1-3

[V]	[Hz]	CC	PRI [V]	SEC [V]	F	IP	House	□
220-240 AC	50		220-240	0,5-10 DC		20		
	[mm]	[m]	[°C]	CE	EAC	UK	CA	Recycle
	0,75	0,1	5+25					

Das elektronische Netzteil Kanlux ADI - mit einer maximal zulässigen Gehäusetemperatur von 75°C und einer Stromstabilisierung von 350mA DC - verfügt über einen eingebauten Kurzschluss- und Überlastschutz sowie einen Thermoschutz, der die Stromversorgung bei Temperaturen über 110°C abschaltet.

ADI 350 1-3W Stromstabilisierung 350mA DC

Maximal zulässige Gehäusetemperatur von 75 °C

Thermoschutz, der das Netzgerät nach Überschreitung der Temperatur von 110°C ausschaltet

Eingebauter Kurzschluss- und Überlastschutz

Das Netzgerät ist nicht für den Leerlaufbetrieb geeignet.

Material: Kunststoff

Kanlux ADI electronic power supply unit - with maximum permissible temperature of casing 75°C and current stabilization 350mA DC - has an embedded protection against short circuits and against overload as well as a thermal protection turning off the power supply unit when the temperature of 110°C is exceeded.

ADI 350 1-3W current stabilization 350mA DC

Maximum permissible housing temperature 75°C

Thermal protection shutting down the power supply after the temperature exceeds 110°C

Built-in circuit and overload protection

The power supply unit is not designed to work without load.

Material: plastic

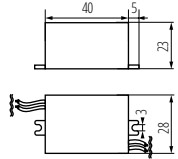

ADI 350 1X3W

# Kanlux POWELED

ELEKTRONISCHER TRANSFORMATOR ► CV POWER SUPPLY UNIT



POWELED P 12V 30W

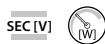

POWELED P 12V 30W	26810	5905339268105	12 DC	1-30
POWELED P 12V 60W	26811	5905339268112	12 DC	1-60
POWELED P 24V 30W	26815	5905339268150	24 DC	1-30
POWELED P 24V 60W	26816	5905339268167	24 DC	1-60
POWELED P 12V 100W	28961	5905339289612	12 DC	1-100
POWELED P 24V 100W	28962	5905339289629	24 DC	1-100
POWELED P 12V 150W	28963	5905339289636	12 DC	75-150
POWELED P 24V 150W	28964	5905339289643	24 DC	75-150
POWELED P 12V 200W	28965	5905339289650	12 DC	120-200
POWELED P 24V 200W	28966	5905339289667	24 DC	120-200

[V]	[Hz]	CV	PRI [V]	F	IP	House	□
220-240 AC	50		220-240		20		
	[mm]	[°C]	CE	EAC	UK	CA	Recycle
	0,5-1,5	5+25					

Kanlux POWELED ist ein elektronisches Gleichstromnetzteil. Je nach Ausführung des LED-Streifen, wird ein Netzteil mit 12V oder 24V Betriebsspannung verwendet.

Das Netzgerät ist nicht für den Leerlaufbetrieb geeignet.

Material: Kunststoff

Kanlux POWELED is an electronic constant-voltage power supply unit. It is used for powering LED belts such as LED S P or LED S B.

The power supply unit is not designed to work without load.

Material: plastic

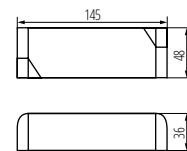

POWELED P 30W

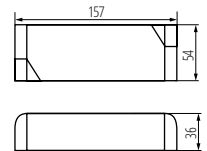

POWELED P 60W

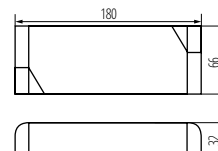

POWELED P 100W

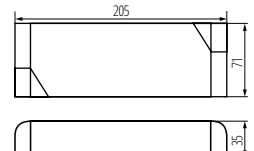

POWELED P 150W / POWELED P 200W



# Kanlux CIRCO

ELEKTRONISCHER TRANSFORMATOR ► CV POWER SUPPLY UNIT



CIRCO LED 12VDC



CIRCO LED 12VDC 0-10W	<b>24240</b>	5905339242402	12 DC	0-10
CIRCO LED 12VDC 0-15W	<b>24241</b>	5905339242419	12 DC	0-15

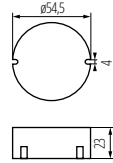

CIRCO LED 12VDC

# Kanlux DRIVE LED

ELEKTRONISCHER TRANSFORMATOR ► CV POWER SUPPLY UNIT



DRIVE LED N 15W 12V



DRIVE LED N 15W 12V	<b>23861</b>	5905339238610	220-240 AC	max 15
---------------------	--------------	---------------	------------	--------

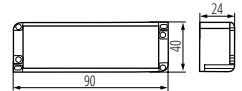

DRIVE LED N 15W 12V

# Kanlux SET

ELEKTRONISCHER TRANSFORMATOR ► SET ELECTRONIC TRANSFORMER



SET60-K

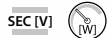

SET60-K	<b>01425</b>	5905339014252	11,5 AC	20-60
SET105-K	<b>01426</b>	5905339014269	11,5 AC	35-105

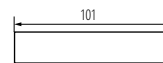

SET60-K

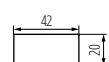
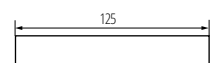

SET105-K

Kanlux CIRCO ist ein elektronisches 10 W oder 15 W DC-Netzteil. Es wird zur Versorgung von LED-Streifen (LEDS P oder LEDS B), sowie von LED-Wandbauleuchten - die DC-Version (z. B. Apus, Terra, Sabik, Sola, Liria) verwendet.

Das Netzgerät ist nicht für den Leerlaufbetrieb geeignet.

Kanlux CIRCO is an electronic constant-voltage power supply unit with power of 10 or 15 W. It is used for powering LED belts such as LEDS P or LEDS B.

The power supply unit is not designed to work without load.



Das Netzgerät ist nicht für den Leerlaufbetrieb geeignet.

Material: Kunststoff

The power supply unit is not designed to work without load.

Material: plastic

Das Produkt ist vorgesehen für die Stromversorgung von Halogenokomplex mit niedriger Spannung (12V).

Blindleistungsfaktor  $\cos\phi$  beträgt für SET60-K und SET105-K 0,99, für SET80LT, SET150-N und SET210-N 0,97

Maximal zulässige Gehäusetemperatur für SET60-K beträgt 80°C, für die übrigen Modelle 85°C

Thermoschutz, der das Modell SET80LT nach Überschreitung der Temperatur von 100°C, Modelle SET150-N und SET210-N nach Überschreitung der Temperatur von 110°C, Modelle SET60-K und SET105-K nach Überschreitung der Temperatur von 120°C ausschaltet

Eingebauter Kurzschluss- und Überlastschutz

Das Netzgerät ist nicht für den Leerlaufbetrieb geeignet.

product designed for feeding low voltage halogen light bulbs (12V)

Reactive power factor  $\cos\phi$  0.99 for SET60-K i SET105-K, for SET80LT, SET150-N and SET210-N – 0.97

Maximum permissible housing temperature 80°C for SET60-K, for other models – 85°C

Thermal protection shutting down SET80LT after the temperature exceeds 100°C, for SET150-N and SET210-N – after exceeding 110°C, for SET60-K and SET105-K – after exceeding 120°C

Built-in circuit and overload protection

The power supply unit is not designed to work without load.

**Kanlux**

# WIR ZL

KANALLÜFTER ► DUCTED FAN



WIR ZL100



WIR ZL120



WIR ZL100	<b>70961</b>	8594056490349	weiß   white
WIR ZL120	<b>70962</b>	8594056490356	weiß   white

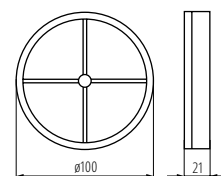

WIR ZL100

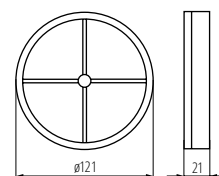

WIR ZL120

**Kanlux**

# TWISTER

KANALLÜFTER ► DUCTED FAN



TWISTER AOL100B

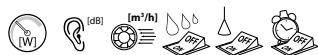

TWISTER AOL100B	<b>70926</b>	8594056490172	19	42	100	
TWISTER AOL100T	<b>70953</b>	8594056490202	19	42	100	ja   yes
TWISTER AOL120B	<b>70956</b>	8594056490226	20	42	150	
TWISTER AOL120T	<b>70960</b>	8594056490257	20	42	150	ja   yes

Die Ventilatoren der Kanlux TWISTER AOL-Serie sind in zwei Größen mit einem Durchmesser von 100 und 120 mm erhältlich. Sie sind aus Kunststoff, in der Farbe: weiß. Ihre Leistung beträgt 19 bzw. 20 W. Die Anzahl der Umdrehungen von jeder Größe beträgt 2550/min.

Kanlux TWISTER AOL series of fans is available in two sizes with diameter of 100 and 120 mm. They are made of plastic, in white colour. Their power is 19 and 20 W respectively. The number of rotations from each size comes to 2550/min.

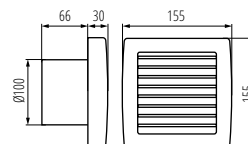

TWISTER AOL100

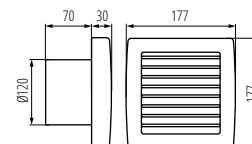

TWISTER AOL120



# Kanlux CYKLON

KANALLÜFTER ► DUCTED FAN



CYKLON EOL100



CYKLON EOL120



CYKLON EOL150



Die Ventilatoren der Kanlux CYKLON EOL-Serie sind in drei Größen mit einem Durchmesser von 100, 120 und 150 mm erhältlich. Sie sind aus Kunststoff, in der Farbe: weiß. Ihre Leistung beträgt 19, 20 und 22W. Die Anzahl der Umdrehungen von jeder Größe beträgt 2550/min.

Die Drehzahl beträgt 2550 U/min

Kanlux CYKLON EOL series of fans is available in three sizes with diameter of 100, 120 and 150mm. They are made of plastic, in white colour. Their power is 19, 20 and 22W respectively. The number of rotations from each size comes to 2550/min.

Rotation speed: 2550/min

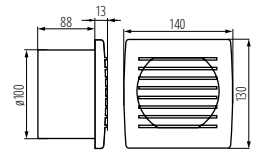

CYKLON EOL100

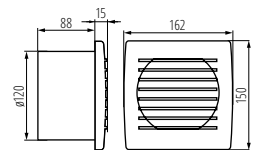

CYKLON EOL120

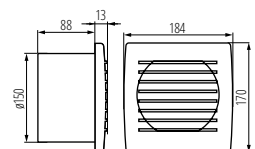

CYKLON EOL150



CYKLON EOL100	<b>70910</b>	8594056490011	19	38	100	ja   yes	Kabel mit Stecker   Cable terminated with a plug	
CYKLON EOL100B	<b>70911</b>	8594056490028	19	38	100		Anschlusswürfel   Terminal block	
CYKLON EOL120	<b>70915</b>	8594056490066	20	38	150	ja   yes	Kabel mit Stecker   Cable terminated with a plug	
CYKLON EOL120B	<b>70916</b>	8594056490073	20	38	150		Anschlusswürfel   Terminal block	
CYKLON EOL150	<b>70920</b>	8594056490110	22	38	200	ja   yes	Kabel mit Stecker   Cable terminated with a plug	
CYKLON EOL150B	<b>70921</b>	8594056490127	22	38	200		Anschlusswürfel   Terminal block	
CYKLON EOL100HT	<b>70936</b>	8594056490035	19	38	100	ja   yes	ja   yes	Anschlusswürfel   Terminal block
CYKLON EOL100P	<b>70937</b>	8594056490370	19	38	100	ja   yes		Anschlusswürfel   Terminal block
CYKLON EOL100T	<b>70938</b>	8594056490059	19	38	100		ja   yes	Anschlusswürfel   Terminal block
CYKLON EOL120HT	<b>70941</b>	8594056490080	20	38	150	ja   yes	ja   yes	Anschlusswürfel   Terminal block
CYKLON EOL120P	<b>70942</b>	8594056490387	20	38	150	ja   yes		Anschlusswürfel   Terminal block
CYKLON EOL120T	<b>70943</b>	8594056490103	20	38	150		ja   yes	Anschlusswürfel   Terminal block
CYKLON EOL150P	<b>70947</b>	8594056490394	22	38	200	ja   yes		Anschlusswürfel   Terminal block
CYKLON EOL150T	<b>70948</b>	8594056490158	22	38	200		ja   yes	Anschlusswürfel   Terminal block



# Kanlux GRIP

SPLITTER, STECKDOSEN, STECKER ► SPLITTERS, SOCKETS, PLUGS



GRIP GP/S



GRIP W/US

GRIP GP/S	<b>04862</b>	5905339048622	schwarz   black
GRIP W/US	<b>04863</b>	5905339048639	schwarz   black

<b>[V]</b> 250 AC	<b>[Hz]</b> 50		<b>In[A]</b> 16	<b>IP</b> 44			
----------------------	-------------------	--	--------------------	-----------------	--	--	--

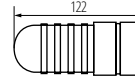

GRIP GP/S

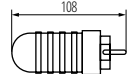

GRIP W/US



# Kanlux PIN W/US

SPLITTER, STECKDOSEN, STECKER ► SPLITTERS, SOCKETS, PLUGS



PIN W/US



PIN W/US	<b>02186</b>	5905339021861	weiß   white
----------	--------------	---------------	--------------

<b>[V]</b> 250 AC	<b>[Hz]</b> 50			<b>In[A]</b> 16	<b>IP</b> 20			
----------------------	-------------------	--	--	--------------------	-----------------	--	--	--

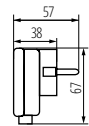

PIN W/US

# Kanlux STAN GP

KUPPLUNG ► STAN GP SPLITTERS, SOCKETS, PLUGS



STAN GP



STAN GP	<b>04864</b>	5905339048646	schwarz   black
---------	--------------	---------------	-----------------

<b>[V]</b> 250 AC	<b>[Hz]</b> 50		<b>In[A]</b> 16	<b>IP</b> 44			
----------------------	-------------------	--	--------------------	-----------------	--	--	--

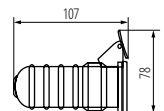

STAN GP

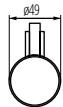

eine Steckdose für Verlängerungskabel  
STAN GP verfügt über die Schutzklasse I gegen elektrischen Schlag  
GRIP GP/S ausgestattet mit Erdung vom Typ Schuko  
Material: Kunststoff  
extension socket for cable cords.  
STAN GP has I Class protection against electric shock  
GRIP GP/S equipped with Schuko earthing  
Material: plastic

Netzstecker für Verlängerungskabel.  
mit Schutzkontakt  
Material: Kunststoff  
extension socket for cable cords.  
Equipped with protective contact  
Material: plastic

Steckbuchse für Verlängerungskabel.  
NICHT FÜR DEN DEUTSCHEN MARKT VERFÜGBAR !!!  
Material: Kunststoff  
extension socket for cable cords.  
Material: plastic

# Kanlux ZARK

SPLITTER, STECKDOSEN, STECKER ▶ SPLITTERS, SOCKETS, PLUGS



ZARK KRT/2-1



ZARK KRT/2-1	<b>02180</b>	5905339021809	weiß   white
ZARK KRW-3	<b>02181</b>	5905339021816	weiß   white

<b>[V]</b> 250 AC	<b>[Hz]</b> 50	<b>[W]</b> 2300			<b>In[A]</b> 16	<b>IP</b> 20			
----------------------	-------------------	--------------------	--	--	--------------------	-----------------	--	--	--

Haben Sie nicht genug Platz, um ein anderes Gerät an die Steckdose anzuschließen? Nichts ist einfacher als Kanlux ZARK Mehrfachstecker um Ihr Problem zu lösen. Dadurch erhalten Sie drei neue Eingänge an der Steckdose. Steckbuchse für Verlängerungskabel.

mit Schutzkontakt  
NICHT FÜR DEN DEUTSCHEN MARKT VERFÜGBAR !!!  
Material: Kunststoff

Don't you have enough room for connecting another device to the socket? Nothing simpler - Kanlux ZARK distributors will solve your problem. Thereby, you will have three new inputs to the socket.

Equipped with protective contact  
Material: plastic

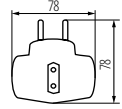

ZARK KRT/2-1

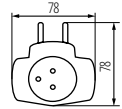

ZARK KRW-3

# Kanlux APO

ZEITSCHALTUHR ▶ CONTROL TIMER / PROGRAMMER



APO TM-3



APO TM-3	<b>07980</b>	5905339079800	1150	5
----------	--------------	---------------	------	---

<b>[V]</b> 220-240 AC	<b>[Hz]</b> 50	<b>In[A]</b> 5	<b>IP</b> 20						
--------------------------	-------------------	-------------------	-----------------	--	--	--	--	--	--

Kanlux APO ist ein Set von 3 Steckdosenadaptern mit Fernbedienung. Jedes angeschlossene Gerät kann unabhängig von den anderen Geräten aktiviert werden. NICHT FÜR DEN DEUTSCHEN MARKT VERFÜGBAR !!!

Im Lieferumfang sind enthalten: 3 Steckdosen, Fernbedienung, Batterie  
NICHT FÜR DEN DEUTSCHEN MARKT VERFÜGBAR !!!  
Bei Impedanzbelastung beträgt die maximale Belastung 1150W  
Die Steckdosen können nebeneinander in einem Abstand von nicht weniger als 0,5 m installiert werden  
Die Diode signalisiert den Betrieb der Steckdose  
Die Reichweite der Fernbedienung beträgt 25 m (bis zu 50 m im Freien)

Kanlux APO is a set of 3 adapters of extension sockets with a possibility of remote control by means of a remote control. Each connected device can be activated independently of others.

In the set: 3 sockets, remote control, battery  
Maximum load with inductive load 1150W  
Sockets can be installed next to one another at a distance of at least 0,5m  
LED indicates that the electrical socket is operational  
Remote control range 25m (up to 50m in the open space)

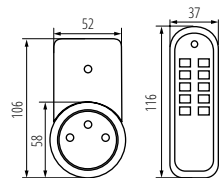

APO TM-3

# Kanlux BR-GZ10

LAMPENFASSUNG ▶ LIGHT SOURCE FITTING



BR-GZ10



BR-GZ10	<b>72369</b>	5905339723697	grau   grey
---------	--------------	---------------	-------------

<b>[V]</b> 250 AC	<b>[Hz]</b> 50	<b>In[A]</b> 2	<b>GU10</b>	<b>IP</b> 00				
----------------------	-------------------	-------------------	-------------	-----------------	--	--	--	--

Die maximal zulässige Temperatur der Fassung für BR-GZ10, HLDR-GZ10, HLDR-R7S beträgt 250°C, für die übrigen Modelle beträgt sie 180°C

Der maximal zulässige Strom für BR-GZ10, HLDR-GZ10, HLDR-G9 beträgt 2A, für HLDR-R7S beträgt er 6A, für HLDR-GX5.3 beträgt er 5A

BR-GZ10 ausgestattet mit einer Stütze

Maximum permissible holder temperature 250°C for BR-GZ10, HLDR-GZ10, HLDR-R7S, for other models - 180°C

Maximum permissible current for BR-GZ10, HLDR-GZ10, HLDR-G9 - 2A, for HLDR-R7S - 6A, for HLDR-GX5.3 - 5A

BR-GZ10 equipped with a support

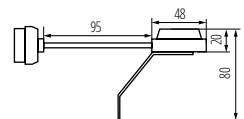

BR-GZ10

**Kanlux**

# HLDR-E14

LAMPENFASSUNG ► LIGHT SOURCE FITTING



HLDR-E14



HLDR-E14 | 02170 | 5905339021700 | grau | grey

<b>[V]</b> 250 AC	<b>[Hz]</b> 50	<b>In[A]</b> 2	<b>E14</b>	<b>IP</b> 00				
----------------------	-------------------	-------------------	------------	-----------------	--	--	--	--

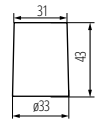

HLDR-E14

Die maximal zulässige Temperatur der Fassung beträgt 180°C  
Maximum permissible holder temperature 180°C

**Kanlux**

# HLDR-E14

LAMPENFASSUNG ► LIGHT SOURCE FITTING



HLDR-E14-F



HLDR-E14-F | 02173 | 5905339021731 | grau | grey

<b>[V]</b> 250 AC	<b>[Hz]</b> 50	<b>In[A]</b> 2	<b>E14</b>	<b>IP</b> 00				
----------------------	-------------------	-------------------	------------	-----------------	--	--	--	--



Die maximal zulässige Temperatur der Fassung beträgt 180°C  
Maximum permissible holder temperature 180°C

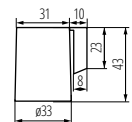

HLDR-E14-F

**Kanlux**

# HLDR-E27

LAMPENFASSUNG ► LIGHT SOURCE FITTING



HLDR-E27



HLDR-E27 | 02160 | 5905339021601 | grau | grey

<b>[V]</b> 250 AC	<b>[Hz]</b> 50	<b>In[A]</b> 4	<b>E27</b>	<b>IP</b> 00				
----------------------	-------------------	-------------------	------------	-----------------	--	--	--	--



Die maximal zulässige Temperatur der Fassung beträgt 180°C  
Maximum permissible holder temperature 180°C

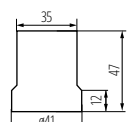

HLDR-E27

**Kanlux**

# HLDL-E27

LAMPENFASSUNG ► LIGHT SOURCE FITTING



HLDL-E27-D



HLDL-E27-D | 02162 | 5905339021625 grau | grey

<b>[V]</b> 250 AC	<b>[Hz]</b> 50	<b>In[A]</b> 4	<b>E27</b>	<b>IP</b> 00				
----------------------	-------------------	-------------------	------------	-----------------	--	--	--	--



Die maximal zulässige Temperatur der Fassung beträgt 180°C  
Maximum permissible holder temperature 180°C

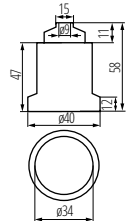

HLDL-E27-D

**Kanlux**

# HLDL-E27

LAMPENFASSUNG ► LIGHT SOURCE FITTING



HLDL-E27-F



HLDL-E27-F | 02161 | 5905339021618 grau | grey

<b>[V]</b> 250 AC	<b>[Hz]</b> 50	<b>In[A]</b> 4	<b>E27</b>	<b>IP</b> 00				
----------------------	-------------------	-------------------	------------	-----------------	--	--	--	--



Die maximal zulässige Temperatur der Fassung beträgt 180°C  
Maximum permissible holder temperature 180°C

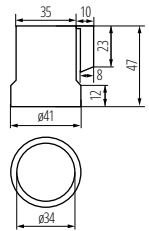

HLDL-E27-F

**Kanlux**

# HLDL-G9

LAMPENFASSUNG ► LIGHT SOURCE FITTING



HLDL-G9



HLDL-G9 | 08220 | 5905339082206 grau | grey

<b>[V]</b> 250 AC	<b>In[A]</b> 2	<b>G9</b>	<b>IP</b> 00				
----------------------	-------------------	-----------	-----------------	--	--	--	--



Die maximal zulässige Temperatur der Fassung für BR-GZ10, HLDL-GZ10, HLDL-R7S beträgt 250°C, für die übrigen Modelle beträgt sie 180°C  
Der maximal zulässige Strom für BR-GZ10, HLDL-GZ10, HLDL-G9 beträgt 2A, für HLDL-R7S beträgt er 6A, für HLDL-GX5.3 beträgt er 5A  
BR-GZ10 ausgestattet mit einer Stütze  
Maximum permissible holder temperature 250°C for BR-GZ10, HLDL-GZ10, HLDL-R7S, for other models – 180°C  
Maximum permissible current for BR-GZ10, HLDL-GZ10, HLDL-G9 – 2A, for HLDL-R7S – 6A, for HLDL-GX5.3 – 5A  
BR-GZ10 equipped with a support

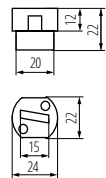

HLDL-G9

**Kanlux**

# HLDR-GX5.3

LAMPENFASSUNG ► LIGHT SOURCE FITTING



HLDR-GX5.3



HLDR-GX5,3 | **72109** | 5905339721099 grau | grey

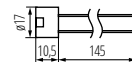

HLDR-GX5.3

Die maximal zulässige Temperatur der Fassung für BR-GZ10, HLDR-GZ10, HLDR-R7S beträgt 250°C, für die übrigen Modelle beträgt sie 180°C

Der maximal zulässige Strom für BR-GZ10, HLDR-GZ10, HLDR-G9 beträgt 2A, für HLDR-R7S beträgt er 6A, für HLDR-GX5.3 beträgt er 5A

BR-GZ10 ausgestattet mit einer Stütze

Maximum permissible holder temperature 250°C for BR-GZ10, HLDR-GZ10, HLDR-R7S, for other models – 180°C

Maximum permissible current for BR-GZ10, HLDR-GZ10, HLDR-G9 – 2A, for HLDR-R7S – 6A, for HLDR-GX5.3 – 5A

BR-GZ10 equipped with a support

**Kanlux**

# HLDR-GZ10

LAMPENFASSUNG ► LIGHT SOURCE FITTING



HLDR-GZ10



HLDR-GZ10 | **00402** | 5905339004024 grau | grey

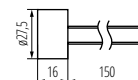

HLDR-GZ10

Die maximal zulässige Temperatur der Fassung für BR-GZ10, HLDR-GZ10, HLDR-R7S beträgt 250°C, für die übrigen Modelle beträgt sie 180°C

Der maximal zulässige Strom für BR-GZ10, HLDR-GZ10, HLDR-G9 beträgt 2A, für HLDR-R7S beträgt er 6A, für HLDR-GX5.3 beträgt er 5A

BR-GZ10 ausgestattet mit einer Stütze

Maximum permissible holder temperature 250°C for BR-GZ10, HLDR-GZ10, HLDR-R7S, for other models – 180°C

Maximum permissible current for BR-GZ10, HLDR-GZ10, HLDR-G9 – 2A, for HLDR-R7S – 6A, for HLDR-GX5.3 – 5A

BR-GZ10 equipped with a support

**Kanlux**

# HLDR-R7S

LAMPENFASSUNG ► LIGHT SOURCE FITTING



HLDR-R7S



HLDR-R7S | **00405** | 5905339004055 grau | grey

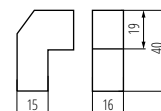

HLDR-R7S

Die maximal zulässige Temperatur der Fassung für BR-GZ10, HLDR-GZ10, HLDR-R7S beträgt 250°C, für die übrigen Modelle beträgt sie 180°C

Der maximal zulässige Strom für BR-GZ10, HLDR-GZ10, HLDR-G9 beträgt 2A, für HLDR-R7S beträgt er 6A, für HLDR-GX5.3 beträgt er 5A

BR-GZ10 ausgestattet mit einer Stütze

Maximum permissible holder temperature 250°C for BR-GZ10, HLDR-GZ10, HLDR-R7S, for other models – 180°C

Maximum permissible current for BR-GZ10, HLDR-GZ10, HLDR-G9 – 2A, for HLDR-R7S – 6A, for HLDR-GX5.3 – 5A

BR-GZ10 equipped with a support





ONTEC S 20M1XATW



MODE

USE



ST AT

				MODE	USE		ST	AT
ONTEC S M1180MSTW	<b>27527</b>	5902052525256	3,3	Not-und Netzschalter   emergency and network	Anti-Panikbeleuchtung   anti-panic lighting	3	✓	
ONTEC S 20M1XSTW	<b>27528</b>	5902052527533	3,6	Notschalter, Not-und Netzschalter   emergency, emergency and network	Anti-Panikbeleuchtung   anti-panic lighting	1\3		✓
ONTEC S 20M1XATW	<b>27529</b>	5902052527489	3,8	Notschalter, Not-und Netzschalter   emergency, emergency and network	Anti-Panikbeleuchtung   anti-panic lighting	1\3		✓
ONTEC S C1302MATW	<b>27652</b>	5902052502523	6,5	Not-und Netzschalter   emergency and network	Beleuchtung des Fluchtweges   lighting of escape routes	3		✓
ONTEC S M1180MATW	<b>28973</b>	5902052521012	3,3	Not-und Netzschalter   emergency and network	Anti-Panikbeleuchtung   anti-panic lighting	3		✓
ONTEC S C1302MATWCLD	<b>28977</b>	5902052529322	6,5	Not-und Netzschalter   emergency and network	Beleuchtung des Fluchtweges   lighting of escape routes	3		✓
ONTEC S C160NMATW	<b>28978</b>	5902052538744	1,2	Notschalter   emergency	Beleuchtung des Fluchtweges   lighting of escape routes	1		✓
ONTEC S W1302MATWCLD	<b>33810</b>	5902052529384	6,5	Not-und Netzschalter   emergency and network	Beleuchtung des Fluchtweges   lighting of escape routes	3		✓
ONTEC S M2302MATWCLD	<b>33818</b>	5902052528745	6,5	Not-und Netzschalter   emergency and network	Anti-Panikbeleuchtung   anti-panic lighting	3		✓
ONTEC S M2102MATWCLD	<b>33819</b>	5902052529261	6,5	Not-und Netzschalter   emergency and network	Anti-Panikbeleuchtung   anti-panic lighting	1		✓
ONTEC S M5105MATW	<b>33840</b>	5902052529575	6,8	Not-und Netzschalter   emergency and network	Anti-Panikbeleuchtung   anti-panic lighting	1		✓
ONTEC S M5305MATW	<b>33841</b>	5902052529582	6,8	Not-und Netzschalter   emergency and network	Anti-Panikbeleuchtung   anti-panic lighting	3		✓
ONTEC S C2105MATW	<b>33842</b>	5902052531950	6,5	Not-und Netzschalter   emergency and network	Beleuchtung des Fluchtweges   lighting of escape routes	3		✓
ONTEC S C2105MATW	<b>33843</b>	5902052529698	6,8	Not-und Netzschalter   emergency and network	Beleuchtung des Fluchtweges   lighting of escape routes	1		✓
ONTEC S F2105MATW	<b>33844</b>	5902052529810	6,8	Not-und Netzschalter   emergency and network	Beleuchtung des Fluchtweges   lighting of escape routes	1		✓
ONTEC S W1302MATW	<b>33845</b>	5902052541454	6,5	Not-und Netzschalter   emergency and network	Beleuchtung von Notausgängen, Feuerlöschgeräten.   lighting of fire exits and firefighting equipment	3		✓
ONTEC S W2105MATWCLD	<b>33846</b>	5902052529445	6,8	Not-und Netzschalter   emergency and network	Beleuchtung von Notausgängen, Feuerlöschgeräten.   lighting of fire exits and firefighting equipment	1		✓
ONTEC S M5105MSTW	<b>33855</b>	5902052529551	6,8	Not-und Netzschalter   emergency and network	Anti-Panikbeleuchtung   anti-panic lighting	1	✓	
ONTEC S M2302MSTWCLD	<b>33856</b>	5902052528738	6,5	Not-und Netzschalter   emergency and network	Anti-Panikbeleuchtung   anti-panic lighting	3		✓
ONTEC S C1302MSTW	<b>33862</b>	5902052531943	6,5	Not-und Netzschalter   emergency and network	Beleuchtung des Fluchtweges   lighting of escape routes	3		✓
ONTEC S F2105MSTW	<b>33864</b>	5902052529797	6,8	Not-und Netzschalter   emergency and network	Beleuchtung des Fluchtweges   lighting of escape routes	1		✓
ONTEC S W1302MSTW	<b>33865</b>	5902052541447	6,5	Not-und Netzschalter   emergency and network	Beleuchtung von Notausgängen, Feuerlöschgeräten.   lighting of fire exits and firefighting equipment	3		✓
ONTEC S W1302MSTWCLD	<b>33866</b>	5902052529377	6,5	Not-und Netzschalter   emergency and network	Beleuchtung von Notausgängen, Feuerlöschgeräten.   lighting of fire exits and firefighting equipment	3		✓
ONTEC S M2302MSTW	<b>36381</b>	5902052528301	6,5	Not-und Netzschalter   emergency and network	Anti-Panikbeleuchtung   anti-panic lighting	3		✓
ONTEC S M2302MATW	<b>36382</b>	5902052528318	6,5	Not-und Netzschalter   emergency and network	Anti-Panikbeleuchtung   anti-panic lighting	3		✓

[V]	[Hz]	IP	TC (K)								
220-240 AC	50	65	5000		SMD		CE	EAC	CNBOP	UK	

# ONTEC S

LED NOTLEUCHTE ► EMERGENCY LIGHTING LED



In öffentlichen Räumen wird Not- oder Panikbeleuchtung eingesetzt, um Panik zu vermeiden. So erreichen Sie die Stelle, an der Sie die Fluchtwegmarkierungen sowie den Fluchtweg selbst erkennen können, je nachdem, welches Prisma in der Leuchte verwendet wird.

Gehäusematerial: Kunststoff  
Abdeckungsmaterial: Kunststoff

Emergency or anti-panic lighting is used in open space rooms to prevent panic. It allows you to reach a place where you can see the marked escape route as well as for the illumination of the escape route itself, depending on the prism used in the fixture.

Enclosure material: plastic  
Lampshade material: plastic



ONTEC S M1180MSTW



ONTEC S 20M1XSTW



ONTEC S 20M1XATW



ONTECSC1302MATW



ONTEC S M1180MATW



ONTEC S C1302MATWCLD



ONTEC S C160NATW



ONTEC S W1302MATWCLD



ONTEC S M2302MATWCLD

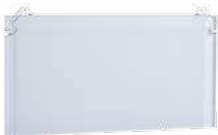

DOPPELSEITIGE BINDUNG OSO

ZUBEHÖR ► ACCESSORIES

OPRAWA DWUSTRONNA OSO	<b>33829</b>	5902052523870
UCHW PODT OS S2 S3 IT	<b>33830</b>	5902052594153
ZEST POD OR00 B	<b>28985</b>	5902052532032
ZEST MONT S20 FLAGA	<b>33876</b>	5902052531899
ZEST MONT OS05	<b>33871</b>	5902052523856
ZEST MONT OS205	<b>33877</b>	5902052552917
ZEST MON OS010 W	<b>28974</b>	5902052546534

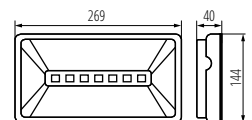

ONTEC S

# Kanlux ITECH

LED NOTLEUCHTE ► EMERGENCY LIGHTING LED



ITECH



UCHW PODT OS S2 S3 IT

Notfall- oder Anti-Panik-Beleuchtung wird verwendet in öffentlichen Raum um Panik zu verhindern. Es ermöglicht Ihnen, einen Ort zu erreichen, an dem Sie den markierten Fluchtweg sehen sowie für die Beleuchtung des Fluchtweges selbst, je nach dem verwendeten Prisma in der Vorrichtung.

Gehäusematerial: Kunststoff

Emergency or anti-panic lighting is used in open space rooms to prevent panic. It allows you to reach a place where you can see the marked escape route as well as for the illumination of the escape route itself, depending on the prism used in the fixture.

Enclosure material: plastic



**MODE**

**USE**



ST

AT

ITECH M1 60 NM ST W	<b>27769</b>	5902052537068	1,2	Notschalter   emergency	Anti-Panikbeleuchtung   anti-panic lighting	1	✓		
ITECH M2 302MATW	<b>33812</b>	5902052530793	6,4	Not-und Netzschalter   emergency and network	Anti-Panikbeleuchtung   anti-panic lighting	3		✓	
ITECH M5 305MATW	<b>33814</b>	5902052531172	6	Not-und Netzschalter   emergency and network	Anti-Panikbeleuchtung   anti-panic lighting	3		✓	
ITECH C1 302MATW	<b>33815</b>	5902052530854	6,4	Not-und Netzschalter   emergency and network	Beleuchtung des Fluchtweges   lighting of escape routes	3			✓
ITECH M2 302MSTW	<b>33821</b>	5902052530786	6,4	Not-und Netzschalter   emergency and network	Anti-Panikbeleuchtung   anti-panic lighting	3	✓		
ITECH M5 105MSTW	<b>33822</b>	5902052531141	6	Not-und Netzschalter   emergency and network	Anti-Panikbeleuchtung   anti-panic lighting	1	✓		
ITECH C1 302STW	<b>33823</b>	5902052530847	6,4	Not-und Netzschalter   emergency and network	Beleuchtung des Fluchtweges   lighting of escape routes	3	✓		
ITECH F2 105MSTW	<b>33824</b>	5902052531028	6	Not-und Netzschalter   emergency and network	Beleuchtung des Fluchtweges   lighting of escape routes	1	✓		
ITECH M5 105MATW	<b>33832</b>	5902052531165	6	Not-und Netzschalter   emergency and network	Anti-Panikbeleuchtung   anti-panic lighting	1		✓	
ITECH S1 302MATW	<b>33833</b>	5902052541010	6,4	Not-und Netzschalter   emergency and network	Anti-Panikbeleuchtung   anti-panic lighting	3		✓	
ITECH C2 105MATW	<b>33834</b>	5902052530922	6	Not-und Netzschalter   emergency and network	Beleuchtung des Fluchtweges   lighting of escape routes	1		✓	
ITECH F1 302MATW	<b>33835</b>	5902052540969	6,4	Not-und Netzschalter   emergency and network	Beleuchtung des Fluchtweges   lighting of escape routes	3		✓	
ITECH F2 105MATW	<b>33836</b>	5902052531042	6	Not-und Netzschalter   emergency and network	Beleuchtung des Fluchtweges   lighting of escape routes	1		✓	
ITECH W2 105MATW	<b>33837</b>	5902052531288	6	Not-und Netzschalter   emergency and network	Beleuchtung von Notausgängen, Feuerlöschgeräten.   lighting of fire exits and firefighting equipment	1		✓	
ITECH M1 60 NM MATW	<b>33872</b>	5902052537051	1,2	Notschalter   emergency	Anti-Panikbeleuchtung   anti-panic lighting	1			✓

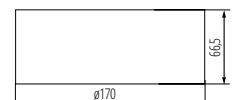

ZUBEHÖR ► ACCESSORIES

UCHW PODT OS S2 S3 IT | **33830** | 5902052594153

# Kanlux ONTEC G

LED NOTLEUCHTE ► EMERGENCY LIGHTING LED



ONTEC G

In öffentlichen Räumen wird Not- oder Panikbeleuchtung eingesetzt, um Panik zu vermeiden. So erreichen Sie die Stelle, an der Sie die Fluchtwegmarkierungen sowie den Fluchtweg selbst erkennen können, je nachdem, welches Prisma in der Leuchte verwendet wird.

Gehäusematerial: Kunststoff  
Abdeckungsmaterial: Kunststoff

Emergency or anti-panic lighting is used in open space rooms to prevent panic. It allows you to reach a place where you can see the marked escape route as well as for the illumination of the escape route itself, depending on the prism used in the fixture.

Enclosure material: plastic  
Lampshade material: plastic

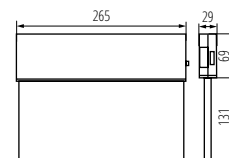

ONTEC G

			(W)	MODE	USE	(h)	ST	AT
ONTEC G E1E301 M STW	<b>28976</b>	5902052538638	4,8	Not-und Netzschalter   emergency and network	Bestimmen der Evakuierungsrichtung   marking of escape routes	3	✓	
ONTEC G E1E180MATW	<b>28979</b>	5902052563340	3	Not-und Netzschalter   emergency and network	Bestimmen der Evakuierungsrichtung   marking of escape routes	3		✓

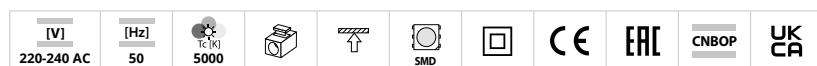

# Kanlux ONTEC C

LED NOTLEUCHTE ► EMERGENCY LIGHTING LED



ONTEC C M160NMATW

In öffentlichen Räumen wird Not- oder Panikbeleuchtung eingesetzt, um Panik zu vermeiden. So erreichen Sie die Stelle, an der Sie die Fluchtwegmarkierungen sowie den Fluchtweg selbst erkennen können, je nachdem, welches Prisma in der Leuchte verwendet wird.

Gehäusematerial: Kunststoff  
Abdeckungsmaterial: Kunststoff

Emergency or anti-panic lighting is used in open space rooms to prevent panic. It allows you to reach a place where you can see the marked escape route as well as for the illumination of the escape route itself, depending on the prism used in the fixture.

Enclosure material: plastic  
Lampshade material: plastic

			(W)	MODE	USE	(h)	ST	AT
ONTEC C M160NMATW	<b>33847</b>	5902052536269	1,2	Notschalter   emergency	Anti-Panikbeleuchtung   anti-panic lighting	1		✓
ONTEC C M2302MATW	<b>33848</b>	5902052528806	7	Not-und Netzschalter   emergency and network	Beleuchtung des Fluchtweges   lighting of escape routes	3		✓
ONTEC C C160NMATW	<b>33849</b>	5902052536504	1,2	Notschalter   emergency	Beleuchtung des Fluchtweges   lighting of escape routes	1		✓
ONTEC C M160NMSTW	<b>33858</b>	5902052536207	1,2	Notschalter   emergency	Anti-Panikbeleuchtung   anti-panic lighting	1	✓	
ONTEC C C160NMSTW	<b>33868</b>	5902052536443	1,2	Notschalter   emergency	Beleuchtung des Fluchtweges   lighting of escape routes	1	✓	

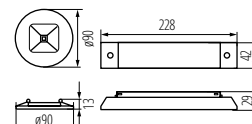

ONTEC C



# ONTEC R

LED NOTLEUCHTE ► EMERGENCY LIGHTING LED



ONTEC R C



ONTEC R M



ZESTAW MONT. P/T ONTEC R

In öffentlichen Räumen wird Not- oder Panikbeleuchtung eingesetzt, um Panik zu vermeiden. So erreichen Sie die Stelle, an der Sie die Fluchtwegmarkierungen sowie den Fluchtweg selbst erkennen können, je nachdem, welches Prisma in der Leuchte verwendet wird.

Gehäusematerial: Kunststoff  
Abdeckungsmaterial: Kunststoff

Emergency or anti-panic lighting is used in open space rooms to prevent panic. It allows you to reach a place where you can see the marked escape route as well as for the illumination of the escape route itself, depending on the prism used in the fixture.

Enclosure material: plastic  
Lampshade material: plastic



MODE

USE



ST AT

ONTEC R M1 60N M STW	<b>29098</b>	5902052535736	1,2	Notschalter   emergency	Anti-Panikbeleuchtung   anti-panic lighting	1	✓	
ONTEC R C1 60N M STW	<b>33826</b>	5902052535965	1,2	Notschalter   emergency	Beleuchtung des Fluchtweges   lighting of escape routes	1	✓	
ONTEC R C1 302 M STW	<b>33827</b>	5902052529179	7,2	Not-und Netzschalter   emergency and network	Beleuchtung des Fluchtweges   lighting of escape routes	3	✓	
ONTEC R M1 60N M ATW	<b>33850</b>	5902052535781	1,2	Notschalter   emergency	Anti-Panikbeleuchtung   anti-panic lighting	1		✓
ONTEC R M2 302 M ATW	<b>33851</b>	5902052529124	7,2	Not-und Netzschalter   emergency and network	Anti-Panikbeleuchtung   anti-panic lighting	3		✓
ONTEC R C1 60N M ATW	<b>33852</b>	5902052536023	1,2	Notschalter   emergency	Beleuchtung des Fluchtweges   lighting of escape routes	1		✓
ONTEC R M5 105 M STW	<b>33860</b>	5902052520732	6,7	Not-und Netzschalter   emergency and network	Anti-Panikbeleuchtung   anti-panic lighting	1	✓	
ONTEC R M5 105 M ATW	<b>33870</b>	5902052520787	6,7	Not-und Netzschalter   emergency and network	Anti-Panikbeleuchtung   anti-panic lighting	1		✓

[VI] 220-240 AC  
 [Hz] 50  
 IP 20  
 TC 5000  
 SMD  
 CE  
 EAC  
 CNBOP  
 UK CA

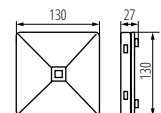

ZUBEHÖR ► ACCESSORIES

ZEST PODT OR00 W | **33831** | 5902052532025

ONTEC R

# PICTO G

EVAKUIERUNGSPIKTOGRAMM ► EXIT SIGN



PICTO ONTEC G D5

PICTO ONTEC G D5	27482	5905339274823
PICTO ONTEC G D2	27483	5905339274830
PICTO ONTEC G D3	27484	5905339274847
PICTO ONTEC G D8	27485	5905339274854
PICTO ONTEC G D7	27488	5905339274885
PICTO ONTEC G W1	27490	5905339274908
PICTO ONTEC G F1	27497	5905339274977
PICTO ONTEC G F2	27498	5905339274984
PICTO ONTEC G DB	27499	5905339274991
PICTO ONTEC G DC	27500	5905339275004



PICTO ONTEC G D5



PICTO ONTEC G D2



PICTO ONTEC G D3



PICTO ONTEC G D8



PICTO ONTEC G D7



PICTO ONTEC G W1



PICTO ONTEC G F1



PICTO ONTEC G F2



PICTO ONTEC G DB



PICTO ONTEC G DC

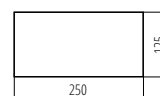

PICTO ONTEC G



PICTO ONTEC S D5

PICTO ONTEC S D5	<b>27505</b>	5905339275059
PICTO ONTEC S D2	<b>27506</b>	5905339275066
PICTO ONTEC S D3	<b>27507</b>	5905339275073
PICTO ONTEC S D8	<b>27508</b>	5905339275080
PICTO ONTEC S D1	<b>27509</b>	5905339275097
PICTO ONTEC S D6	<b>27510</b>	5905339275103
PICTO ONTEC S D7	<b>27511</b>	5905339275110
PICTO ONTEC S D4	<b>27512</b>	5905339275127
PICTO ONTEC S W1	<b>27513</b>	5905339275134
PICTO ONTEC S W2	<b>27514</b>	5905339275141
PICTO ONTEC S F1	<b>27520</b>	5905339275202
PICTO ONTEC S DB	<b>27522</b>	5905339275226
PICTO ONTEC S DC	<b>27523</b>	5905339275233



PICTO ONTEC S D5



PICTO ONTEC S D2



PICTO ONTEC S D3



PICTO ONTEC S D8



PICTO ONTEC S D1



PICTO ONTEC S D6



PICTO ONTEC S D7



PICTO ONTEC S D4



PICTO ONTEC S W1



PICTO ONTEC S W2



PICTO ONTEC S F1



PICTO ONTEC S DB



PICTO ONTEC S DC

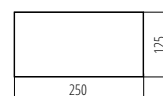

PICTO ONTEC S

**Kanlux**

**IT**

ISOLIERBAND ► SELF-ADHESIVE INSULATION TAPE

IT-1/20- MIX: eine Einzelverpackung beinhaltet 10 Stück  
IT-1: nur in Sammelverpackung erhältlich (10 Stück)  
IT-1/20- MIX: unit package containing 10 pcs.  
IT-1: offered only in sub-packaging (10 pcs.)



IT-1/10-B

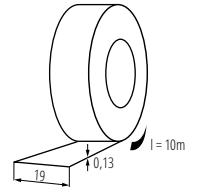

IT-1/10

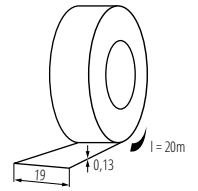

IT-1/20



IT-1/10-B	<b>01257</b>	5905339012579	schwarz   black
IT-1/20-B	<b>01271</b>	5905339012715	schwarz   black
IT-1/20-Y	<b>01272</b>	5905339012722	gelb   yellow
IT-1/20-RE	<b>01273</b>	5905339012739	rot   red
IT-1/20-GN	<b>01274</b>	5905339012746	grün   green
IT-1/20-BL	<b>01275</b>	5905339012753	blau   blue
IT-1/20-W	<b>01276</b>	5905339012760	weiß   white
IT-1/20-Y/GN	<b>01277</b>	5905339012777	gelb/grün   yellow / green
IT-1/20-MIX	<b>01283</b>	5905339012838	mehrfarbig   multicoloured





## VERWENDETE SYMBOLE USED SYMBOLS

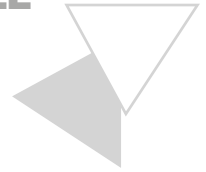

### IP Erklärungen der Stufe der Resistenz gegen das Eindringen von festen Fremdkörpern, Staub und Feuchtigkeit Explanation of degree of resistance to penetration of foreign solids, dust and humidity

Grad des Schutzes vor versehentlichem Kontakt mit den Teilen, die unter Spannung stehen  
Degree of protection against inadvertent contact with the live parts

IP	Zeichnung / Picture	Beschreibung / Description	Erklärung / Explanation
0		Kein Schutz No protection	Keine speziellen Schutzmaßnahmen No special protection means
1		Schutz vor festen Fremdkörpern mit der Größe von mehr als 50 mm Protection against solids bigger than 50mm	Eine große Oberfläche des menschlichen Körpers, die etwa der Handoberfläche entspricht (kein Schutz vor der Berührung). Feste Fremdkörper mit der Größe von mehr als 50mm Large parts of a human body, equal to e.g. the area of a palm (no protection against touching). Solids with the diameter above 50mm
2		Schutz vor festen Fremdkörpern, deren Größe 12mm überschreitet Protection against solids bigger than 12mm	Ein Finger oder ähnliche Gegenstände mit einer Länge, die nicht 80mm überschreitet. Feste Fremdkörper mit einem Durchmesser, der nicht 12mm überschreitet A finger or similar objects not longer than 80mm. Solids with the diameter above 12mm
3		Schutz vor festen Fremdkörpern, deren Größe 2,5mm überschreitet Protection against solids bigger than 2,5mm	Werkzeuge, Draht, u.ä. mit einem Durchmesser oder einer Dicke, die 2,5mm überschreitet. Feste Fremdkörper mit einem Durchmesser von mehr als 2,5mm Tools, a wire etc. with the diameter or the wire gauge exceeding 2,5mm. Solids with the diameter above 2,5mm
4		Schutz vor festen Fremdkörpern, deren Größe 1mm überschreitet Protection against solids bigger than 1mm	Draht oder Band von einer Dicke von 1mm. Feste Fremdkörper mit einem Durchmesser, der 1mm überschreitet A wire or a strip 1mm thick. Solids with the diameter above 1mm
5		Staubresistenz Dust resistance	Eine kleine Menge Staub dringt in das Innere des Gehäuses ein, aber sie ist so gering, dass sie keinen negativen Einfluss auf den Betrieb des Geräts hat. Small amount of dust penetrates the shield interior but it is so small that it does not exert a negative influence on the equipment operation
6		Staubdichtheit Dust-proofing	Staub dringt nicht ins Innere des Gehäuses ein Dust does not penetrate the shield interior

Grad des Schutzes vor Feuchtigkeit  
Degree of protection against moisture

IP	Zeichnung / Picture	Beschreibung / Description	Erklärung / Explanation
0		Kein Schutz No protection	Keine speziellen Schutzmaßnahmen No special protection measures
1		Keine speziellen Schutzmaßnahmen Protection against vertically falling water drops	Die senkrecht fallenden Wassertropfen können keine schädlichen Folgen im Gerät auslösen Vertically falling water drops cannot cause detrimental effects within the equipment
2		Schutz vor schräg fallendem Tropfenwasser bis 15° Protection against water drops at up to 15-degree angle of deflection	Die senkrecht fallenden Wassertropfen können bei einer Schräglage des Gehäuses bis zu 15° ausgehend von der Normallage keine schädlichen Folgen im Gerät auslösen Vertically falling water drops cannot cause detrimental effects within the equipment when the shield is tilted up to 15 degrees from its normal position
3		Schutz vor Sprühwasser Protection against sprayed water	Das Sprühwasser, das unter einem Winkel von 60° ausgehend von der Senkrechten fällt, sollte keine schädlichen Effekte auslösen Sprayed water falling at a 60-degree angle of deflection from the vertical should not cause detrimental effects
4		Schutz vor Strahlwasser Protection against water splashes	Wasser, das aus allen Richtungen auf die Abschirmung gespritzt wird, sollte keine nachteiligen Auswirkungen haben. Water splashed onto the shield from any direction should not cause detrimental effects
5		Schutz vor Strahlwasser Protection against water streams	Das auf das Gehäuse aus beliebiger Richtung aus der Düse gerichtete Wasser sollte keine schädlichen Folgen auslösen Water from a nozzle directed onto the casing from any direction should not cause detrimental effects
6		Schutz vor Wasserwellen Protection against waves	Die Wasserwelle bei einer Überschwemmung oder ein starker Wasserstrahl kann nicht in das Innere des Gehäuses in solcher Menge gelangen, dass es schädliche Folgen auslöst A flooding water wave or a strong stream cannot penetrate the shield in the amount causing detrimental effects
7		Schutz vor dem Eintauchen Protection against immersion	Beim zeitweiligen Eintauchen des Gerätes ins Wasser und bei bestimmtem Druck kann das Wasser nicht in das Innere des Gehäuses in solcher Menge gelangen, dass es schädliche Folgen auslöst When the equipment is immersed in water for the predetermined time and at the predetermined pressure, water cannot penetrate the shield in the amount causing detrimental effects
8		Schutz vor tiefem Eintauchen Protection against deep immersion	Das Gerät ist ein langfristiges Eintauchen in das Wasser unter den durch den Hersteller bestimmten Bedingungen angepasst The equipment adapted to long-lasting immersion in water in the conditions specified by the manufacturer

# VERWENDETE SYMBOLE USED SYMBOLS



Schutzklasse Safety class	Symbol Symbol	Erklärung Explanation
<b>0</b>	Keine None	Der Schutz gegen Stromschlag bildet die Basisisolierung. Im Falle einer Beschädigung der Isolierung sollten für den Brandschutz die entsprechenden günstigen Bedingungen in der Umgebung und die Lage des Gerätes außerhalb direkter Berührung sorgen. Protection against electrical shock is guaranteed by the basic isolation. In case that the isolation is damaged, the anti-shock protection should be guaranteed by the appropriately favourable environmental conditions and the equipment location beyond the direct touch
<b>I</b>		In den Geräten mit der I. Schutzklasse sollte die Sicherheit durch die Verbindung aller aktiven Leitungselemente mit dem Schutzkabel oder direkt mit der Erdung gewährleistet sein In the equipment of the I class protection the safety is guaranteed through connection of all active conducting elements with a protective conductor or directly with the grounding
<b>II</b>		In den Geräten mit der II. Schutzklasse sollte die Sicherheit durch die Anwendung einer doppelten oder verstärkten Isolierung gewährleistet sein, die unter gegebenen Bedingungen der Umgebung und bei Nennspannung als durchschlagfest betrachtet wird In the equipment of the II class protection the safety is guaranteed through the application of double or reinforced isolation, which in the given environmental conditions and at the rated voltage is considered unbreakable
<b>III</b>		Der Schutz gegen Stromschlag wird in den Geräten mit der III. Schutzklasse durch die Senkung der Versorgungsspannung bis zu einem unter gegebenen Umgebungsbedingungen sicheren Wert gewährleistet The anti-shock protection in the III class equipment is guaranteed through decreasing of the supply voltage to the value which is safe in the given environmental conditions

Die Farbtemperatur  $T_c$  [K] ist die Temperatur eines idealen schwarzen Körpers, in der es die Lichtstrahlung von derselben Farbe wie die betrachtete Quelle aussendet. Es ist also das objektive Maß für den Farbeindruck von der gegebenen Lichtquelle  
Colour temperature  $T_c$  [K] is the temperature of a perfect radiator at which it sends visible radiation of the same colour as the colour of the examined source. This is hence an objective measure of the colour impression of the given source of light

<2700K	Gelbweiße Farbe	Yellow-white colour
2700-3300K	Warmweiße Farbe	Warm white colour
3300-5300K	Neutrale Farbe (weiß)	Neutral colour (white)
>5300K	Tageslichtfarbe (kaltes Weiß)	Daylight colour (cool white)

# VERWENDETE SYMBOLE USED SYMBOLS

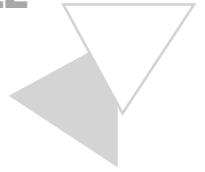

<b>27395</b>	Code Kanlux / Kanlux code
5902052559695	Code EAN / EAN code
	Farbe / colour
	Nennspannung / rated voltage
	einseitige Versorgung der Leuchtstoffröhren T8 LED / the range of humidity to which the product is adapted
	Leistung / power
	Nennfrequenz / rated frequency
	Eingangsspannung / input voltage
	Ausgangsspannung / output voltage
	Ausgangsstrom / output current
	Nennstrom / rated current
	jährlicher Energieverbrauch / annual energy consumption
	Anzahl der Zyklen Ein / Aus / number on/of switch cycles
	Äquivalenzklärung zur Leistung / declaration of equivalence regarding power
	nicht austauschbare Lichtquelle / non-replaceable light source
	austauschbare Lichtquelle / replaceable light source
	Farbtemperatur (Tc) / colour temperature (Tc)
	Lichtfarbe / colour temperature
	Lichtausbeute / luminous efficiency
	Gleichmäßigkeit der Farben [SDCM] / color uniformity [SDCM]

	ellipse ≤ 6x MacAdam; ellipse ≤ 3x MacAdam
	Lichtstrom / luminous flux
	Nomineller Nutzlichtstrom / nominal useful luminous flux
	Farbwiedergabeindex Ra / color rendering index Ra
	Umgebungstemperaturbereich, in dem das Produkt angepasst ist / ambient temperature range to which the product is adapted
	Der Bereich der Luftfeuchtigkeit an den das Produkt angepasst ist / the range of humidity to which the product is adapted
	Abstrahlwinkel / light beam angle
	Lebensdauer / durability
	Energieeffizienzklasse (Ei) / energy efficiency class (Ei)
	nicht in Kreisläufen mit elektronischen Geräten (z.B.: mit dem Dimmer) verwenden / do not use in circuits with electronic devices (e.g. dimmer)
	Möglichkeit einer Zusammenarbeit mit dem Dimmer / the possibility of cooperation with a dimmer
	Möglichkeit einer Zusammenarbeit mit dem Dimmer 1-10V / possibility of cooperation with 1-10V dimmer
	Möglichkeit einer Zusammenarbeit mit dem Dimmer DALI / possibility of cooperation with DALI dimmer
	Mit Schalter ausgestattet / equipped with a switch
	Mit Hygrometer ausgestattet / equipped with a hygrometer
	Mit Timer-Funktion ausgestattet / equipped with a timer
	Mit Zugschalter ausgestattet / equipped with a pull switch
	Kein Quecksilber / no mercury
	Quecksilber-Gehalt / mercury content
	Minimale Entfernung von dem beleuchteten Objekt / the minimum distance from the illuminated object
	Leistungskoeffizient / power factor
	Länge / length

	UGR / UGR
	horizontal bewegliche Fassung / horizontally movable fitting
	vertikal bewegliche Fassung / vertically movable fitting
	feste Fassung / stationary fitting
	Winkelregulierung der Leuchtfassung [°] / angle adjustment of the lighting fixture [°]
	Winkelregulierung der Leuchtfassung in zwei Achsen / angle adjustment of the lighting fixture in two axes
	Winkelregulierung der Leuchtfassung in einer Achse / angle adjustment of the lighting fixture in one axis
	Montageöffnung / mounting hole
	Art des Vorschaltgerätes: elektronisch / ballast type: electronic
	Art des Vorschaltgerätes: induktiv / ballast type: inductive
	Art der Energieversorgung - Dauerspannung / type of power supply - constant voltage
	Art der Energieversorgung - Dauerstrom / type of power supply - constant current
	Stufe der Resistenz gegen das Eindringen von festen Fremdkörpern und Feuchtigkeit (IP) / solids and humidity penetration protection degree (IP)
	Stufe des Schutzes vor mechanischer Schlagbeanspruchung / degree of protection against mechanical impacts
	zur Anwendung im Innenbereich / for indoor use
	zur Anwendung im Innenbereich oder im Außenbereich / for indoor or outdoor use
	Übereinstimmung mit europäischen Normen (CE) / compliance with European standards (CE)
	Konformitätszertifikat, das die Qualität der Produktion mit den in der Zollunion festgelegten Standards bestätigt / certificate of Conformity confirming the quality of production in accordance with approved standards on the territory of the Customs Union
	das Produkt entspricht den in der Ukraine geltenden Vorschriften / the product is compliant with all relevant Ukraine regulations
	Das Produkt entspricht den im Großbritannien (UK) geltenden Vorschriften. / the product is compliant with all relevant United Kingdom regulations
	Schutzklasse gegen elektrischen Schlag I. / class of protection against electric shock I

# VERWENDETE SYMBOLE USED SYMBOLS



	Schutzklasse gegen elektrischen Schlag II. / class of protection against electric shock II
	Schutzklasse gegen elektrischen Schlag II/III. / class of protection against electric shock II/III
	Schutzklasse gegen elektrischen Schlag III. / class of protection against electric shock III
	Die Lampe ist nicht für eine Akzentbeleuchtung geeignet / the lamp is not designed for accent lighting
	Die Lampe ist für eine Akzentbeleuchtung geeignet / the lamp is designed for accent lighting
	Möglichkeit der Montage an normal entflammaren Oberflächen / can be mounted on normally flammable surfaces
	Leuchtmittel im Set enthalten / light source included
	Senderbatterien / Transmitter batteries
	Steuerung: RF 2,4 GHz / control: RF 2,4 GHz
	Kabel mit Steckverbinder - DC / cable terminated with a plug - DC

Leuchtmitteltyp / light source type

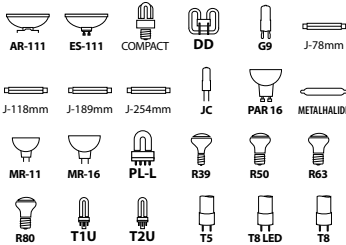

Sockel / cap

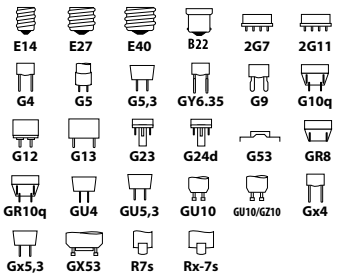

Diodeart / LED type



	Leuchtrichtung / lighting direction
	Schraubklemme / screw cube
	Anschlussblock / connection block
	Steckklemme / self-locking cube
	Kabel mit Stecker / cable with a plug
	Kabel mit freien Ende / free cable ends
	Kabeldurchmesser / wire diameter
	Kabellänge / cable length
	Durchmesserbereich der angewendeten Kabel / range of cross-sections of cables used
	Die Länge des Netzkabels mit dem Stecker / length of the power cord terminated with a plug

Montage / assembly

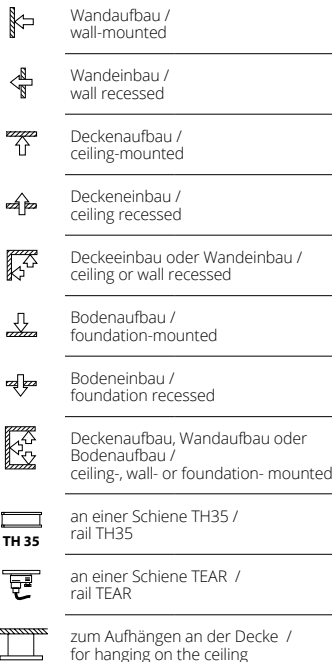

	PIR
	micro wave
	2 x PIR
	3 x PIR
	Charakteristik des Auslösens / trigger characteristics
	Betriebszeit des Sensors / sensor operation time
	Betriebswinkel des Sensors / sensor operating angle
	Reichweite des Sensors / sensor range
	Einstellung der Beleuchtungsstufe, bei der der Sensor die Bewegung erkennt / setting the brightness level at which the sensor detects movement
	Lautstärke / loudness
	Luftdurchfluss-Volumen [m <sup>3</sup> /h] / the volumetric air flow [m <sup>3</sup> /h]
	Motorumdrehungen / engine speed
	Anzahl der Pole / number of poles
	Anzahl der Module / number of modules
	Anwendung / application
	Betriebsart / operating mode
	Standardtest / standard test
	automatischer Test / automatic test
	Notbetriebszeit / emergency operation time

ABETE LED 60 GR	36570	<b>285</b>	ALIN LED LINE	xxx	<b>18</b>
ABETE LED 80 GR	36571	<b>285</b>	ALOR DSL-B	26727	<b>169</b>
ABETE LED EL 20 GR	36572	<b>285</b>	ALOR DSL-W	26726	<b>169</b>
ABETE LED EL 20 SE-GR	36573	<b>285</b>	ALOR DSO-B	26791	<b>169</b>
ADI 350 1x3W	1440	<b>335</b>	ALOR DSO-W	26790	<b>169</b>
ADTR	xxx	<b>30</b>	ALOR DTL-B	26732	<b>169</b>
ADTR 12030 B	27614	<b>213</b>	ALOR DTL-W	26731	<b>169</b>
ADTR 12030 B	27614	<b>209</b>	ALOR DTO-B	26796	<b>169</b>
ADTR 12030 SR	27612	<b>213</b>	ALOR DTO-W	26795	<b>169</b>
ADTR 12030 SR	27612	<b>209</b>	ALREN DTL-B	26754	<b>176</b>
ADTR 12030 W	27611	<b>213</b>	ALREN DTL-C/M	26756	<b>176</b>
ADTR 12030 W	27611	<b>209</b>	ALREN DTL-W	26753	<b>176</b>
ADTR 3060 B	29842	<b>213</b>	ALREN R DTL-B	26757	<b>176</b>
ADTR 3060 SR	29841	<b>213</b>	ALREN R DTL-W	26758	<b>176</b>
ADTR 3060 W	29840	<b>213</b>	AMAZI LED 17,5W NW B	37325	<b>116</b>
ADTR 6060 B	27615	<b>213</b>	ANTEM LED 100W-NW B	33204	<b>266</b>
ADTR 6060 B	27615	<b>209</b>	ANTEM LED 10W-NW B	33200	<b>266</b>
ADTR 6060 SR	27610	<b>213</b>	ANTEM LED 10W-NW-SE B	33205	<b>266</b>
ADTR 6060 SR	27610	<b>209</b>	ANTEM LED 20W-NW B	33201	<b>266</b>
ADTR 6060 W	27613	<b>213</b>	ANTEM LED 20W-NW-SE B	33206	<b>266</b>
ADTR 6060 W	27613	<b>209</b>	ANTEM LED 30W-NW B	33202	<b>266</b>
ADTR-H 12030 B	33391	<b>209</b>	ANTEM LED 30W-NW-SE B	33207	<b>266</b>
ADTR-H 12030 SR	33392	<b>209</b>	ANTEM LED 50W-NW B	33203	<b>266</b>
ADTR-H 12030 W	33390	<b>209</b>	ANTEM LED 50W-NW-SE B	33208	<b>266</b>
ADTR-H 12030 W	33390	<b>211</b>	APO TM -3	7980	<b>340</b>
ADTR-H 3060 W	33393	<b>211</b>	APRILA DTO-W	26738	<b>165</b>
ADTR-H 6060 B	29845	<b>209</b>	APUS LED AC B-NW	26536	<b>196</b>
ADTR-H 6060 SR	29844	<b>209</b>	APUS LED AC B-WW	26537	<b>196</b>
ADTR-H 6060 W	29843	<b>209</b>	APUS LED AC-CW	23801	<b>196</b>
ADTR-H 6060 W	29843	<b>211</b>	APUS LED AC-WW	23800	<b>196</b>
ADTR-H 6262 W	33435	<b>209</b>	APUS LED B-NW	26538	<b>196</b>
ADTR-H 76MM 6060 W	33398	<b>209</b>	APUS LED B-WW	26539	<b>196</b>
ADTR-S 6060 W	27616	<b>209</b>	APUS LED CW	23107	<b>196</b>
ADTR-S-H 6060 W	27617	<b>209</b>	APUS LED NW	32488	<b>196</b>
AGEO DSO-B	33165	<b>165</b>	APUS LED PIR B-NW	29856	<b>196</b>
AGEO DSO-W	33166	<b>165</b>	APUS LED PIR B-WW	29857	<b>196</b>
AGZAR C 3xE14 B	36252	<b>104</b>	APUS LED PIR NW	27379	<b>196</b>
AGZAR C 3xE14 W	36253	<b>104</b>	APUS LED PIR WW	27370	<b>196</b>
AGZAR E14 B	36250	<b>144</b>	APUS LED W-CW	26841	<b>196</b>
AGZAR E14 W	36251	<b>144</b>	APUS LED W-NW	27378	<b>196</b>
AGZAR EL-10 B	36254	<b>144</b>	APUS LED W-W	23106	<b>196</b>
AGZAR EL-10 W	36255	<b>144</b>	APUS LED W-WW	26840	<b>196</b>
AKVEN LED	25720	<b>300</b>	AQILO E14 IP65 DSO-B	36642	<b>108</b>
AKVO IP44 15W-NW-B	36660	<b>193</b>	AQILO E14 IP65 DSO-GR	36640	<b>108</b>
AKVO IP44 15W-NW-B S	36651	<b>192</b>	AQILO E14 IP65 DSO-W	36641	<b>108</b>
AKVO IP44 15W-NW-C	36661	<b>193</b>	AQILO E27 IP65 DSO-B	36645	<b>108</b>
AKVO IP44 15W-NW-C S	36652	<b>192</b>	AQILO E27 IP65 DSO-GR	36643	<b>108</b>
AKVO IP44 15W-NW-W	36659	<b>193</b>	AQILO E27 IP65 DSO-W	36644	<b>108</b>
AKVO IP44 15W-NW-W S	36650	<b>192</b>	AQILO IP65 DSO-B	33361	<b>108</b>
AKVO IP44 20W-NW-B	36663	<b>193</b>	AQILO IP65 DSO-GR	33362	<b>108</b>
AKVO IP44 20W-NW-B S	36654	<b>192</b>	AQILO IP65 DSO-W	33360	<b>108</b>
AKVO IP44 20W-NW-C	36664	<b>193</b>	AREL FRAME DO 14W W	33651	<b>252</b>
AKVO IP44 20W-NW-C S	36655	<b>192</b>	AREL LED DL 10W-NW	29586	<b>252</b>
AKVO IP44 20W-NW-W	36662	<b>193</b>	AREL LED DL 14W-NW	29590	<b>252</b>
AKVO IP44 20W-NW-W S	36653	<b>192</b>	AREL LED DL 6W-NW	29582	<b>252</b>
AKVO IP44 23W-NW-B	36666	<b>193</b>	AREL LED DO 10W-NW	29584	<b>252</b>
AKVO IP44 23W-NW-B S	36657	<b>192</b>	AREL LED DO 10W-WW	29585	<b>252</b>
AKVO IP44 23W-NW-C	36667	<b>193</b>	AREL LED DO 14W-NW	29588	<b>252</b>
AKVO IP44 23W-NW-C S	36658	<b>192</b>	AREL LED DO 14W-WW	29589	<b>252</b>
AKVO IP44 23W-NW-W	36665	<b>193</b>	AREL LED DO 6W-NW	29580	<b>252</b>
AKVO IP44 23W-NW-W S	36656	<b>192</b>	AREL LED DO 6W-WW	29581	<b>252</b>
ALDO 4LED 1X120	26361	<b>228</b>	ARET 1XMR16-W	26720	<b>175</b>
ALDO 4LED 1X150	26362	<b>228</b>	ARET 2XMR16-W	26723	<b>175</b>
ALDO 4LED 1X60	26360	<b>228</b>	ARGUS II CT-2114-AN	37150	<b>182</b>
ALDO 4LED 2X120	26364	<b>228</b>	ARGUS II CT-2114-BR/M	37151	<b>182</b>
ALDO 4LED 2X150	26365	<b>228</b>	ARGUS II CT-2114-C	37152	<b>182</b>
ALER JQ-30-B	461	<b>326</b>	ARGUS II CT-2114-C/M	37153	<b>182</b>
ALER JQ-30-W	460	<b>326</b>	ARGUS II CT-2114-G	37154	<b>182</b>
ALER MINI-W	23450	<b>326</b>	ARGUS II CT-2114-GM	37155	<b>182</b>
ALER N-B	37363	<b>322</b>	ARGUS II CT-2114-W	37156	<b>182</b>
ALER N-W	37362	<b>322</b>	ARGUS II CT-2115-AN	37157	<b>182</b>
ALIN 4LED	xxx	<b>20</b>	ARGUS II CT-2115-BR/M	37158	<b>182</b>
ALIN 4LED LINE	xxx	<b>22</b>	ARGUS II CT-2115-C	37159	<b>182</b>
ALIN LED	xxx	<b>16</b>	ARGUS II CT-2115-C/M	37160	<b>182</b>

ARGUS II CT-2115-G	37161	<b>182</b>	BLINGO 34W 4080 60CW	37172	<b>208</b>
ARGUS II CT-2115-GM	37162	<b>182</b>	BLINGO 34W 4080 60NW	37171	<b>208</b>
ARGUS II CT-2115-W	37163	<b>182</b>	BLINGO 38W 4560 120NW	37177	<b>208</b>
ARVOS LED 37W CCT B	37330	<b>120</b>	BLINGO 38W 4560 60NW	37176	<b>208</b>
ARVOS LED 37W CCT W	37331	<b>120</b>	BLINGO DALI SET 38W	28515	<b>211</b>
ASTEN IP44 12W-NW-B	26684	<b>190</b>	BLINGO DALI SET 38W	28515	<b>211</b>
ASTEN IP44 12W-NW-W	26687	<b>190</b>	BLINGO DRV 24W ON-OFF	37272	<b>211</b>
ASTEN IP44 15W-NW-B	26685	<b>190</b>	BLINGO DRV 24W ON-OFF	37272	<b>211</b>
ASTEN IP44 15W-NW-W	26688	<b>190</b>	BLINGO DRV 32W ON-OFF	37269	<b>211</b>
ASTEN IP44 8W-NW-B	26683	<b>190</b>	BLINGO DRV 32W ON-OFF	37269	<b>211</b>
ASTEN IP44 8W-NW-W	26686	<b>190</b>	BLINGO DRV 40W ON-OFF	37270	<b>211</b>
ASTEN LED IP44 12W-NW	26681	<b>190</b>	BLINGO DRV 40W ON-OFF	37270	<b>211</b>
ASTEN LED IP44 15W-NW	26682	<b>190</b>	BLINGO DRV40W1-10V BK	37268	<b>211</b>
ASTEN LED IP44 8W-NW	26680	<b>190</b>	BLINGO DRV40W1-10V BK	37268	<b>211</b>
ASTIM IP44 12W-NW-B	34933	<b>189</b>	BLINGO DRV42W DALI BK	37267	<b>211</b>
ASTIM IP44 12W-NW-C	34935	<b>189</b>	BLINGO DRV42W DALI BK	37267	<b>211</b>
ASTIM IP44 12W-NW-W	34934	<b>189</b>	BLINGO PU 36W 6262 NW	33188	<b>208</b>
ASTIM IP44 8W-NW-B	34930	<b>189</b>	BLINGO TN24-28W6060NW	33178	<b>208</b>
ASTIM IP44 8W-NW-C	34932	<b>189</b>	BLINGO TN38W 6060 NW	33177	<b>208</b>
ASTIM IP44 8W-NW-W	34931	<b>189</b>	BLINGO TUN48W 6060 NW	33179	<b>208</b>
ATL1 18W-930-S6-B	33131	<b>304</b>	BLINGO U EI25LM 120NW	37266	<b>210</b>
ATL1 18W-930-S6-W	33130	<b>304</b>	BLINGO U EI25LM 30NW	37271	<b>210</b>
ATL1 18W-940-S6-B	33133	<b>304</b>	BLINGO U EI25LM 60NW	37265	<b>210</b>
ATL1 18W-940-S6-W	33132	<b>304</b>	BLINGO U24W 4000 60NW	37179	<b>208</b>
ATL1 30W-930-S6-B	33135	<b>304</b>	BLINGO U34W 4080 120N	37175	<b>208</b>
ATL1 30W-930-S6-W	33134	<b>304</b>	BLINGO U34W 4080 60NW	37173	<b>208</b>
ATL1 30W-940-S6-B	33137	<b>304</b>	BLURRO 2xGU10 CO-B	32952	<b>113</b>
ATL1 30W-940-S6-W	33136	<b>304</b>	BLURRO 2xGU10 CO-W	32953	<b>113</b>
ATL2 GU10-B	33139	<b>306</b>	BOLA LED 2xUSB WW W	37397	<b>140</b>
ATL2 GU10-W	33138	<b>306</b>	BONSA LED 17,5W NW	37322	<b>115</b>
ATL3 GU10-B	33144	<b>306</b>	BORD DLP-50-B	22552	<b>111</b>
ATL3 GU10-W	33145	<b>306</b>	BORD DLP-50-W	22551	<b>111</b>
ATL4 GU10-B	33146	<b>307</b>	BORD XS DLP-50-B	25478	<b>112</b>
ATL4 GU10-W	33147	<b>307</b>	BORD XS DLP-50-W	25479	<b>112</b>
ATL5 GU10-B	33148	<b>307</b>	BRAVO DALI SET 36W	28508	<b>212</b>
ATL5 GU10-W	33149	<b>307</b>	BRAVO DRIVER 28W	28029	<b>212</b>
AVAR 6060 40W-CW	26771	<b>214</b>	BRAVO DRIVER 36W	28025	<b>212</b>
AVAR 6060 40W-NW	26770	<b>214</b>	BRAVO DRIVER 40W	28026	<b>212</b>
AVAR 6262 40W-NW	26773	<b>214</b>	BRAVO PU28W3060NW W	28551	<b>212</b>
AVAR 6262 40W-WW	26774	<b>214</b>	BRAVO PU36W6060NW W	28002	<b>212</b>
AVAR DALI SET 40W	28512	<b>214</b>	BRAVO S 40W12030NW W	28022	<b>212</b>
AZ-10A	22371	<b>333</b>	BRAVO S 40W6060NW W	28010	<b>212</b>
BART EL-235	7080	<b>277</b>	BRAVO S/P GRIP 12030	28501	<b>213</b>
BENO 18W NW-L-SE W	32946	<b>233</b>	BRAVO S/P GRIP 60-62	28500	<b>213</b>
BENO 18W NW-L-W	32942	<b>233</b>	BR-GZ10	72369	<b>340</b>
BENO 18W NW-O-SE W	32944	<b>233</b>	BTL 18W-930-B	35651	<b>308</b>
BENO 18W NW-O-W	32940	<b>233</b>	BTL 18W-930-W	35650	<b>308</b>
BENO 24W NW-L-GR	33343	<b>233</b>	BTL 18W-940-B	35653	<b>308</b>
BENO 24W NW-L-SE GR	33347	<b>233</b>	BTL 18W-940-W	35652	<b>308</b>
BENO 24W NW-L-SE W	33346	<b>233</b>	BTL 28W-930-B	35655	<b>308</b>
BENO 24W NW-L-W	33342	<b>233</b>	BTL 28W-930-W	35654	<b>308</b>
BENO 24W NW-O-GR	33341	<b>233</b>	BTL 28W-940-B	35657	<b>308</b>
BENO 24W NW-O-SE GR	33345	<b>233</b>	BTL 28W-940-W	35656	<b>308</b>
BENO 24W NW-O-SE W	33344	<b>233</b>	BTL 38W-930-B	35659	<b>308</b>
BENO 24W NW-O-W	33340	<b>233</b>	BTL 38W-930-W	35658	<b>308</b>
BENO N 18W NW-L-SE GR	32949	<b>233</b>	BTL 38W-940-B	35661	<b>308</b>
BENO N 18W NW-O-SE GR	32948	<b>233</b>	BTL 38W-940-W	35660	<b>308</b>
BERG AD-7L	276	<b>282</b>	BTLW 18W-930-B	35663	<b>309</b>
BERG AD-7O	36430	<b>282</b>	BTLW 18W-930-W	35662	<b>309</b>
BERG DL-10L	7173	<b>282</b>	BTLW 18W-940-B	35665	<b>309</b>
BERG DL-10O	7172	<b>282</b>	BTLW 18W-940-W	35664	<b>309</b>
BILO 4,9W E14-NW	23428	<b>64</b>	CALIZA LED CCT W	37390	<b>142</b>
BILO 4,9W E14-WW	23429	<b>64</b>	CARSA V2LED 12W-NW-W	28948	<b>260</b>
BILO 4,9W E27-NW	23418	<b>64</b>	CARSA V2LED 18W-NW-W	28949	<b>260</b>
BILO 4,9W E27-WW	23419	<b>64</b>	CARSA V2LED 24W-NW-W	33541	<b>260</b>
BILO 6,5W E14-NW	26766	<b>64</b>	CARVO LED 17,5W NW	37321	<b>114</b>
BILO 6,5W E14-WW	26767	<b>64</b>	CHIRO GU10 DTL-B	29313	<b>162</b>
BILO 6,5W E27-NW	26768	<b>64</b>	CHIRO GU10 DTO-B	29311	<b>162</b>
BILO 6,5W E27-WW	26769	<b>64</b>	CHIRO GU10 DTO-W	29310	<b>162</b>
BISO LED EL 8W-GR	29260	<b>275</b>	CIRCO LED 12VDC 0-10W	24240	<b>336</b>
BISO LED EL 8W-W	29261	<b>275</b>	CIRCO LED 12VDC 0-15W	24241	<b>336</b>
BLINGO 24W 4320 60NW	37178	<b>208</b>	CLIPS BRAVO S/P 12030	28503	<b>213</b>
BLINGO 34W 3740 60WW	37170	<b>208</b>	CLIPS BRAVO S/P 60-62	28502	<b>213</b>
BLINGO 34W 4080 120NW	37174	<b>208</b>	CLIPS PANEL 120	37338	<b>209</b>

# ALPHABETISCHER INDEX

## ALPHABETICAL INDEX

CLIPS PANEL 120	37338	211	ELICEO DSO W	35288	172
CLIPS PANEL 60-62	37337	209	ELICEO DSO W/G	35283	172
CLIPS PANEL 60-62	37337	211	ELICEO DSO W/W	35281	172
CL-MAH PLUS	18593	225	ELICEO DSO YG	35295	172
CL-MAH PLUS-INOX	18594	225	ELICEO-ST DSO B/B	35284	172
CLP-REGIS/PT	72333	216	ELICEO-ST DSO W/G	35287	172
CLP-REGIS/PT	72333	217	ELICEO-ST DSO W/W	35285	172
COB SET 3m DIM-NW	26327	86	ELNIS L A	27809	170
COB SET 3m DIM-WW	26326	86	ELNIS L A/C	27808	170
COLIE DTO-B	26743	177	ELNIS L B/G	27810	170
COLIE DTO-G	26741	177	ELNIS L W	27804	170
COLIE DTO-GR	26744	177	ELNIS L W/A	27805	170
COLIE DTO-W	26740	177	ELNIS L W/C	27806	170
CONNECT C/D/E/I	26563	89	ELNIS S W	27800	170
CONNECT C/D/E/I	26563	90	ENALI EL-10 B	28761	136
CONNECT-L B	26604	88	ENALI EL-10 W	28760	136
CONNECT-L C	26562	89	ENALI EL-21 B	28763	136
CONNECTOR 8	19030	79	ENALI EL-21 W	28762	136
CONNECTOR 8-CP	19032	79	ENALI EL-31 B	28767	136
CONNECTOR 8-CPC	19033	79	ENALI EL-31 W	28766	136
CONNECTOR RGB 10	19038	85	ENALI EL-30 B	28765	136
CONNECTOR RGB 10-CP	19036	85	ENALI EL-30 W	28764	136
CONNECTOR RGB 10-CPC	19037	85	ENALI EL-41 B	28769	136
CONTROLLER LED RGB-RF	22140	85	ENALI EL-41 W	28768	136
CTR L 12/24V MONO/CTT	22147	87	ERINUS LED L B-NW	33333	194
CTR L 12/24V RG BW CTT	22148	87	ERINUS LED L B-WW	33332	194
CYBER TM -6	1016	334	ERINUS LED L GR-NW	33327	194
CYKLON EOL 100	70910	338	ERINUS LED L W-NW	33321	194
CYKLON EOL 100B	70911	338	ERINUS LED L W-WW	33320	194
CYKLON EOL 100HT	70936	338	ERINUS LED LL B-NW	33337	194
CYKLON EOL 100P	70937	338	ERINUS LED LL B-WW	33336	194
CYKLON EOL 100T	70938	338	ERINUS LED LL GR-NW	33331	194
CYKLON EOL 120	70915	338	ERINUS LED LL GR-WW	33330	194
CYKLON EOL 120B	70916	338	ERINUS LED LL W-NW	33325	194
CYKLON EOL 120HT	70941	338	ERINUS LED LL W-WW	33324	194
CYKLON EOL 120P	70942	338	ERINUS LED O B-NW	33335	194
CYKLON EOL 120T	70943	338	ERINUS LED O B-WW	33334	194
CYKLON EOL 150	70920	338	ERINUS LED O GR-NW	33329	194
CYKLON EOL 150B	70921	338	ERINUS LED O W-NW	33323	194
CYKLON EOL 150P	70947	338	ERINUS LED O W-WW	33322	194
CYKLON EOL 150T	70948	338	ERTON 140 OP-W	35770	244
DABA N LED SMD DL-16W	19062	238	ERTON 240 OP-W	35771	244
DABA PRO 25W NW-B	19065	238	ESG LED 9W GX53-CW	22424	77
DABA PRO 26W NW-SE-W	19066	238	ESG LED 9W GX53-NW	22423	77
DALLA CT-DTL50-B	22433	171	ESG LED 9W GX53-WW	22422	77
DALLA CT-DTL50-W	22431	171	ETISSA D20 GR	27000	106
DALLA CT-DTO50-B	22432	171	EVALO EL-11 B-SR	35691	126
DALLA CT-DTO50-W	22430	171	EVALO EL-11 W-SR	35690	126
DASTO 2SOC FR B	36585	302	EVALO EL-21 B-SR	35693	126
DERATO EL-10 B-SR	35640	124	EVALO EL-21 W-SR	35692	126
DERATO EL-10 W-SR	35641	124	EVALO EL-31 B-SR	35695	126
DERATO EL-21 B-SR	35642	124	EVALO EL-31 W-SR	35694	126
DERATO EL-21 W-SR	35643	124	EVALO EL-41 B-SR	35699	126
DERATO EL-30 B-SR	35644	124	EVALO EL-41 W-SR	35698	126
DERATO EL-30 W-SR	35645	124	EVALO EL-40 B-SR	35697	126
DERATO EL-41 B-SR	35646	124	EVALO EL-40 W-SR	35696	126
DERATO EL-41 W-SR	35647	124	EVALO EL-51 B-SR	35689	126
DRIVE LED 0-15W 12VDC	23860	336	EVALO EL-51 W-SR	35688	126
DROXY IP65 DSO-B	33126	186	EVALO FL 3xGU10 B-SR	35788	149
DROXY IP65 DSO-W	33125	186	EVALO FL 3xGU10 W-SR	35787	149
DULI LED 4W-NW-L-GR	33750	278	EVALO TL GU10 B-SR	35786	148
DULI LED 4W-NW-O-GR	33751	278	EVALO TL GU10 W-SR	35785	148
DULI LED 6,5W-NW-L-GR	33752	278	EVIT CT-DTL50-AL	18560	178
DULI LED 6,5W-NW-O-GR	33753	278	EVIT CT-DTO50-AL	18561	178
DUN 4,9W E14-NW	23435	59	EXATE LED 17,5W NW	37323	115
DUN 4,9W E14-WW	23434	59	FELINE DSL B/B	37256	159
DUN 6,5W E14-NW	23436	59	FELINE DSL B/W	37260	159
DUN 6,5W E14-WW	23437	59	FELINE DSL G/B	37257	159
ELICEO DSO B	35289	172	FELINE DSL G/W	37261	159
ELICEO DSO B/B	35280	172	FELINE DSL W/B	37258	159
ELICEO DSO BL	35298	172	FELINE DSL W/W	37259	159
ELICEO DSO GR	35296	172	FELINE DSO B/B	37250	158
ELICEO DSO PK	35297	172	FELINE DSO B/W	37255	158

FELINE DSO G/B	37251	158	GLOZO DSO SR/B	36225	156
FELINE DSO G/W	37254	158	GLOZO DSO SR/W	36221	156
FELINE DSO W/B	37252	158	GLOZO DSO W/B	36222	156
FELINE DSO W/W	37253	158	GLOZO DSO W/W	36218	156
FL AGOR HI 240W NW	33476	263	GORD XS DLP 50-B	25476	112
FL AGOR HI 300W NW	33478	263	GORD XS DLP 50-W	25477	112
FL AGOR HI GRID 240W	33482	263	GORDO N 1W CW-L-SR	18192	281
FL AGOR HI GRID 300W	33483	263	GORDO N 1W CW-O-SR	18193	281
FL AGOR LED 100W NW	33470	262	GORI 50	29002	292
FL AGOR LED 150W NW	33471	262	GORI 80	29003	292
FL AGOR LED 200W NW	33472	262	GORI EL 135 D	29000	292
FL AGOR/A HI 240W NW	33477	263	GORI EL 235 D	29001	292
FL AGOR/A HI 300W NW	33479	263	GOVIK DSO-B A	29236	160
FL AGOR/A LED 100W	33473	262	GOVIK DSO-B/G	29232	160
FL AGOR/A LED 150W	33474	262	GOVIK DSO-W A	29235	160
FL AGOR/A LED 200W	33475	262	GOVIK DSO-W/G	29231	160
FL SOLNAR SLR 8W NW-B	36605	269	GOVIK-ST DSO-B	29237	160
FL SONE SLR L NW-GR	36607	268	GOVIK-ST DSO-B/G	29234	160
FL SONE SLR M NW-GR	36606	268	GOVIK-ST DSO-W	29238	160
FLINI IP44 DSL-B	33120	186	GOVIK-ST DSO-W/G	29233	160
FLINI IP44 DSL-W	33121	186	GRIBLO 7 GR	36432	300
FLINI IP44 DSO-B	33122	186	GRIP GP\S	4862	339
FLINI IP44 DSO-W	33123	186	GRIP W\US	4863	339
FLUXY LED IP44 B	37311	146	GRL 11M10E27-B	35754	301
FLUXY LED IP44 BL	37312	146	GRL 15M15E27-B	35758	301
FLUXY LED IP44 GN	37313	146	GRL 6M5E27-B	35750	301
FLUXY LED IP44 W	37310	146	GWEN CT-DTL50-B	18530	178
FLUXY LED IP44 Y	37314	146	GWEN CT-DTO50-B	18531	178
FOGLER DL-2400	18120	242	HANDLE B/F	26596	88
FOGLER LED 14W-NW	18121	242	HANDLE B/F	26596	91
FRANCO 15LED SMD KT-B	22341	155	HANDLE C/D/E/I	26597	89
FRANCO 15LED SMD KT-W	22340	155	HANDLE C/D/E/I	26597	90
FUTURIO LED	xxx	28	HANDLE G	26598	92
G9-20W STAR	18420	99	HANDLE H	26599	93
G9-33W STAR	18421	99	HANDLE J/K	26595	94
G9-48W STAR	18422	99	HANDLE J/K	26595	95
G9-60W STAR	18423	99	HANDLE SIDE H	26600	93
GALOBA EL-10 B	33671	130	HAXA-DSO POWER LED-B	8103	204
GALOBA EL-10 W	33670	130	HB PRO LED HI 100W-NW	27155	272
GALOBA EL-21 B	33675	130	HB PRO LED HI 150W-NW	27156	272
GALOBA EL-21 W	33674	130	HB PRO LED HI 200W-NW	27157	272
GALOBA EL-31 B	33677	130	HBPH GRID 100W	33196	273
GALOBA EL-31 W	33676	130	HBPH GRID 150W	33197	273
GALOBA EL-41 B	33681	130	HBPH GRID 200W	33198	273
GALOBA EL-41 W	33680	130	HBPH LENS 120D 100W	33193	273
GALOBA EL-40 B	33679	130	HBPH LENS 120D 150W	33194	273
GALOBA EL-40 W	33678	130	HBPH LENS 120D 200W	33195	273
GALOBA W 1xGU10 B	33673	143	HBPH LENS 50D 100W	33190	273
GALOBA W 1xGU10 W	33672	143	HBPH LENS 50D 150W	33191	273
GARTO LED EL 8W-GR	29270	275	HBPH LENS 50D 200W	33192	273
GARTO LED EL 8W-W	29271	275	HERMI 7063NB	70524	245
GAVI CT-2116B-C	811	205	HERON II LED B	27602	152
GAVI CT-2116B-C/M	815	205	HERON II LED W	27603	152
GAVI CT-2116B-W	810	205	HIERRO LED	xxx	26
GAVI LED18 SMD-WW-C/M	19761	205	HIMA LED 23W-NW-B	22842	248
GLASI LED 3W P NW-B	33694	279	HIMA LED 23W-NW-W	22841	248
GLASI LED 3W P NW-GR	33695	279	HIMA LED 33W-NW-B	22844	248
GLASI LED 3W P NW-W	33693	279	HIMA LED 33W-NW-W	22843	248
GLASI LED 3W P WW-B	33691	279	HLDR-E14	2170	341
GLASI LED 3W P WW-GR	33692	279	HLDR-E14-F	2173	341
GLASI LED 3W P WW-W	33690	279	HLDR-E27	2160	341
GLOZO DSL B/B	36215	157	HLDR-E27-D	2162	342
GLOZO DSL B/W	36211	157	HLDR-E27-F	2161	342
GLOZO DSL G/B	36216	157	HLDR-G9	8220	342
GLOZO DSL G/W	36212	157	HLDR-GX5,3	72109	343
GLOZO DSL SR/B	36217	157	HLDR-GZ10	402	343
GLOZO DSL SR/W	36213	157	HLDR-R7S	405	343
GLOZO DSL W/B	36214	157	HOFI LED WW W	37393	141
GLOZO DSL W/W	36210	157	HORN CTC-3114-GM/N	2824	181
GLOZO DSO B/B	36223	156	IDO 6,5W E14-NW	23438	59
GLOZO DSO B/W	36219	156	IDO 6,5W E14-WW	23439	59
GLOZO DSO G/B	36224	156	IMBER LED CW	23521	188
GLOZO DSO G/W	36220	156	IMBER LED NW	23520	188
			IMBER LED WW	23522	188



**ALPHABETISCHER INDEX**  
ALPHABETICAL INDEX

IMINES DSO-W	29031	165	IQ-LED G45E27 3,4W-CW	36693	60
INES 7061N	70525	246	IQ-LED G45E27 3,4W-NW	36692	60
INITA LED IP54 B	36321	147	IQ-LED G45E27 3,4W-WW	36691	60
INITA LED IP54 GN	36320	147	IQ-LED G45E27 5,9W-CW	36699	60
INITA LED IP54 R	36322	147	IQ-LED G45E27 5,9W-NW	36698	60
INITA LED IP54 W	36324	147	IQ-LED G45E27 5,9W-WW	36697	60
INITA LED IP54 Y	36323	147	IQ-LED GU 10 4,9W-CW	35258	65
INVO OP 107-L-GR	29173	294	IQ-LED GU 10 4,9W-NW	35257	65
INVO OP 47-L-GR	29171	294	IQ-LED GU 10 4,9W-WW	35256	65
INVO OP 77-L-GR	29172	294	IQ-LED GU10 6,5W-CW	35242	66
INVO OP EL-53-L-GR	29170	294	IQ-LED GU10 6,5W-NW	35241	66
INVO TR 107-O-GR	29177	295	IQ-LED GU10 6,5WS3-CW	35245	66
INVO TR 47-O-GR	29175	295	IQ-LED GU10 6,5WS3-NW	35244	66
INVO TR 77-O-GR	29176	295	IQ-LED GU10 6,5WS3-WW	35243	66
INVO TR EL-53-O-GR	29174	295	IQ-LED GU10 6,5W-WW	35240	66
IPER LED 10W-NW-L	37294	230	IQ-LED Life A60 7,2W-NW	33763	38
IPER LED 10W-NW-L-SE	37302	230	IQ-LED Life A60 7,2W-WW	33762	38
IPER LED 10W-NW-O	37290	230	IQ-LED Life G45 4,2W-NW	33761	38
IPER LED 10W-NW-O-SE	37298	230	IQ-LED Life G45 4,2W-WW	33760	38
IPER LED 19W-NW-L	37295	230	IQ-LED Life GU10 4,8W-NW	33765	38
IPER LED 19W-NW-L-SE	37303	230	IQ-LED Life GU10 4,8W-WW	33764	38
IPER LED 19W-NW-O	37291	230	IQ-LEDDIM A60 7,3W-NW	33723	42
IPER LED 19W-NW-O-SE	37299	230	IQ-LEDDIM A60 7,3W-WW	33722	42
IPER LED 26W-NW-L	37296	230	IQ-LEDDIM A6010,5W-NW	33725	42
IPER LED 26W-NW-L-SE	37304	230	IQ-LEDDIM A6010,5W-WW	33724	42
IPER LED 26W-NW-O	37292	230	IQ-LEDDIM A6013,6W-NW	33727	42
IPER LED 26W-NW-O-SE	37300	230	IQ-LEDDIM A6013,6W-WW	33726	42
IPER LED 35W-NW-L	37297	230	IQ-LEDDIM GU10 7W-CW	35248	67
IPER LED 35W-NW-L-SE	37305	230	IQ-LEDDIM GU10 7W-NW	35247	67
IPER LED 35W-NW-O	37293	230	IQ-LEDDIM GU10 7W-WW	35246	67
IPER LED 35W-NW-O-SE	37301	230	IQ-LEDEX GU 10 2,5W-NW	33769	65
IQ-LED A60 11W-CW	36681	40	IRS3xAAA LED PIR W-NW	37392	200
IQ-LED A60 11W-NW	36680	40	IT-1\20-RE	1273	351
IQ-LED A60 11W-WW	36679	40	IT-1\20-Y	1272	351
IQ-LED A60 3,4W-CW	36672	40	IT-1\20-Y\GN	1277	351
IQ-LED A60 3,4W-NW	36671	40	ITECH C1 302 STW	33823	346
IQ-LED A60 3,4W-WW	36670	40	ITECH C1 302MATW	33815	346
IQ-LED A60 5,9W-CW	36675	40	ITECH C2 105MATW	33834	346
IQ-LED A60 5,9W-NW	36674	40	ITECH F1 302MATW	33835	346
IQ-LED A60 5,9W-WW	36673	40	ITECH F2 105MATW	33836	346
IQ-LED A60 7,8W-CW	36678	40	ITECH F2 105MSTW	33824	346
IQ-LED A60 7,8W-NW	36677	40	ITECH M1 60 NM ST W	27769	346
IQ-LED A60 7,8W-WW	36676	40	ITECH M2 302MATW	33812	346
IQ-LED A67 N 19W-CW	33748	41	ITECH M2 302MSTW	33821	346
IQ-LED A67 N 19W-NW	33747	41	ITECH M5 105MATW	33832	346
IQ-LED A67 N 19W-WW	33746	41	ITECH M5 105MSTW	33822	346
IQ-LED AR-111 13W-NW	35253	72	ITECH M5 305MATW	33814	346
IQ-LED AR-111 13W-WW	35252	72	ITECH S1 302MATW	33833	346
IQ-LED C35E14 3,4W-NW	36683	56	ITECH W2 105MATW	33837	346
IQ-LED C35E14 3,4W-VW	36684	56	IVIAN LED 4,5W SN-NW	25783	253
IQ-LED C35E14 3,4W-WW	36682	56	IVIAN LED 4,5W SN-WW	25781	253
IQ-LED C35E14 5,9W-CW	36687	56	IVIAN LED 4,5W W-NW	25782	253
IQ-LED C35E14 5,9W-NW	36686	56	IVIAN LED 4,5W W-WW	25780	253
IQ-LED C35E14 5,9W-WW	36685	56	IVRI DTO-W	26736	175
IQ-LED ES-111 12W-NW	27319	72	J-1000W 189MM	10418	99
IQ-LED ES-111 12W-WW	27318	72	J-120W 118MM STAR	8500	100
IQ-LED EX T8 12W-CW	35255	73	J-120W 78MM STAR	8491	100
IQ-LED EX T8 12W-NW	35254	73	J-80W 78MM STAR	8490	100
IQ-LED FL QC I 3x1MM2	33889	264	JASMIN 270-B	29207	122
IQ-LED FL-10W-NW	33880	264	JASMIN 270-G/O	36440	122
IQ-LED FL-10W-NW-SE	33885	264	JASMIN 270-W	23123	122
IQ-LED FL-20W-NW	33881	264	JASMIN 270-W/M	23126	122
IQ-LED FL-20W-NW-SE	33886	264	JASMIN 270-WE	23120	122
IQ-LED FL-30W-NW	33882	264	JASMIN 370-B	29208	122
IQ-LED FL-30W-NW-SE	33887	264	JASMIN 370-G/O	36441	122
IQ-LED FL-50W-NW	33883	264	JASMIN 370-W	23124	122
IQ-LED FL-50W-NW-SE	33888	264	JASMIN 370-W/M	23127	122
IQ-LED FL-90W-NW	33884	264	JASMIN 370-WE	23121	122
IQ-LED G45E14 3,4W-CW	36690	60	JASMIN 470-B	29205	122
IQ-LED G45E14 3,4W-NW	36689	60	JASMIN 470-G/O	36442	122
IQ-LED G45E14 3,4W-WW	36688	60	JASMIN 470-W	23125	122
IQ-LED G45E14 5,9W-CW	36696	60	JASMIN 470-W/M	23128	122
IQ-LED G45E14 5,9W-NW	36695	60	JASMIN 470-WE	23122	122
IQ-LED G45E14 5,9W-WW	36694	60	JASMIN B-W	29209	121

JASMIN C 270-B	36505	105	LCOB 10W/M 12 IP00-NW	37231	83
JASMIN C 270-G/O	36499	105	LCOB 10W/M 12 IP00-WW	37230	83
JASMIN C 270-W/M	36502	105	LCOB 10W/M 12 IP65-NW	37233	83
JASMIN C 370-B	36506	105	LCOB 10W/M 12 IP65-WW	37232	83
JASMIN C 370-G/O	36500	105	LCOB 10W/M 24 IP00-NW	33368	84
JASMIN C 370-W/M	36503	105	LCOB 10W/M 24 IP65-NW	33369	84
JASMIN C 470-B	36507	105	LCOB 8W/M 12 IP00-NW	33366	83
JASMIN C 470-G/O	36501	105	LCOB 8W/M 12 IP00-WW	33364	83
JASMIN C 470-W/M	36504	105	LCOB 8W/M 12 IP65-NW	33367	83
JASMIN G/O-W	36443	121	LCOB 8W/M 12 IP65-WW	33365	83
JASMIN W/M-W	23758	121	LED12 G4-NW	18503	71
JASMIN WE-W	23756	121	LED12 G4-WW	18502	71
JASMIN W-W	23757	121	LEDS-B 4 8W/M IP00-CW	24518	79
JURBA DL-218L	8981	240	LEDS-B 4 8W/M IP00-NW	24517	79
JURBA DL-218O	8980	240	LEDS-B 4 8W/M IP00-WW	24516	79
JUSI E27 B	36271	151	LEDS-B 4 8W/M IP65-CW	24515	79
JUSI E27 W	36270	151	LEDS-B 4 8W/M IP65-NW	24514	79
K LED GU10 6W-CW	36332	67	LEDS-B 4 8W/M IP65-WW	24513	79
K LED GU10 6W-NW	36331	67	LEDS-B 7 2W/M IP00RGB	24530	85
K LED N GU10 6W-WW	36333	67	LEDS-B 7 2W/M IP54RGB	24532	85
KANTI V2LED 12W-NW-SN	27212	261	LEDS-B 7 2W/M IP65RGB	24531	85
KANTI V2LED 12W-NW-W	28950	261	LIEGO 37 B	36534	290
KANTI V2LED 18W-NW-SN	27213	261	LIEGO 89 PEND B	36531	290
KANTI V2LED 18W-NW-W	28951	261	LIEGO 97 B	36530	290
KATRO V2LED 12W-NW-SR	28939	258	LIEGO EL 28 UP B	36532	290
KATRO V2LED 12W-NW-W	28940	258	LIEGO EL 28 UP SE B	36533	290
KATRO V2LED 12W-WW-W	28941	258	LINUS LED 4W-NW	27590	204
KATRO V2LED 18W-NW-SR	28942	258	LINUS LED 7W-NW	27591	204
KATRO V2LED 18W-NW-W	28943	258	LINUS LINK	14977	204
KATRO V2LED 24W-NW-SN	27216	258	LUMKO LED 17,5W NW	37320	114
KATRO V2LED 24W-NW-W	28945	258	LUTO CTX-DS02B-AB	2584	179
KATRO V2LED 6W-NW-W	28946	258	LUTO CTX-DS02B-C/M	2583	179
LI20 16W/M 12 IP00CCT	33317	82	LUTO CTX-DS02B-W	2580	179
LI20 16W/M 24 IP00-NW	33312	81	LUTO CTX-DT02B-C	2591	179
LI20 16W/M 24 IP00-WW	33311	81	LUTO CTX-DT02B-W	2590	179
LI20 16W/M 24 IP65-NW	33315	81	MAH LED HI 19W-NW RYF	22606	222
LI20 16W/M 24 IP65-WW	33314	81	MAH LED HI 26W-NW RYF	22609	222
LI20B 16W/M 24IP00-NW	33356	81	MAH LED HI 38W-NW RYF	22607	222
LI20B 16W/M 24IP00-WW	33355	81	MAH LED HI 48W-NW RYF	22608	222
L48 9W/M 24 IP00-RGBW	33318	86	MAH PLUS-136/4LED/PC	22802	224
L48 9W/M 24 IP65-RGBW	33319	86	MAH PLUS-158/4LED/PC	22803	224
L60 11W/M 12 IP00-CW	33304	80	MAH PLUS-236/4LED/PC	22800	224
L60 11W/M 12 IP00-NW	33303	80	MAH PLUS-236-ABS/PC	18521	225
L60 11W/M 12 IP00-WW	33302	80	MAH PLUS-258/4LED/PC	22801	224
L60 11W/M 12 IP65-CW	33310	80	MAH-LED N 20W-NW/PC	22603	223
L60 11W/M 12 IP65-NW	33309	80	MAH-LED N 40W-NW/PC	22604	223
L60 11W/M 12 IP65-WW	33308	80	MAH-LED N 50W-NW/PC	22605	223
L60B 11W/M 12 IP00-CW	33307	80	MARC DL-60	7015	243
L60B 11W/M 12 IP00-NW	33306	80	MARID JQ-L	8910	328
L60B 11W/M 12 IP00-WW	33305	80	MARIN CT-S80-AB	4710	187
LARATA E27 B	36261	145	MARIN CT-S80-B	32501	187
LARATA E27 W	36260	145	MARIN CT-S80-C	4703	187
LARATA EL-10 B	36263	145	MARIN CT-S80-SN	4704	187
LARATA EL-10 W	36262	145	MARIN CT-S80-W	32500	187
LART EL-160-GR	29832	277	MATEO ES DLP-150-B	32930	253
LART EL-260-GR	29833	277	MATEO ES DLP-150-W	32931	253
LAURIN EL-10 B	29121	132	MATEO ES DLP-250-B	32932	253
LAURIN EL-10 W	29120	132	MATEO ES DLP-250-W	32933	253
LAURIN EL-21 B	29123	132	MEBA 4LED 120 IP54 PC	33895	226
LAURIN EL-21 W	29122	132	MEBA 4LED 150 IP54 PC	33896	226
LAURIN EL-31 B	29125	132	MEBA 4LED 2X120 OP PS	26964	227
LAURIN EL-31 W	29124	132	MEBA 4LED 2X120 PS	26961	227
LAURIN EL-30 B	29127	132	MEBA 4LED 2X150 OP PS	26965	227
LAURIN EL-30 W	29126	132	MEBA 4LED 60 IP54 PC	33894	226
LAURIN EL-40 B	29129	132	MEBA LED 12-20W NW/WW	33890	227
LAURIN EL-40 W	29128	132	MEBA LED 20W IP54 NW	33892	226
LAVEN 50 GR	36546	287	MEBA LED 22-40W NW/WW	33891	227
LAVEN 80 GR	36545	287	MEBA LED 40W IP54 NW	33893	226
LAVEN EL 25 GR	36548	287	MEFIS LED B-NW	32497	200
LAVEN EL 28 SE-GR	36547	287	MEFIS LED W-NW	32495	200
LCO B 10W/M 24 IP00-CW	33353	84	MERA LED 10W NW	29211	203
LCO B 10W/M 24 IP00-WW	33351	84	MERA LED 15W NW	29212	203
LCO B 10W/M 24 IP65-CW	33354	84	MERA LED 20W NW	29213	203
LCO B 10W/M 24 IP65-WW	33352	84	MERA LED 5W NW	29210	203

MERA LED PP	29214	<b>203</b>	OFIS S LED	xxx	<b>24</b>
MERGE ADJ-O	23451	<b>331</b>	OGIVA D35 GR	27001	<b>106</b>
MERGE JQ-L	7690	<b>328</b>	ONTEC C C160NMATW	33849	<b>347</b>
MERGE JQ-O	7691	<b>330</b>	ONTEC C C160NMSTW	33868	<b>347</b>
MERGE MW-L	23453	<b>331</b>	ONTEC C M160NMATW	33847	<b>347</b>
MERGE-WT-O-W	37370	<b>325</b>	ONTEC C M160NMSTW	33858	<b>347</b>
MILENO EL-10 ASR-AN	29111	<b>138</b>	ONTEC G E1E 301 M STW	28976	<b>347</b>
MILENO EL-10 B-AG	29110	<b>138</b>	ONTEC G E1E180MATW	28979	<b>347</b>
MILENO EL-2I ASR-AN	29115	<b>138</b>	ONTEC R C1 60N M STW	33826	<b>348</b>
MILENO EL-2I B-AG	29114	<b>138</b>	ONTEC R M1 60N M ATW	33850	<b>348</b>
MILENO EL-3I ASR-AN	29117	<b>138</b>	ONTEC R M1 60N M STW	29098	<b>348</b>
MILENO EL-3I B-AG	29116	<b>138</b>	ONTEC R M2 302 M ATW	33851	<b>348</b>
MILENO EL-3O ASR-AN	29113	<b>138</b>	ONTEC R M2 302 M ATW	33852	<b>348</b>
MILENO EL-3O B-AG	29112	<b>138</b>	ONTEC S 20M1X AT W	27529	<b>344</b>
MILENO EL-4I ASR-AN	29119	<b>138</b>	ONTEC S 20M1X ST W	27528	<b>344</b>
MILENO EL-4I B-AG	29118	<b>138</b>	ONTEC S C1302MATW	33842	<b>344</b>
MILO 7040T	70522	<b>245</b>	ONTEC S C1302MATWCLD	28977	<b>344</b>
MILO 7040T/P	70523	<b>245</b>	ONTEC S C1302MSTW	33862	<b>344</b>
MILO 7040T/P-B	8092	<b>245</b>	ONTEC S C160NMATW	28978	<b>344</b>
MINI BORD DLP-50-B	28783	<b>164</b>	ONTEC S C2105MATW	33843	<b>344</b>
MINI BORD DLP-50-W	28782	<b>164</b>	ONTEC S F2105MATW	33844	<b>344</b>
MINI GORD DLP-50-B	28781	<b>163</b>	ONTEC S F2105MSTW	33864	<b>344</b>
MINI GORD DLP-50-W	28780	<b>163</b>	ONTEC S M1180MATW	28973	<b>344</b>
MINI RITI GU10 B/B	27578	<b>163</b>	ONTEC S M1180MSTW	27527	<b>344</b>
MINI RITI GU10 B/G	27575	<b>163</b>	ONTEC S M2102MATWCLD	33819	<b>344</b>
MINI RITI GU10 B/W	27577	<b>163</b>	ONTEC S M2302MATW	36382	<b>344</b>
MINI RITI GU10 W/G	27576	<b>163</b>	ONTEC S M2302MATWCLD	33818	<b>344</b>
MINI RITI GU10 W/W	27579	<b>163</b>	ONTEC S M2302MSTW	36381	<b>344</b>
MODv2 LED 12W-NW	29301	<b>78</b>	ONTEC S M2302MSTWCLD	33856	<b>344</b>
MODv2 LED 12W-WW	29300	<b>78</b>	ONTEC S M5105MATW	33840	<b>344</b>
MODv2 LED 19W-NW	29303	<b>78</b>	ONTEC S M5105MSTW	33855	<b>344</b>
MODv2 LED 19W-WW	29302	<b>78</b>	ONTEC S M5305MATW	33841	<b>344</b>
MORO N IG-20	18194	<b>283</b>	ONTEC S W1302MATW	33845	<b>344</b>
MORTA B CT-DSL50-B	22110	<b>174</b>	ONTEC S W1302MATWCLD	33810	<b>344</b>
MORTA B CT-DSL50-SR	22112	<b>174</b>	ONTEC S W1302MSTW	33865	<b>344</b>
MORTA B CT-DSO50-B	22116	<b>174</b>	ONTEC S W1302MSTWCLD	33866	<b>344</b>
MORTA B CT-DSO50-SR	22117	<b>174</b>	ONTEC S W2105MATWCLD	33846	<b>344</b>
MORTA CT-DSL50-B	18510	<b>173</b>	ONTECSCI302MATW	27652	<b>344</b>
MORTA CT-DSL50-SR	18512	<b>173</b>	OPRAWA DWUSTRONNA OSO	33829	<b>345</b>
MORTA CT-DSO50-B	19440	<b>173</b>	ORISA LED WW B	37395	<b>141</b>
MORTA CT-DSO50-SR	19442	<b>173</b>	ORISA LED WW W	37394	<b>141</b>
MORTA CT-DTL50-B	26719	<b>173</b>	ORTE LED 18W-NW-O	29160	<b>237</b>
MORTA CT-DTL50-SR	26718	<b>173</b>	ORTE LED 18W-NW-O-SE	29162	<b>237</b>
MORTA CT-DTO50-B	26717	<b>173</b>	ORTE LED 24W-NW-O	29161	<b>237</b>
MORTA CT-DTO50-SR	26716	<b>173</b>	ORTE LED 24W-NW-O-SE	29163	<b>237</b>
MORTA OCT-B	26715	<b>174</b>	OYO 5LED-CW	8121	<b>188</b>
MORTA OCT-SR	26714	<b>174</b>	PEVO 50 GR	36551	<b>286</b>
NASTO 2SOC FR B	36586	<b>302</b>	PEVO 80 GR	36550	<b>286</b>
NAVI CTX-DS10-B	25990	<b>179</b>	PEVO EL 25 GR	36552	<b>286</b>
NAVI CTX-DT10-B	25991	<b>179</b>	PICTO ONTEC G D2	27483	<b>349</b>
NAVI CTX-DT10-C/M	2553	<b>179</b>	PICTO ONTEC G D3	27484	<b>349</b>
NAVI CTX-DT10-W	2550	<b>179</b>	PICTO ONTEC G D5	27482	<b>349</b>
NEDIA E14 B	34475	<b>151</b>	PICTO ONTEC G D7	27488	<b>349</b>
NEDIA E14 W	34476	<b>151</b>	PICTO ONTEC G D8	27485	<b>349</b>
NEON END CAP	37239	<b>96</b>	PICTO ONTEC G DB	27499	<b>349</b>
NEON END CAP HOLE	37238	<b>96</b>	PICTO ONTEC G DC	27500	<b>349</b>
NEON LED12W/M IP65-BL	37237	<b>96</b>	PICTO ONTEC G F1	27497	<b>349</b>
NEON LED12W/M IP65-CW	37236	<b>96</b>	PICTO ONTEC G F2	27498	<b>349</b>
NEON LED12W/M IP65-NW	37235	<b>96</b>	PICTO ONTEC G W1	27490	<b>349</b>
NEON LED12W/M IP65-WW	37234	<b>96</b>	PICTO ONTEC S D1	27509	<b>350</b>
NEON MOUNTING CLIP	37229	<b>96</b>	PICTO ONTEC S D2	27506	<b>350</b>
NESTA DSL-C	26747	<b>177</b>	PICTO ONTEC S D3	27507	<b>350</b>
NESTA DSL-C/M	26748	<b>177</b>	PICTO ONTEC S D4	27512	<b>350</b>
NESTA DTL-C	26751	<b>177</b>	PICTO ONTEC S D5	27505	<b>350</b>
NESTA DTL-C/M	26752	<b>177</b>	PICTO ONTEC S D6	27510	<b>350</b>
NOTUS 3 EVG 218 NT	19733	<b>218</b>	PICTO ONTEC S D7	27511	<b>350</b>
NOTUS 3 EVG 236 NT	19732	<b>218</b>	PICTO ONTEC S D8	27508	<b>350</b>
NOTUS 3 EVG 418 NT	19731	<b>218</b>	PICTO ONTEC S DB	27522	<b>350</b>
NOTUS 3WS EVG 236 NT	25712	<b>218</b>	PICTO ONTEC S DC	27523	<b>350</b>
NOTUS 3WS EVG 418 NT	25711	<b>218</b>	PICTO ONTEC S F1	27520	<b>350</b>
NOTUS 4LED 218 NT	22674	<b>219</b>	PICTO ONTEC S W1	27513	<b>350</b>
NOTUS 4LED 236 NT	22672	<b>219</b>	PICTO ONTEC S W2	27514	<b>350</b>
NOTUS 4LED 418 NT	22671	<b>219</b>	PIN W\US	2186	<b>339</b>

PIRES DL-600	8810	<b>241</b>	REGIS 4LED OPAL 418PT	19736	<b>217</b>
PIRES DL-600 NS	8811	<b>241</b>	REKA LED EL 7W-L-GR	28990	<b>274</b>
PIRES ECO DL-250	19000	<b>241</b>	REKA LED EL 7W-L-W	28992	<b>274</b>
PIRES ECO DL-250 NS	19001	<b>241</b>	REKA LED EL 7W-O-GR	28991	<b>274</b>
PIXA KT-40-B	19301	<b>152</b>	REKA LED EL 7W-O-W	28993	<b>274</b>
PIXA KT-40-W	19300	<b>152</b>	REMI LED GU 10-CW	33082	<b>69</b>
PLAFMIN O	25690	<b>244</b>	REMI LED GU 10-NW	33080	<b>69</b>
POWELED P 12V 100W	28961	<b>335</b>	REMI LED GU 10-WW	33081	<b>69</b>
POWELED P 12V 150W	28963	<b>335</b>	REMOTE CCT	22145	<b>87</b>
POWELED P 12V 200W	28965	<b>335</b>	REMOTE MONO	22144	<b>87</b>
POWELED P 12V 30W	26810	<b>335</b>	REMOTE RGBW	22146	<b>87</b>
POWELED P 12V 60W	26811	<b>335</b>	REXAR LED B	33071	<b>155</b>
POWELED P 24V 100W	28962	<b>335</b>	REXAR LED W	33070	<b>155</b>
POWELED P 24V 150W	28964	<b>335</b>	RIFA LED 17,5W NW B/G	36464	<b>118</b>
POWELED P 24V 200W	28966	<b>335</b>	RIFA LED 17,5W NW B/W	36462	<b>118</b>
POWELED P 24V 30W	26815	<b>335</b>	RIFA LED 17,5W NW N1	36468	<b>118</b>
POWELED P 24V 60W	26816	<b>335</b>	RIFA LED 17,5W NW N2	35508	<b>118</b>
PREDA LED B	35780	<b>154</b>	RIFA LED 17,5W NW W/W	36460	<b>118</b>
PREDA LED W	35781	<b>154</b>	RIFA LED 17,5W WW B/G	36465	<b>118</b>
PRESO 30 GR	36542	<b>288</b>	RIFA LED 17,5W WW B/W	36463	<b>118</b>
PRESO 50 GR	36541	<b>288</b>	RIFA LED 17,5W WW N1	36469	<b>118</b>
PRESO 80 GR	36540	<b>288</b>	RIFA LED 17,5W WW N2	35509	<b>118</b>
PRESO EL 18 GR	36543	<b>288</b>	RIFA LED 17,5W WW W/W	36461	<b>118</b>
PROFILO B	19161	<b>88</b>	RIFA LED 17,5W WW W/W	36466	<b>118</b>
PROFILO B 2m	26540	<b>88</b>	RIFA LED 17,5W WW GR/G	36467	<b>118</b>
PROFILO C	19162	<b>89</b>	RIFA LED 17,5W WW GR/G	36467	<b>118</b>
PROFILO C 2m	26541	<b>89</b>	RITI GU10 B/B	27567	<b>111</b>
PROFILO D	19163	<b>90</b>	RITI GU10 B/G	27571	<b>111</b>
PROFILO D 2m	26542	<b>90</b>	RITI GU10 W/G	27570	<b>111</b>
PROFILO F	26552	<b>91</b>	RITI GU10 W/W	27569	<b>111</b>
PROFILO F 2m	26553	<b>91</b>	ROGER DL-2LED6	7281	<b>281</b>
PROFILO G	26558	<b>92</b>	ROGER DL-LED12	7280	<b>281</b>
PROFILO G 2m	26559	<b>92</b>	ROLF JQ-L	8820	<b>329</b>
PROFILO H	26560	<b>93</b>	ROLF JQ-O	8821	<b>330</b>
PROFILO H 2m	26561	<b>93</b>	ROLF MINI JQ-L	8822	<b>329</b>
PROFILO J	26544	<b>94</b>	ROLSO LED IP44 15W-NW	26700	<b>189</b>
PROFILO J 2M	26545	<b>94</b>	ROPE-NT 150	7870	<b>218 / 219</b>
PROFILO J-W	26546	<b>94</b>	ROPE-NT 150 SINGLE	7871	<b>218 / 219</b>
PROFILO J-W 2M	26547	<b>94</b>	ROUNDA V2LED12W-NW-SR	28930	<b>256</b>
PROFILO K	26548	<b>95</b>	ROUNDA V2LED12W-NW-W	28931	<b>256</b>
PROFILO K 2m	26549	<b>95</b>	ROUNDA V2LED12W-WW-W	28932	<b>256</b>
PROFILO K-W	26550	<b>95</b>	ROUNDA V2LED18W-NW-SR	28933	<b>256</b>
PROFILO K-W 2m	26551	<b>95</b>	ROUNDA V2LED18W-NW-W	28934	<b>256</b>
PSR 100	25591	<b>213</b>	ROUNDA V2LED18W-WW-W	28935	<b>256</b>
QULES AC O-B	26306	<b>187</b>	ROUNDA V2LED24W-NW-SN	27220	<b>256</b>
QULES AC O-C/M	26304	<b>187</b>	ROUNDA V2LED24W-NW-W	28936	<b>256</b>
QULES AC O-W	26303	<b>187</b>	ROUNDA V2LED24W-WW-W	33524	<b>256</b>
RADAN CT-DSO50	7362	<b>181</b>	ROUNDA V2LED6W-NW-SN	27221	<b>256</b>
RADAN CT-DTOS0	7360	<b>181</b>	ROUNDA V2LED6W-NW-W	28937	<b>256</b>
RAIBO E27 B	36280	<b>150</b>	ROUNDA V2LED6W-WW-B	33562	<b>256</b>
RAIBO E27 BL	36282	<b>150</b>	ROUNDA V2LED6W-WW-W	28938	<b>256</b>
RAIBO E27 GN	36284	<b>150</b>	S A60 11,5WE27 RGB CCT	33642	<b>36</b>
RAIBO E27 PK	36285	<b>150</b>	S A60 7W E27 CCT	33640	<b>36</b>
RAIBO E27 W	36281	<b>150</b>	S A60 9W E27 RGB CCT	33641	<b>36</b>
RAIBO E27 Y	36283	<b>150</b>	S AD GN 10A PM	33701	<b>318</b>
RANGO MINI R7S SMD-WW	15099	<b>77</b>	S AD GN SCH 10A PM	33703	<b>318</b>
RANGO R7S SMD-WW	15098	<b>77</b>	S C37 4,9W E14 RGB CCT	33644	<b>36</b>
RAPID HI v2 E27-NW	22954	<b>49</b>	S GU10 4,7W RGB CCT	33643	<b>36</b>
RAPID HI v2 E27-WW	22955	<b>49</b>	S SENSOR ON\OFF INT	34942	<b>316</b>
RAPID MAXX v2 E27-NW	22948	<b>49</b>	S SENSOR PIR INT 10M	34940	<b>316</b>
RAPID MAXX v2 E27-WW	22949	<b>49</b>	S SENSOR W INT	34941	<b>317</b>
RAPID PRO v2 E27-NW	22946	<b>49</b>	S SWITCH G DOOR	34950	<b>319</b>
RAPID PRO v2 E27-WW	22947	<b>49</b>	S SWITCH ON\OFF	34948	<b>319</b>
RAPID v2 E27-NW	22944	<b>49</b>	S SWITCH SHUTTER	34949	<b>319</b>
RAPID v2 E27-WW	22945	<b>49</b>	SABIK LED AC-WW	23802	<b>198</b>
REF ATL1-18W-S15	33140	<b>305</b>	SABIK LED B-NW	29852	<b>198</b>
REF ATL1-18W-S36	33141	<b>305</b>	SABIK LED B-WW	29853	<b>198</b>
REF ATL1-30W-S15	33142	<b>305</b>	SABIK LED CW	23110	<b>198</b>
REF ATL1-30W-S36	33143	<b>305</b>	SABIK LED PIR B-NW	29858	<b>198</b>
REGIS 3 EVG 418 PT	19730	<b>216</b>	SABIK LED WW	23108	<b>198</b>
REGIS 3 OPAL 418 PT	19734	<b>216</b>	SABIK MINI LED B-NW	29854	<b>198</b>
REGIS 3WS EVG 418 PT	25710	<b>216</b>	SABIK MINI LED B-WW	29855	<b>198</b>
REGIS 3WS OPAL 418 PT	25713	<b>216</b>	SABIK MINI LED CW	23111	<b>198</b>
REGIS 4LED 418 PT	22673	<b>217</b>	SABIK MINI LED NW	32490	<b>198</b>
			SABIK MINI LED WW	23109	<b>198</b>

SANGA DL-100	8050	<b>246</b>	SHADE-U H-W 2m	26585	<b>93</b>
SANI IP44 DSO-B	29240	<b>107</b>	SIGO R39 LED E14-NW	22734	<b>76</b>
SANI IP44 DSO-SN	29242	<b>107</b>	SIGO R39 LED E14-WW	22733	<b>76</b>
SANI IP44 DSO-W	29241	<b>107</b>	SIGO R50 LED E14-NW	22736	<b>76</b>
SANSO LED 15W-NW-SE	26520	<b>243</b>	SIGO R50 LED E14-WW	22735	<b>76</b>
SEALINGS G	26602	<b>92</b>	SIGO R63 LED E27-NW	22738	<b>76</b>
SEIDY CT-DTL250-B/M	19459	<b>166</b>	SIGO R63 LED E27-WW	22737	<b>76</b>
SEIDY CT-DTL250-W/M	19455	<b>166</b>	SIMEN DSL B/G/B	29134	<b>168</b>
SEIDY CT-DTL50-AL	18281	<b>166</b>	SIMEN DSL B/W/B	29131	<b>168</b>
SEIDY CT-DTL50-B	18289	<b>166</b>	SIMEN DSL SR/B/B	29132	<b>168</b>
SEIDY CT-DTL50-B/M	19458	<b>166</b>	SIMEN DSL W/G/W	29135	<b>168</b>
SEIDY CT-DTL50-W/M	19454	<b>166</b>	SIMEN DSO B/G	29137	<b>168</b>
SEIDY CT-DTO50-AL	18280	<b>166</b>	SIMEN DSO B/W	29138	<b>168</b>
SEIDY CT-DTO50-B	18288	<b>166</b>	SIMEN DSO G/W	29142	<b>168</b>
SEIDY CT-DTO50-B/M	19457	<b>166</b>	SIMEN DSO W/B	29139	<b>168</b>
SEIDY CT-DTO50-W/M	19456	<b>166</b>	SIMEN DSO W/G	29140	<b>168</b>
SELTO 50 B	36556	<b>289</b>	SLICK JQ-L-B	8391	<b>325</b>
SELTO 80 B	36555	<b>289</b>	SLICK JQ-L-W	8390	<b>325</b>
SELTO EL 23 B	36557	<b>289</b>	SOLA LED AC-WW	23804	<b>199</b>
SEMPRA EL-II B-SR	33091	<b>134</b>	SOLA LED B-NW	27558	<b>199</b>
SEMPRA EL-II W-SR	33090	<b>134</b>	SOLA LED B-WW	27559	<b>199</b>
SEMPRA EL-2I B-SR	33093	<b>134</b>	SOLA LED NW	32491	<b>199</b>
SEMPRA EL-2I W-SR	33092	<b>134</b>	SOLA LED WW	23100	<b>199</b>
SEMPRA EL-3I B-SR	33095	<b>134</b>	SOLN LED 17,5W NW B/G	37324	<b>116</b>
SEMPRA EL-3I W-SR	33094	<b>134</b>	SONDA II EL-10 B	34920	<b>128</b>
SEMPRA EL-4I B-SR	33097	<b>134</b>	SONDA II EL-10 W	34921	<b>128</b>
SEMPRA EL-4I W-SR	33096	<b>134</b>	SONDA II EL-2I B	34922	<b>128</b>
SENSQUARE-B	37369	<b>324</b>	SONDA II EL-2I W	34923	<b>128</b>
SENSQUARE-W	37368	<b>324</b>	SONDA II EL-3I B	34924	<b>128</b>
SENTO	26820	<b>332</b>	SONDA II EL-3I W	34925	<b>128</b>
SENTO-O-WT-B	37367	<b>324</b>	SONDA II EL-30 B	34926	<b>128</b>
SENTO-O-WT-W	37366	<b>324</b>	SONDA II EL-30 W	34927	<b>128</b>
SENZO	26821	<b>332</b>	SONDA II EL-40 B	34928	<b>128</b>
SET105-K	1426	<b>336</b>	SONDA II EL-40 W	34929	<b>128</b>
SET60-K	1425	<b>336</b>	SONOR GU10 CO-B WW	24362	<b>107</b>
SHADE B/F-FR	26568	<b>88</b>	SOREN L-BL /LED	24414	<b>171</b>
SHADE B/F-FR	26568	<b>91</b>	SOREN L-SR CW /LED	24417	<b>171</b>
SHADE B/F-FR 2M	26570	<b>88</b>	SOREN L-SR WW /LED	24413	<b>171</b>
SHADE B/F-FR 2M	26570	<b>91</b>	SOREN O-BL /LED	24411	<b>171</b>
SHADE B/F-W	26569	<b>88</b>	SOREN O-SR CW /LED	24416	<b>171</b>
SHADE B/F-W	26569	<b>91</b>	SOREN O-SR WW /LED	24410	<b>171</b>
SHADE B/F-W 2M	26571	<b>88</b>	SPAG C B/G AWY	27324	<b>162</b>
SHADE B/F-W 2M	26571	<b>91</b>	SPAG D B/G AWY	27326	<b>162</b>
SHADE C/D/E/I-FR	26572	<b>89</b>	SPAG D W/G AWY	27327	<b>162</b>
SHADE C/D/E/I-FR	26572	<b>90</b>	SPAG S B/G AWY	27322	<b>162</b>
SHADE C/D/E/I-FR 2M	26573	<b>89</b>	SPN BRAVO S/P 12030	28505	<b>213</b>
SHADE C/D/E/I-FR 2M	26573	<b>90</b>	SPN BRAVO S/P 60-62	28504	<b>213</b>
SHADE C/D/E/I-W	26574	<b>89</b>	SPN PANEL 120	37336	<b>209</b>
SHADE C/D/E/I-W	26574	<b>90</b>	SPN PANEL 120	37336	<b>211</b>
SHADE C/D/E/I-W 2M	26575	<b>89</b>	SPN PANEL 60-62	37335	<b>209</b>
SHADE C/D/E/I-W 2M	26575	<b>90</b>	SPN PANEL 60-62	37335	<b>211</b>
SHADE CK C/D/E/I-FR	26576	<b>89</b>	SQMOTION-B	37361	<b>322</b>
SHADE CK C/D/E/I-FR	26576	<b>90</b>	SQMOTION-W	37360	<b>322</b>
SHADE CK C/D/E/I-FR2M	26577	<b>89</b>	ST 45 LED 0,5W E27-BL	26039	<b>50</b>
SHADE CK C/D/E/I-FR2M	26577	<b>90</b>	ST 45 LED 0,5W E27-GR	26048	<b>50</b>
SHADE CK C/D/E/I-W	26578	<b>89</b>	ST 45 LED 0,5W E27-NW	26046	<b>50</b>
SHADE CK C/D/E/I-W	26578	<b>90</b>	ST 45 LED 0,5W E27-RE	26049	<b>50</b>
SHADE CK C/D/E/I-W 2M	26579	<b>89</b>	ST 45 LED 0,5W E27-WW	26045	<b>50</b>
SHADE CK C/D/E/I-W 2M	26579	<b>90</b>	ST64 A 4W-SW	26047	<b>51</b>
SHADE CK G	26580	<b>92</b>	STAN GP	4864	<b>339</b>
SHADE CK G 2M	26581	<b>92</b>	STATO N LED 30W-B	29222	<b>267</b>
SHADE J/K-FR	26564	<b>94</b>	STATO N LED 50W-B	29223	<b>267</b>
SHADE J/K-FR	26564	<b>95</b>	STER TS-MF1	1001	<b>334</b>
SHADE J/K-FR 2m	26566	<b>94</b>	STIVI LED 24W-NW-O	35000	<b>236</b>
SHADE J/K-FR 2m	26566	<b>95</b>	STIVI LED 24W-NW-O-SE	35001	<b>236</b>
SHADE J/K-W	26565	<b>94</b>	STIVI LED 36W-NW-O	35002	<b>236</b>
SHADE J/K-W	26565	<b>95</b>	STIVI LED 36W-NW-O-SE	35003	<b>236</b>
SHADE J/K-W 2m	26567	<b>94</b>	STOBI DLP 250-B	26832	<b>110</b>
SHADE J/K-W 2m	26567	<b>95</b>	STOBI DLP 250-W	26833	<b>110</b>
SHADE-O H-W	26586	<b>93</b>	STOBI DLP 50-B	26830	<b>110</b>
SHADE-O H-W 2m	26587	<b>93</b>	STOBI DLP 50-W	26831	<b>110</b>
SHADE-U H-FR	26582	<b>93</b>	STONO 20 N	24654	<b>296</b>
SHADE-U H-FR 2m	26583	<b>93</b>	STONO 30	24651	<b>296</b>
SHADE-U H-W	26584	<b>93</b>	STONO 390 N	36591	<b>296</b>

STONO 490 N	36592	<b>296</b>	TEAR N CON-I FLEX W	33252	<b>310</b>
STONO 585 N	36593	<b>296</b>	TEAR N CON-I W	33240	<b>310</b>
STONO 780 N	36594	<b>296</b>	TEAR N CON-L LR-B	33245	<b>310</b>
STOPPER B	19181	<b>88</b>	TEAR N CON-L LR-W	33244	<b>310</b>
STOPPER C	19182	<b>89</b>	TEAR N CON-L RL-B	33243	<b>310</b>
STOPPER D	19183	<b>90</b>	TEAR N CON-L RL-W	33242	<b>310</b>
STOPPER F	26590	<b>91</b>	TEAR N CON-T LLR-B	33265	<b>310</b>
STOPPER G	26592	<b>92</b>	TEAR N CON-T LLR-W	33264	<b>310</b>
STOPPER J	26588	<b>94</b>	TEAR N CON-T LRR-B	33263	<b>310</b>
STOPPER J-W	26605	<b>94</b>	TEAR N CON-T LRR-W	33262	<b>310</b>
STOPPER K	26589	<b>95</b>	TEAR N CON-T RLL-B	33251	<b>310</b>
STOPPER K-W	26606	<b>95</b>	TEAR N CON-T RLL-W	33250	<b>310</b>
STOPPER-O H	26594	<b>93</b>	TEAR N CON-T RRL-B	33249	<b>310</b>
STOPPER-U H	26593	<b>93</b>	TEAR N CON-T RRL-W	33248	<b>310</b>
STRETON LED 100W NW	36231	<b>270</b>	TEAR N CON-X B	33247	<b>310</b>
STRETON LED 150W NW	36232	<b>270</b>	TEAR N CON-X W	33246	<b>311</b>
STRETON LED 200W NW	36233	<b>270</b>	TEAR N EPLUG B	33237	<b>311</b>
STRETON LED 20W NW	36228	<b>270</b>	TEAR N EPLUG W	33236	<b>311</b>
STRETON LED 40W NW	36229	<b>270</b>	TEAR N ICON-I B	33239	<b>311</b>
STRETON LED 60W NW	36230	<b>270</b>	TEAR N ICON-I W	33238	<b>311</b>
SUZI HR-60-B	7151	<b>153</b>	TEAR N PADAPTOR-B	33267	<b>313</b>
SUZI HR-60-BL	7152	<b>153</b>	TEAR N PADAPTOR-W	33266	<b>313</b>
SUZI HR-60-PK	7153	<b>153</b>	TEAR N PCON L-B	33261	<b>311</b>
SUZI HR-60-SR	7150	<b>153</b>	TEAR N PCON L-W	33260	<b>311</b>
SUZI HR-60-W	7154	<b>153</b>	TEAR N PCON R-B	33235	<b>311</b>
T-1\10-B	1257	<b>351</b>	TEAR N PCON R-W	33234	<b>311</b>
T-1\20-B	1271	<b>351</b>	TEAR N RC-CON-I B	35795	<b>311</b>
T-1\20-BL	1275	<b>351</b>	TEAR N RC-CON-I W	35794	<b>311</b>
T-1\20-GN	1274	<b>351</b>	TEAR N RC-CON-L B	35793	<b>312</b>
T-1\20-MIX	1283	<b>351</b>	TEAR N RC-CON-L W	35792	<b>311</b>
T-1\20-W	1276	<b>351</b>	TEAR N RC-CON-T B	35797	<b>312</b>
T5-13W 4000K/65	12716	<b>100</b>	TEAR N RC-CON-T W	35796	<b>312</b>
T5-14W 4000K/82	12717	<b>100</b>	TEAR N RC-CON-X B	35799	<b>312</b>
T5-8W 4000K/65	12715	<b>100</b>	TEAR N RC-CON-X W	35798	<b>312</b>
T8 18W/840 NW	19921	<b>101</b>	TEAR N RCLIP-B	35803	<b>312</b>
T8 18W/865 CW	19922	<b>101</b>	TEAR N RCLIP-W	35802	<b>312</b>
T8 36W/840 NW	19924	<b>101</b>	TEAR N RC-PCON B	35791	<b>311</b>
T8 36W/865 CW	19925	<b>101</b>	TEAR N RC-PCON W	35790	<b>311</b>
T8 LED GLASSv3 18W-CW	26065	<b>74</b>	TEAR N R-TR 2M-B	35801	<b>311</b>
T8 LED GLASSv3 18W-NW	26064	<b>74</b>	TEAR N R-TR 2M-W	35800	<b>311</b>
T8 LED GLASSv3 22W-CW	26059	<b>74</b>	TEAR N SCLAMP B	33255	<b>311</b>
T8 LED GLASSv3 22W-NW	26058	<b>74</b>	TEAR N SCLAMP W	33254	<b>311</b>
T8 LED GLASSv3 9W-CW	26063	<b>74</b>	TEAR N SKIT B	33257	<b>311</b>
T8 LED GLASSv3 9W-NW	26062	<b>74</b>	TEAR N SKIT W	33256	<b>311</b>
T8 LED GLASSv4 18W-CW	33213	<b>75</b>	TEAR N TR 1M-B	33231	<b>311</b>
T8 LED GLASSv4 18W-NW	33212	<b>75</b>	TEAR N TR 1M-W	33230	<b>311</b>
T8 LED GLASSv4 24W-CW	33215	<b>75</b>	TEAR N TR 2M-B	33233	<b>311</b>
T8 LED GLASSv4 24W-NW	33214	<b>75</b>	TEAR N TR 2M-W	33232	<b>311</b>
T8 LED GLASSv4 9W-CW	33211	<b>75</b>	TEDI MAXX LED GU 10-CW	23413	<b>69</b>
T8 LED GLASSv4 9W-NW	33210	<b>75</b>	TEDI MAXX LED GU 10-NW	23414	<b>69</b>
T8 LED GLASSv5 12W-CW	33217	<b>75</b>	TEDI MAXX LED GU 10-WW	23412	<b>69</b>
T8 LED GLASSv5 12W-NW	33216	<b>75</b>	TERRA LED AC-WW	23806	<b>197</b>
T8 LED STARTER	26069	<b>74</b>	TERRA LED B-NW	26848	<b>197</b>
T8LED GLASSv3T 18W NW	26068	<b>74</b>	TERRA LED B-WW	26849	<b>197</b>
TANO G4 SMD-NW	14937	<b>71</b>	TERRA LED CW	23104	<b>197</b>
TANO G4 SMD-WW	14936	<b>71</b>	TERRA LED PIR B-NW	29860	<b>197</b>
TAVO FRAME DL 12W	36522	<b>254</b>	TERRA LED PIR B-WW	29861	<b>197</b>
TAVO FRAME DL 18W	36523	<b>254</b>	TERRA LED W-CW	26843	<b>197</b>
TAVO FRAME DO 12W	36520	<b>254</b>	TERRA LED WW	23102	<b>197</b>
TAVO FRAME DO 18W	36521	<b>254</b>	TERRA LED W-WW	26842	<b>197</b>
TAVO LED DL 12W-NW	36517	<b>254</b>	TESON AL-DSL50	7373	<b>181</b>
TAVO LED DL 18W-NW	36518	<b>254</b>	TESON AL-DSO50	7372	<b>181</b>
TAVO LED DL 24W-NW	36519	<b>254</b>	TESON AL-DTL50	7371	<b>181</b>
TAVO LED DL 5W-NW	36515	<b>254</b>	TIBERI PRO 20W-940-B	35671	<b>250</b>
TAVO LED DL 9W-NW	36516	<b>254</b>	TIBERI PRO 20W-940-W	35670	<b>250</b>
TAVO LED DO 12W-NW	36512	<b>254</b>	TIBERI PRO 30W-940-B	35673	<b>250</b>
TAVO LED DO 18W-NW	36513	<b>254</b>	TIBERI PRO 30W-940-W	35672	<b>250</b>
TAVO LED DO 24W-NW	36514	<b>254</b>	TIBERI PRO 40W-940-B	35675	<b>250</b>
TAVO LED DO 5W-NW	36510	<b>254</b>	TIBERI PRO 40W-940-W	35674	<b>250</b>
TAVO LED DO 9W-NW	36511	<b>254</b>	TIBERI PRO NT20W-940B	35677	<b>251</b>
TAXI SMD L C/M-NW	26461	<b>279</b>	TIBERI PRO NT20W-940W	35676	<b>251</b>
TAXI SMD P C/M-NW	26463	<b>279</b>	TIBERI PRO NT30W-940B	35679	<b>251</b>
TEAR N CON-I B	33241	<b>310</b>	TIBERI PRO NT30W-940W	35678	<b>251</b>
TEAR N CON-I FLEX B	33253	<b>310</b>	TINY BORD DTO-B	37165	<b>164</b>

TINY BORD DTO-B/G	37166	<b>164</b>	VARSO LED 24W-NW-L-SE	26983	<b>234</b>
TINY BORD DTO-W	37167	<b>164</b>	VARSO LED 24W-NW-O	26445	<b>234</b>
TINY BORD DTO-W/G	37168	<b>164</b>	VARSO LED 24W-NW-O-SE	26984	<b>234</b>
TOMI LED5W MR16-CW	22705	<b>76</b>	VARSO LED 24W-WW-O	26444	<b>234</b>
TOMI LED5W MR16-WW	22704	<b>76</b>	VIDI CTC-5514-B	25995	<b>180</b>
TOMI LED7W MR16-CW	22707	<b>76</b>	VIDI CTC-5514-C	2791	<b>180</b>
TOMI LED7W MR16-WW	22706	<b>76</b>	VIDI CTC-5514-C/M	2793	<b>180</b>
TOMIv2 1,2W GU10-CW	34960	<b>68</b>	VIDI CTC-5514-W	2790	<b>180</b>
TOMIv2 1,2W GU10-NW	34961	<b>68</b>	VIDI CTC-5515-B	25996	<b>180</b>
TOMIv2 1,2W GU10-WW	34962	<b>68</b>	VIDI CTC-5515-C	2781	<b>180</b>
TOMIv2 2,9W GU10-CW	34963	<b>68</b>	VIDI CTC-5515-C/M	2783	<b>180</b>
TOMIv2 2,9W GU10-NW	34964	<b>68</b>	VIDI CTC-5515-W	2780	<b>180</b>
TOMIv2 2,9W GU10-WW	34965	<b>68</b>	VIMO 50 B	34984	<b>291</b>
TOMIv2 4,9W GU10-CW	34966	<b>68</b>	VIMO 50 BR	34985	<b>291</b>
TOMIv2 4,9W GU10-NW	34967	<b>68</b>	VIMO 50 SE-B	34986	<b>291</b>
TOMIv2 4,9W GU10-WW	34968	<b>68</b>	VIMO 50 SE-BR	34987	<b>291</b>
TOMIv2 6,5W GU10-CW	34969	<b>68</b>	VIMO 80 B	34988	<b>291</b>
TOMIv2 6,5W GU10-NW	34970	<b>68</b>	VIMO 80 BR	34989	<b>291</b>
TOMIv2 6,5W GU10-WW	34971	<b>68</b>	VIMO EL 27 B	34980	<b>291</b>
TONIL LED B	32520	<b>143</b>	VIMO EL 27 BR	34981	<b>291</b>
TONIL LED W	32521	<b>143</b>	VIMO EL 27 SE-B	34982	<b>291</b>
TP SLIM LED 40W-NW	27115	<b>221</b>	VIMO EL 27 SE-BR	34983	<b>291</b>
TP SLIM LED 50W-NW	27116	<b>221</b>	VORA EL 20 GR	36566	<b>299</b>
TP SLIM TW LED 40W-NW	27117	<b>221</b>	VORA SP 20 GR	36565	<b>299</b>
TP SLIM TW LED 50W-NW	27118	<b>221</b>	WIR ZL100	70961	<b>337</b>
TP STRONG LED 48W-NW	33170	<b>220</b>	WIR ZL120	70962	<b>337</b>
TP STRONG LED 75W-NW	33171	<b>220</b>	XARD DL-40	7195	<b>283</b>
TP STRONG LED 90W-NW ( )	33172	<b>220</b>	XLED A60 10W-NW	29606	<b>44</b>
TRIBIS II L AB	23843	<b>184</b>	XLED A60 10W-NW-M	29616	<b>46</b>
TRIBIS II L B	23853	<b>184</b>	XLED A60 10W-WW	29605	<b>44</b>
TRIBIS II L C	23844	<b>184</b>	XLED A60 10W-WW-M	29615	<b>46</b>
TRIBIS II L C/M	23845	<b>184</b>	XLED A60 4,5W-NW-M	29608	<b>46</b>
TRIBIS II L W	23849	<b>184</b>	XLED A60 4,5W-WW	29600	<b>44</b>
TRIBIS II O AB	23846	<b>184</b>	XLED A60 4,5W-WW-M	29607	<b>46</b>
TRIBIS II O B	23855	<b>184</b>	XLED A60 4W-SW	33516	<b>54</b>
TRIBIS II O C	23847	<b>184</b>	XLED A60 7W-CW	29603	<b>44</b>
TRIBIS II O C/M	23848	<b>184</b>	XLED A60 7W-NW	29602	<b>44</b>
TRIBIS II O W	23854	<b>184</b>	XLED A60 7W-NW-M	29610	<b>46</b>
TUNA MINI N	8091	<b>247</b>	XLED A60 7W-WW	29601	<b>44</b>
TUNA S1101-W	4260	<b>247</b>	XLED A60 7W-WW-M	29609	<b>46</b>
TURK DL-60	7025	<b>247</b>	XLED A60 8W-NW-M	29613	<b>46</b>
TURRO LED 3X15W-NW	18983	<b>280</b>	XLED A60 8W-WW	29604	<b>44</b>
TWISTER AOL100B	70926	<b>337</b>	XLED A60 8W-WW-M	29612	<b>46</b>
TWISTER AOL100T	70953	<b>337</b>	XLED A60 B22 10W-CW-M	33109	<b>48</b>
TWISTER AOL120B	70956	<b>337</b>	XLED A60 B22 10W-WW-M	33108	<b>48</b>
TWISTER AOL120T	70960	<b>337</b>	XLED A60 B22 7W-CW-M	33103	<b>48</b>
TYBIA LED 38W-NW	24640	<b>239</b>	XLED A60 B22 7W-WW	33100	<b>48</b>
TYBIA LED 38W-NW B	24642	<b>239</b>	XLED A60 B22 7W-WW-M	33102	<b>48</b>
TYBIA LED 38W-NW-SE	24641	<b>239</b>	XLED A60 M 7W-NW	33515	<b>52</b>
TYBIA LED 38W-NW-SE B	24643	<b>239</b>	XLED A60 M 7W-WW	33514	<b>52</b>
TYBIA M 25W-NW B	24645	<b>239</b>	XLED A70 18W-NW	29649	<b>45</b>
TYBIA M 25W-NW GY	24644	<b>239</b>	XLED A70 18W-WW	29648	<b>45</b>
TYBIA M 25W-NW-SE B	24647	<b>239</b>	XLED C35 E14 6W-NW	35273	<b>58</b>
TYBIA M 25W-NW-SE GY	24646	<b>239</b>	XLED C35 E14 6W-WW	35272	<b>58</b>
UCHW PODT OS S2 S3 IT	33830	<b>345</b>	XLED C35E14 2,5W-WW	29617	<b>58</b>
ULOV LED DIM WW W	37396	<b>140</b>	XLED C35E14 4,5W-NW	29619	<b>58</b>
USTI SP 1X7 GR	36561	<b>298</b>	XLED C35E14 4,5W-NW-M	29621	<b>58</b>
USTI SP 2X7 GR	36560	<b>298</b>	XLED C35E14 4,5W-WW	29618	<b>58</b>
VADRA 16L-UP	29010	<b>293</b>	XLED C35E14 4,5W-WW-M	29620	<b>58</b>
VADRA 21L-UP SE	29011	<b>293</b>	XLED C35E14 6W-NW-M	29623	<b>58</b>
VADRA 50	29012	<b>293</b>	XLED C35E14 6W-WW-M	29622	<b>58</b>
VADRA 80	29013	<b>293</b>	XLED C35E27 6W-NW-M	29647	<b>58</b>
VAND LED 17,5W NW B	37327	<b>117</b>	XLED C35E27 6W-WW-M	29646	<b>58</b>
VAND LED 17,5W NW W	37326	<b>117</b>	XLED C35T 2,5W-SW	29641	<b>54</b>
VARSO HI 36W-NW-L	26449	<b>234</b>	XLED EX A60 4W-NW	36244	<b>43</b>
VARSO HI 36W-NW-O	26448	<b>234</b>	XLED EX A60 4W-WW	36243	<b>43</b>
VARSO HI 36W-NW-O-SE	26985	<b>234</b>	XLED EX A60 5W-NW	36246	<b>43</b>
VARSO LED 18W-NW-L	26443	<b>234</b>	XLED EX A60 5W-WW	36245	<b>43</b>
VARSO LED 18W-NW-L-SE	26980	<b>234</b>	XLED EX A60 7,2W-NW	36248	<b>43</b>
VARSO LED 18W-NW-O	26441	<b>234</b>	XLED EX A60 7,2W-WW	36247	<b>43</b>
VARSO LED 18W-NW-O-SE	26981	<b>234</b>	XLED G125 11W-NW	33512	<b>53</b>
VARSO LED 18W-WW-O	26440	<b>234</b>	XLED G125 11W-WW	33511	<b>53</b>
VARSO LED 24W-NW-L	26447	<b>234</b>	XLED G125 4W-SW	33519	<b>54</b>

XLED G125 7W-WW	29638	<b>53</b>
XLED G45 E14 4,5W-WW	29624	<b>62</b>
XLED G45 E14 6W-NW	35277	<b>62</b>
XLED G45 E14 6W-NW-M	29629	<b>63</b>
XLED G45 E14 6W-WW	35276	<b>62</b>
XLED G45 E14 6W-WW-M	29628	<b>63</b>
XLED G45 E27 4,5W-WW	29625	<b>62</b>
XLED G45 E27 6W-NW	35275	<b>62</b>
XLED G45 E27 6W-NW-M	29633	<b>63</b>
XLED G45 E27 6W-WW	35274	<b>62</b>
XLED G45 E27 6W-WW-M	29632	<b>63</b>
XLED G45E14 4,5W-NW-M	29627	<b>63</b>
XLED G45E14 4,5W-WW-M	29626	<b>63</b>
XLED G45E27 4,5W-NW-M	29631	<b>63</b>
XLED G45E27 4,5W-WW-M	29630	<b>63</b>
XLED G95 4W-SW	33518	<b>54</b>
XLED G95 7W-WW	36241	<b>52</b>
XLED G95S 5,8W-NW	36242	<b>52</b>
XLED HP D46E40 38W-NW	37347	<b>98</b>
XLED HP D90E27 26W-NW	37346	<b>98</b>
XLED ST64 4W-SW	33517	<b>54</b>
XLED ST64 7W-WW	29637	<b>51</b>
XLED ST64C 7W-NW	33513	<b>51</b>
XLED W A60 8,5W-WW	37380	<b>55</b>
XLED W C35E14 4,5W-WW	37382	<b>55</b>
XLED W G45E14 4,5W-WW	37383	<b>55</b>
XLED W ST 64 7W-WW	37381	<b>55</b>
XLEDA60 7W-NW-STEPPDIM	29635	<b>47</b>
XLEDA60 7W-WW-STEPPDIM	29634	<b>47</b>
XLEDEX C35E14 3,8W-NW	37341	<b>57</b>
XLEDEX C35E14 3,8W-WW	37340	<b>57</b>
XLEDEX G45E14 3,8W-NW	37343	<b>61</b>
XLEDEX G45E14 3,8W-WW	37342	<b>61</b>
XLEDEX G45E27 3,8W-NW	37345	<b>61</b>
XLEDEX G45E27 3,8W-WW	37344	<b>61</b>
XLEDI M A60 B22 12W-CW	37244	<b>48</b>
XLEDI M A60 B22 12W-WW	37243	<b>48</b>
XLEDI M A60 E27 11W-CW	37242	<b>47</b>
XLEDI M A60 E27 11W-NW	37241	<b>47</b>
XLEDI M A60 E27 11W-WW	37240	<b>47</b>
XLEDIM C35E14 5,9W-WW	35278	<b>57</b>
ZARA HR-40-B	7561	<b>153</b>
ZARA HR-40-SR	7560	<b>153</b>
ZARA HR-40-W	7564	<b>153</b>
ZARK KRT \2-1	2180	<b>340</b>
ZARK KRW -3	2181	<b>340</b>
ZEPO LFD-T02/S-B	36632	<b>202</b>
ZEPO LFD-T02/S-C/M	4386	<b>202</b>
ZEPO LFD-T02/S-W	36633	<b>202</b>
ZEPO LFD-T02-B	36630	<b>202</b>
ZEPO LFD-T02-C/M	4381	<b>202</b>
ZEPO LFD-T02-W	36631	<b>202</b>
ZEST MON OS010 W	28974	<b>345</b>
ZEST MONT OS05	33871	<b>345</b>
ZEST MONT OS205	33877	<b>345</b>
ZEST MONT S20 FLAGA	33876	<b>345</b>
ZEST POD OR00 B	28985	<b>345</b>
ZEW EL-235J-B	22440	<b>276</b>
ZEW EL-235J-GR	22442	<b>276</b>
ZEW EL-235U-B	22441	<b>276</b>
ZEW EL-235U-GR	22443	<b>276</b>
ZONA FLAT-W	23452	<b>327</b>
ZONA JQ-37-B	463	<b>327</b>
ZONA JQ-37-W	464	<b>327</b>
ZONA MINI WT-W	37365	<b>323</b>
ZONA MINI-W	37364	<b>323</b>
ZUBI LED 4W E14-NW	24529	<b>70</b>
ZUBI LED 4W E14-WW	24528	<b>70</b>
ZUBI LED 4W G9-CW	24519	<b>70</b>
ZUBI LED 4W G9-NW	24527	<b>70</b>
ZUBI LED 4W G9-WW	24526	<b>70</b>



# INDEX NACH KANLUX CODE

## INDEX BY CODES

276	BERGAD-7L	282	7691	MERGEJQ-O	330
402	HLDR-G210	343	7870	ROPE-NT 150	218
405	HLDR-R7S	343	7870	ROPE-NT 150	219
460	ALERJQ-30-W	326	7871	ROPE-NT 150 SINGLE	218
461	ALERJQ-30-B	326	7871	ROPE-NT 150 SINGLE	219
463	ZONAJQ-37-B	327	7980	APO TM -3	340
464	ZONAJQ-37-W	327	8050	SANGA DL-100	246
810	GAVI CT-2116B-W	205	8091	TUNA MINI N	247
811	GAVI CT-2116B-C	205	8092	MILO 7040T/P-B	245
815	GAVI CT-2116B-C/M	205	8103	HAXA-DSO POWER LED-B	204
1001	STER TS-MF1	334	8121	OYO 5LED-CW	188
1016	CYBER TM -6	334	8220	HLDR-G9	342
1257	T-1\10-B	351	8390	SLICK JQ-L-W	325
1271	T-1\20-B	351	8391	SLICK JQ-L-B	325
1272	IT-1\20-Y	351	8490	J-80W 78MM STAR	100
1273	IT-1\20-RE	351	8491	J-120W 78MM STAR	100
1274	T-1\20-GN	351	8500	J-120W 118MM STAR	100
1275	T-1\20-BL	351	8810	PIRES DL-600	241
1276	T-1\20-W	351	8811	PIRES DL-600 NS	241
1277	IT-1\20-Y\GN	351	8820	ROLF JQ-L	329
1283	T-1\20-MIX	351	8821	ROLF JQ-O	330
1425	SET60-K	336	8822	ROLF MINI JQ-L	329
1426	SET105-K	336	8910	MARID JQ-L	328
1440	ADI 350 1x3W	335	8980	JURBA DL-2180	240
2160	HLDR-E27	341	8981	JURBA DL-218L	240
2161	HLDR-E27-F	342	10418	J-1000W 189MM	99
2162	HLDR-E27-D	342	12715	TS-8W 4000K/65	100
2170	HLDR-E14	341	12716	TS-13W 4000K/65	100
2173	HLDR-E14-F	341	12717	TS-14W 4000K/82	100
2180	ZARK KRT \2-1	340	14936	TANO G4 SMD-WW	71
2181	ZARK KRW -3	340	14937	TANO G4 SMD-NW	71
2186	PIN W\US	339	14977	LINUS LINK	204
2550	NAVI CTX-DT10-W	179	15098	RANGO R7S SMD-WW	77
2553	NAVI CTX-DT10-C/M	179	15099	RANGO MINI R7S SMD-WW	77
2580	LUTO CTX-DS02B-W	179	18120	FOGLER DL-2400	242
2583	LUTO CTX-DS02B-C/M	179	18121	FOGLER LED 14W-NW	242
2584	LUTO CTX-DS02B-AB	179	18192	GORDO N 1W CW-L-SR	281
2590	LUTO CTX-DT02B-W	179	18193	GORDO N 1W CW-O-SR	281
2591	LUTO CTX-DT02B-C	179	18194	MORO N IG-20	283
2780	VIDI CTC-5515-W	180	18280	SEIDY CT-DT050-AL	166
2781	VIDI CTC-5515-C	180	18281	SEIDY CT-DTL50-AL	166
2783	VIDI CTC-5515-C/M	180	18288	SEIDY CT-DT050-B	166
2790	VIDI CTC-5514-W	180	18289	SEIDY CT-DTL50-B	166
2791	VIDI CTC-5514-C	180	18420	G9-20W STAR	99
2793	VIDI CTC-5514-C/M	180	18421	G9-33W STAR	99
2824	HORN CTC-3114-GM/N	181	18422	G9-48W STAR	99
4260	TUNA S1101-W	247	18423	G9-60W STAR	99
4381	ZEPO LFD-T02-C/M	202	18502	LED12 G4-WW	71
4386	ZEPO LFD-T02/S-C/M	202	18503	LED12 G4-NW	71
4703	MARIN CT-S80-C	187	18510	MORTA CT-DSL50-B	173
4704	MARIN CT-S80-SN	187	18512	MORTA CT-DSL50-SR	173
4710	MARIN CT-S80-AB	187	18521	MAH PLUS-236-ABS/PC	225
4862	GRIP GP\S	339	18530	GWEN CT-DTL50-B	178
4863	GRIP W\US	339	18531	GWEN CT-DT050-B	178
4864	STAN GP	339	18560	EVIT CT-DTL50-AL	178
7015	MARC DL-60	243	18561	EVIT CT-DT050-AL	178
7025	TURK DL-60	247	18593	CL-MAH PLUS	225
7080	BART EL-235	277	18594	CL-MAH PLUS-INOX	225
7150	SUZI HR-60-SR	153	18983	TURRO LED 3X15W-NW	280
7151	SUZI HR-60-B	153	19000	PIRES ECO DL-250	241
7152	SUZI HR-60-BL	153	19001	PIRES ECO DL-250 NS	241
7153	SUZI HR-60-PK	153	19030	CONNECTOR 8	79
7154	SUZI HR-60-W	153	19032	CONNECTOR 8-CP	79
7172	BERG DL-100	282	19033	CONNECTOR 8-CPC	79
7173	BERG DL-10L	282	19036	CONNECTOR RGB 10-CP	85
7195	XARD DL-40	283	19037	CONNECTOR RGB 10-CPC	85
7280	ROGER DL-LED12	281	19038	CONNECTOR RGB 10	85
7281	ROGER DL-2LED6	281	19062	DABA N LED SMD DL-16W	238
7360	RADAN CT-DT050	181	19065	DABA PRO 25W NW-B	238
7362	RADAN CT-DS050	181	19066	DABA PRO 26W NW-SE-W	238
7371	TESON AL-DTL50	181	19161	PROFILO B	88
7372	TESON AL-DS050	181	19162	PROFILO C	89
7373	TESON AL-DSL50	181	19163	PROFILO D	90
7560	ZARA HR-40-SR	153	19181	STOPPER B	88
7561	ZARA HR-40-B	153	19182	STOPPER C	89
7564	ZARA HR-40-W	153	19183	STOPPER D	90
7690	MERGEJQ-L	328	19300	PIXA KT-40-W	152

19301	PIXA KT-40-B	152	22946	RAPID PRO v2 E27-NW	49
19440	MORTA CT-DSO50-B	173	22947	RAPID PRO v2 E27-WW	49
19442	MORTA CT-DSO50-SR	173	22948	RAPID MAXX v2 E27-NW	49
19454	SEIDY CT-DTL50-W/M	166	22949	RAPID MAXX v2 E27-WW	49
19455	SEIDY CT-DTL250-W/M	166	22954	RAPID HI v2 E27-NW	49
19456	SEIDY CT-DTO50-W/M	166	22955	RAPID HI v2 E27-WW	49
19457	SEIDY CT-DTO50-B/M	166	23100	SOLA LED WW	199
19458	SEIDY CT-DTL50-B/M	166	23102	TERRA LED WW	197
19459	SEIDY CT-DTL250-B/M	166	23104	TERRA LED CW	197
19730	REGIS 3 EVG 418 PT	216	23106	APUS LED WW	196
19731	NOTUS 3 EVG 418 NT	218	23107	APUS LED CW	196
19732	NOTUS 3 EVG 236 NT	218	23108	SABIK LED WW	198
19733	NOTUS 3 EVG 218 NT	218	23109	SABIK MINI LED WW	198
19734	REGIS 3 OPAL 418 PT	216	23110	SABIK LED CW	198
19736	REGIS 4LED OPAL 418PT	217	23111	SABIK MINI LED CW	198
19761	GAVI LED18 SMD-WW-C/M	205	23120	JASMIN 270-WE	122
19921	T8 18W/840 NW	101	23121	JASMIN 370-WE	122
19922	T8 18W/865 CW	101	23122	JASMIN 470-WE	122
19924	T8 36W/840 NW	101	23123	JASMIN 270-W	122
19925	T8 36W/865 CW	101	23124	JASMIN 370-W	122
22110	MORTA B CT-DSL50-B	174	23125	JASMIN 470-W	122
22112	MORTA B CT-DSL50-SR	174	23126	JASMIN 270-W/M	122
22116	MORTA B CT-DSO50-B	174	23127	JASMIN 370-W/M	122
22117	MORTA B CT-DSO50-SR	174	23128	JASMIN 470-W/M	122
22140	CONTROLLER LED RGB-RF	85	23412	TEDI MAXX LED GU 10-WW	69
22144	REMOTE MONO	87	23413	TEDI MAXX LED GU 10-CW	69
22145	REMOTE CCT	87	23414	TEDI MAXX LED GU 10-NW	69
22146	REMOTE RGBW	87	23418	BILO 4,9W E27-NW	64
22147	CTR L 12/24V MONO/CTT	87	23419	BILO 4,9W E27-WW	64
22148	CTR L 12/24V RG BW CTT	87	23428	BILO 4,9W E14-NW	64
22340	FRANCO 15LED SMD KT-W	155	23429	BILO 4,9W E14-WW	64
22341	FRANCO 15LED SMD KT-B	155	23434	DUN 4,9W E14-WW	59
22371	AZ-10A	333	23435	DUN 4,9W E14-NW	59
22422	ESG LED 9W GX53-WW	77	23436	DUN 6,5W E14-NW	59
22423	ESG LED 9W GX53-NW	77	23437	DUN 6,5W E14-WW	59
22424	ESG LED 9W GX53-CW	77	23438	IDO 6,5W E14-NW	59
22430	DALLA CT-DTO50-W	171	23439	IDO 6,5W E14-WW	59
22431	DALLA CT-DTL50-W	171	23450	ALER MINI-W	326
22432	DALLA CT-DTO50-B	171	23451	MERGE ADJ-O	331
22433	DALLA CT-DTL50-B	171	23452	ZONA FLAT-W	327
22440	ZEW EL-235J-B	276	23453	MERGE MW-L	331
22441	ZEW EL-235U-B	276	23520	IMBER LED NW	188
22442	ZEW EL-235J-GR	276	23521	IMBER LED CW	188
22443	ZEW EL-235U-GR	276	23522	IMBER LED WW	188
22551	BORD DLP-50-W	111	23756	JASMIN WE-W	121
22552	BORD DLP-50-B	111	23757	JASMIN W-W	121
22603	MAH-LED N 20W-NW/PC	223	23758	JASMIN W/M-W	121
22604	MAH-LED N 40W-NW/PC	223	23800	APUS LED AC-WW	196
22605	MAH-LED N 50W-NW/PC	223	23801	APUS LED AC-CW	196
22606	MAH LED HI 19W-NW RYF	222	23802	SABIK LED AC-WW	198
22607	MAH LED HI 38W-NW RYF	222	23804	SOLA LED AC-WW	199
22608	MAH LED HI 48W-NW RYF	222	23806	TERRA LED AC-WW	197
22609	MAH LED HI 26W-NW RYF	222	23843	TRIBIS II LAB	184
22671	NOTUS 4LED 418 NT	219	23844	TRIBIS II L C	184
22672	NOTUS 4LED 236 NT	219	23845	TRIBIS II L C/M	184
22673	REGIS 4LED 418 PT	217	23846	TRIBIS II O AB	184
22674	NOTUS 4LED 218 NT	219	23847	TRIBIS II O C	184
22704	TOMI LED5W MR16-WW	76	23848	TRIBIS II O C/M	184
22705	TOMI LED5W MR16-CW	76	23849	TRIBIS II L W	184
22706	TOMI LED7W MR16-WW	76	23853	TRIBIS II L B	184
22707	TOMI LED7W MR16-CW	76	23854	TRIBIS II O W	184
22733	SIGO R39 LED E14-WW	76	23855	TRIBIS II O B	184
22734	SIGO R39 LED E14-NW	76	23860	DRIVE LED 0-15W 12VDC	336
22735	SIGO R50 LED E14-WW	76	24240	CIRCO LED 12VDC 0-10W	336
22736	SIGO R50 LED E14-NW	76	24241	CIRCO LED 12VDC 0-15W	336
22737	SIGO R63 LED E27-WW	76	24362	SONOR GU10 CO-B WW	107
22738	SIGO R63 LED E27-NW	76	24410	SOREN O-SR WW /LED	171
22800	MAH PLUS-236/4LED/PC	224	24411	SOREN O-BL /LED	171
22801	MAH PLUS-258/4LED/PC	224	24413	SOREN L-SR WW /LED	171
22802	MAH PLUS-136/4LED/PC	224	24414	SOREN L-BL /LED	171
22803	MAH PLUS-158/4LED/PC	224	24416	SOREN O-SR CW /LED	171
22841	HIMA LED 23W-NW-W	248	24417	SOREN L-SR CW /LED	171
22842	HIMA LED 23W-NW-B	248	24513	LEDS-B 4 8W/M IP65-WW	79
22843	HIMA LED 33W-NW-W	248	24514	LEDS-B 4 8W/M IP65-NW	79
22844	HIMA LED 33W-NW-B	248	24515	LEDS-B 4 8W/M IP65-CW	79
22944	RAPID v2 E27-NW	49	24516	LEDS-B 4 8W/M IP00-WW	79
22945	RAPID v2 E27-WW	49	24517	LEDS-B 4 8W/M IP00-NW	79

24518	LEDS-B 4 8W/M IP00-CW	79	26540	PROFILO B 2m	88
24519	ZUBI LED 4W G9-CW	70	26541	PROFILO C 2m	89
24526	ZUBI LED 4W G9-WW	70	26542	PROFILO D 2m	90
24527	ZUBI LED 4W G9-NW	70	26544	PROFILO J	94
24528	ZUBI LED 4W E14-WW	70	26545	PROFILO J 2M	94
24529	ZUBI LED 4W E14-NW	70	26546	PROFILO J-W	94
24530	LEDS-B 7 2W/M IP00RGB	85	26547	PROFILO J-W 2M	94
24531	LEDS-B 7 2W/M IP65RGB	85	26548	PROFILO K	95
24532	LEDS-B 7 2W/M IP54RGB	85	26549	PROFILO K 2m	95
24640	TYBIA LED 38W-NW	239	26550	PROFILO K-W	95
24641	TYBIA LED 38W-NW-SE	239	26551	PROFILO K-W 2m	95
24642	TYBIA LED 38W-NW B	239	26552	PROFILO F	91
24643	TYBIA LED 38W-NW-SE B	239	26553	PROFILO F 2m	91
24644	TYBIA M 25W-NW GY	239	26558	PROFILO G	92
24645	TYBIA M 25W-NW B	239	26559	PROFILO G 2m	92
24646	TYBIA M 25W-NW-SE GY	239	26560	PROFILO H	93
24647	TYBIA M 25W-NW-SE B	239	26561	PROFILO H 2m	93
24651	STONO 30	296	26562	CONNECT-L C	89
24654	STONO 20 N	296	26563	CONNECT C/D/E/I	89
25476	GORD XS DLP 50-B	112	26563	CONNECT C/D/E/I	90
25477	GORD XS DLP 50-W	112	26564	SHADE J/K-FR	94
25478	BORD XS DLP-50-B	112	26564	SHADE J/K-FR	95
25479	BORD XS DLP-50-W	112	26565	SHADE J/K-W	94
25591	PSR 100	213	26565	SHADE J/K-W	95
25690	PLAFMIN O	244	26566	SHADE J/K-FR 2m	94
25710	REGIS 3WS EVG 418 PT	216	26566	SHADE J/K-FR 2m	95
25711	NOTUS 3WS EVG 418 NT	218	26567	SHADE J/K-W 2m	94
25712	NOTUS 3WS EVG 236 NT	218	26567	SHADE J/K-W 2m	95
25713	REGIS 3WS OPAL 418 PT	216	26568	SHADE B/F-FR	88
25720	AKVEN LED	300	26568	SHADE B/F-FR	91
25780	IVIAN LED 4,5W W-WW	253	26569	SHADE B/F-W	88
25781	IVIAN LED 4,5W SN-WW	253	26569	SHADE B/F-W	91
25782	IVIAN LED 4,5W W-NW	253	26570	SHADE B/F-FR 2M	88
25783	IVIAN LED 4,5W SN-NW	253	26570	SHADE B/F-FR 2M	91
25990	NAVI CTX-DS10-B	179	26571	SHADE B/F-W 2M	88
25991	NAVI CTX-DT10-B	179	26571	SHADE B/F-W 2M	91
25995	VIDI CTC-5514-B	180	26572	SHADE C/D/E/I-FR	89
25996	VIDI CTC-5515-B	180	26572	SHADE C/D/E/I-FR	90
26039	ST 45 LED 0,5W E27-BL	50	26573	SHADE C/D/E/I-FR 2M	89
26045	ST 45 LED 0,5W E27-WW	50	26573	SHADE C/D/E/I-FR 2M	90
26046	ST 45 LED 0,5W E27-NW	50	26574	SHADE C/D/E/I-W	89
26047	ST64 A 4W-SW	51	26574	SHADE C/D/E/I-W	90
26048	ST 45 LED 0,5W E27-GR	50	26575	SHADE C/D/E/I-W 2M	89
26049	ST 45 LED 0,5W E27-RE	50	26575	SHADE C/D/E/I-W 2M	90
26058	T8 LED GLASSv3 22W-NW	74	26576	SHADE CK C/D/E/I-FR	89
26059	T8 LED GLASSv3 22W-CW	74	26576	SHADE CK C/D/E/I-FR	90
26062	T8 LED GLASSv3 9W-NW	74	26577	SHADE CK C/D/E/I-FR2M	89
26063	T8 LED GLASSv3 9W-CW	74	26577	SHADE CK C/D/E/I-FR2M	90
26064	T8 LED GLASSv3 18W-NW	74	26578	SHADE CK C/D/E/I-W	89
26065	T8 LED GLASSv3 18W-CW	74	26578	SHADE CK C/D/E/I-W	90
26068	T8LED GLASSv3T 18W NW	74	26579	SHADE CK C/D/E/I-W 2M	89
26069	T8 LED STARTER	74	26579	SHADE CK C/D/E/I-W 2M	90
26303	QULES AC O-W	187	26580	SHADE CK G	92
26304	QULES AC O-C/M	187	26581	SHADE CK G 2M	92
26306	QULES AC O-B	187	26582	SHADE-U H-FR	93
26326	COB SET 3m DIM-WW	86	26583	SHADE-U H-FR 2m	93
26327	COB SET 3m DIM-NW	86	26584	SHADE-U H-W	93
26360	ALDO 4LED 1X60	228	26585	SHADE-U H-W 2m	93
26361	ALDO 4LED 1X120	228	26586	SHADE-O H-W	93
26362	ALDO 4LED 1X150	228	26587	SHADE-O H-W 2m	93
26364	ALDO 4LED 2X120	228	26588	STOPPER J	94
26365	ALDO 4LED 2X150	228	26589	STOPPER K	95
26440	VARSO LED 18W-WW-O	234	26590	STOPPER F	91
26441	VARSO LED 18W-NW-O	234	26592	STOPPER G	92
26443	VARSO LED 18W-NW-L	234	26593	STOPPER-U H	93
26444	VARSO LED 24W-WW-O	234	26594	STOPPER-O H	93
26445	VARSO LED 24W-NW-O	234	26595	HANDLE J/K	94
26447	VARSO LED 24W-NW-L	234	26595	HANDLE J/K	95
26448	VARSO HI 36W-NW-O	234	26596	HANDLE B/F	88
26449	VARSO HI 36W-NW-L	234	26596	HANDLE B/F	91
26461	TAXI SMD L C/M-NW	279	26597	HANDLE C/D/E/I	89
26463	TAXI SMD P C/M-NW	279	26597	HANDLE C/D/E/I	90
26520	SANSO LED 15W-NW-SE	243	26598	HANDLE G	92
26536	APUS LED AC B-NW	196	26599	HANDLE H	93
26537	APUS LED AC B-WW	196	26600	HANDLE SIDE H	93
26538	APUS LED B-NW	196	26602	SEALINGS G	92
26539	APUS LED B-WW	196	26604	CONNECT-L B	88

26605	STOPPER J-W	94	27115	TP SLIM LED 40W-NW	221
26606	STOPPER K-W	95	27116	TP SLIM LED 50W-NW	221
26680	ASTEN LED IP44 8W-NW	190	27117	TP SLIM TW LED 40W-NW	221
26681	ASTEN LED IP44 12W-NW	190	27118	TP SLIM TW LED 50W-NW	221
26682	ASTEN LED IP44 15W-NW	190	27155	HB PRO LED HI 100W-NW	272
26683	ASTEN IP44 8W-NW-B	190	27156	HB PRO LED HI 150W-NW	272
26684	ASTEN IP44 12W-NW-B	190	27157	HB PRO LED HI 200W-NW	272
26685	ASTEN IP44 15W-NW-B	190	27212	KANTI V2LED 12W-NW-SN	261
26686	ASTEN IP44 8W-NW-W	190	27213	KANTI V2LED 18W-NW-SN	261
26687	ASTEN IP44 12W-NW-W	190	27216	KATRO V2LED 24W-NW-SN	258
26688	ASTEN IP44 15W-NW-W	190	27220	ROUNDA V2LED24W-NW-SN	256
26700	ROLSO LED IP44 15W-NW	189	27221	ROUNDA V2LED6W-NW-SN	256
26714	MORTA OCT-SR	174	27318	IQ-LED ES-111 12W-WW	72
26715	MORTA OCT-B	174	27319	IQ-LED ES-111 12W-NW	72
26716	MORTA CT-DT050-SR	173	27322	SPAG S B/G AWY	162
26717	MORTA CT-DT050-B	173	27324	SPAG C B/G AWY	162
26718	MORTA CT-DTL50-SR	173	27326	SPAG D B/G AWY	162
26719	MORTA CT-DTL50-B	173	27327	SPAG D W/G AWY	162
26720	ARET 1XMR16-W	175	27370	APUS LED PIR WW	196
26723	ARET 2XMR16-W	175	27378	APUS LED W-NW	196
26726	ALOR DSL-W	169	27379	APUS LED PIR NW	196
26727	ALOR DSL-B	169	27482	PICTO ONTEC G D5	349
26731	ALOR DTL-W	169	27483	PICTO ONTEC G D2	349
26732	ALOR DTL-B	169	27484	PICTO ONTEC G D3	349
26736	IVRI DTO-W	175	27485	PICTO ONTEC G D8	349
26738	APRILA DTO-W	165	27488	PICTO ONTEC G D7	349
26740	COLIE DTO-W	177	27490	PICTO ONTEC G W1	349
26741	COLIE DTO-G	177	27497	PICTO ONTEC G F1	349
26743	COLIE DTO-B	177	27498	PICTO ONTEC G F2	349
26744	COLIE DTO-GR	177	27499	PICTO ONTEC G DB	349
26747	NESTA DSL-C	177	27500	PICTO ONTEC G DC	349
26748	NESTA DSL-C/M	177	27505	PICTO ONTEC S D5	350
26751	NESTA DTL-C	177	27506	PICTO ONTEC S D2	350
26752	NESTA DTL-C/M	177	27507	PICTO ONTEC S D3	350
26753	ALREN DTL-W	176	27508	PICTO ONTEC S D8	350
26754	ALREN DTL-B	176	27509	PICTO ONTEC S D1	350
26756	ALREN DTL-C/M	176	27510	PICTO ONTEC S D6	350
26757	ALREN R DTL-B	176	27511	PICTO ONTEC S D7	350
26758	ALREN R DTL-W	176	27512	PICTO ONTEC S D4	350
26766	BILO 6,5W E14-NW	64	27513	PICTO ONTEC S W1	350
26767	BILO 6,5W E14-WW	64	27514	PICTO ONTEC S W2	350
26768	BILO 6,5W E27-NW	64	27520	PICTO ONTEC S F1	350
26769	BILO 6,5W E27-WW	64	27522	PICTO ONTEC S DB	350
26770	AVAR 6060 40W-NW	214	27523	PICTO ONTEC S DC	350
26771	AVAR 6060 40W-CW	214	27527	ONTEC S M1180MSTW	344
26773	AVAR 6262 40W-NW	214	27528	ONTEC S 20M1X ST W	344
26774	AVAR 6262 40W-WW	214	27529	ONTEC S 20M1X AT W	344
26790	ALOR DSO-W	169	27558	SOLA LED B-NW	199
26791	ALOR DSO-B	169	27559	SOLA LED B-WW	199
26795	ALOR DTO-W	169	27567	RITI GU10 B/B	111
26796	ALOR DTO-B	169	27569	RITI GU10 W/W	111
26810	POWELED P 12V 30W	335	27570	RITI GU10 W/G	111
26811	POWELED P 12V 60W	335	27571	RITI GU10 B/G	111
26815	POWELED P 24V 30W	335	27575	MINI RITI GU10 B/G	163
26816	POWELED P 24V 60W	335	27576	MINI RITI GU10 W/G	163
26820	SENTO	332	27577	MINI RITI GU10 B/W	163
26821	SENZO	332	27578	MINI RITI GU10 B/B	163
26830	STOBI DLP 50-B	110	27579	MINI RITI GU10 W/W	163
26831	STOBI DLP 50-W	110	27590	LINUS LED 4W-NW	204
26832	STOBI DLP 250-B	110	27591	LINUS LED 7W-NW	204
26833	STOBI DLP 250-W	110	27602	HERON II LED B	152
26840	APUS LED W-WW	196	27603	HERON II LED W	152
26841	APUS LED W-CW	196	27610	ADTR 6060 SR	209
26842	TERRA LED W-WW	197	27610	ADTR 6060 SR	213
26843	TERRA LED W-CW	197	27611	ADTR 12030 W	209
26848	TERRA LED B-NW	197	27611	ADTR 12030 W	213
26849	TERRA LED B-WW	197	27612	ADTR 12030 SR	209
26961	MEBA 4LED 2X120 PS	227	27612	ADTR 12030 SR	213
26964	MEBA 4LED 2X120 OP PS	227	27613	ADTR 6060 W	209
26965	MEBA 4LED 2X150 OP PS	227	27613	ADTR 6060 W	213
26980	VARSO LED 18W-NW-L-SE	234	27614	ADTR 12030 B	209
26981	VARSO LED 18W-NW-O-SE	234	27614	ADTR 12030 B	213
26983	VARSO LED 24W-NW-L-SE	234	27615	ADTR 6060 B	209
26984	VARSO LED 24W-NW-O-SE	234	27615	ADTR 6060 B	213
26985	VARSO HI 36W-NW-O-SE	234	27616	ADTR-S 6060 W	209
27000	ETISSA D20 GR	106	27617	ADTR-S-H 6060 W	209
27001	OGIVA D35 GR	106	27652	ONTECS C1302MATW	344

# INDEX NACH KANLUX CODE

## INDEX BY CODES

27769	ITECH M1 60 NM ST W	346	29001	GORI EL 235 D	292
27800	ELNIS S W	170	29002	GORI 50	292
27804	ELNIS L W	170	29003	GORI 80	292
27805	ELNIS L W/A	170	29010	VADRA 16L-UP	293
27806	ELNIS L W/C	170	29011	VADRA 21L-UP SE	293
27808	ELNIS L A/C	170	29012	VADRA 50	293
27809	ELNIS L A	170	29013	VADRA 80	293
27810	ELNIS L B/G	170	29031	IMINES DSO-W	165
28002	BRAVO PU36W6060NW W	212	29098	ONTEC R M1 60N M STW	348
28010	BRAVO S 40W6060NW W	212	29110	MILENO EL-10 B-AG	138
28022	BRAVO S 40W12030NW W	212	29111	MILENO EL-10 ASR-AN	138
28025	BRAVO DRIVER 36W	212	29112	MILENO EL-30 B-AG	138
28026	BRAVO DRIVER 40W	212	29113	MILENO EL-30 ASR-AN	138
28029	BRAVO DRIVER 28W	212	29114	MILENO EL-21 B-AG	138
28500	BRAVO S/P GRIP 60-62	213	29115	MILENO EL-21 ASR-AN	138
28501	BRAVO S/P GRIP 12030	213	29116	MILENO EL-31 B-AG	138
28502	CLIPS BRAVO S/P 60-62	213	29117	MILENO EL-31 ASR-AN	138
28503	CLIPS BRAVO S/P 12030	213	29118	MILENO EL-41 B-AG	138
28504	SPN BRAVO S/P 60-62	213	29119	MILENO EL-41 ASR-AN	138
28505	SPN BRAVO S/P 12030	213	29120	LAURIN EL-10 W	132
28508	BRAVO DALI SET 36W	212	29121	LAURIN EL-10 B	132
28512	AVAR DALI SET 40W	214	29122	LAURIN EL-21 W	132
28515	BLINGO DALI SET 38W	211	29123	LAURIN EL-21 B	132
28515	BLINGO DALI SET 38W	211	29124	LAURIN EL-31 W	132
28551	BRAVO PU28W3060NW W	212	29125	LAURIN EL-31 B	132
28760	ENALI EL-10 W	136	29126	LAURIN EL-30 W	132
28761	ENALI EL-10 B	136	29127	LAURIN EL-30 B	132
28762	ENALI EL-21 W	136	29128	LAURIN EL-40 W	132
28763	ENALI EL-21 B	136	29129	LAURIN EL-40 B	132
28764	ENALI EL-30 W	136	29131	SIMEN DSL B/W/B	168
28765	ENALI EL-30 B	136	29132	SIMEN DSL SR/B/B	168
28766	ENALI EL-31 W	136	29134	SIMEN DSL B/G/B	168
28767	ENALI EL-31 B	136	29135	SIMEN DSL W/G/W	168
28768	ENALI EL-41 W	136	29137	SIMEN DSO B/G	168
28769	ENALI EL-41 B	136	29138	SIMEN DSO B/W	168
28780	MINI GORD DLP-50-W	163	29139	SIMEN DSO W/B	168
28781	MINI GORD DLP-50-B	163	29140	SIMEN DSO W/G	168
28782	MINI BORD DLP-50-W	164	29142	SIMEN DSO G/W	168
28783	MINI BORD DLP-50-B	164	29160	ORTE LED 18W-NW-O	237
28930	ROUND A V2LED12W-NW-SR	256	29161	ORTE LED 24W-NW-O	237
28931	ROUND A V2LED12W-NW-W	256	29162	ORTE LED 18W-NW-O-SE	237
28932	ROUND A V2LED12W-WW-W	256	29163	ORTE LED 24W-NW-O-SE	237
28933	ROUND A V2LED18W-NW-SR	256	29170	INVO OP EL-53-L-GR	294
28934	ROUND A V2LED18W-NW-W	256	29171	INVO OP 47-L-GR	294
28935	ROUND A V2LED18W-WW-W	256	29172	INVO OP 77-L-GR	294
28936	ROUND A V2LED24W-NW-W	256	29173	INVO OP 107-L-GR	294
28937	ROUND A V2LED6W-NW-W	256	29174	INVO TR EL-53-O-GR	295
28938	ROUND A V2LED6W-WW-W	256	29175	INVO TR 47-O-GR	295
28939	KATRO V2LED 12W-NW-SR	258	29176	INVO TR 77-O-GR	295
28940	KATRO V2LED 12W-NW-W	258	29177	INVO TR 107-O-GR	295
28941	KATRO V2LED 12W-WW-W	258	29205	JASMIN 470-B	122
28942	KATRO V2LED 18W-NW-SR	258	29207	JASMIN 270-B	122
28943	KATRO V2LED 18W-NW-W	258	29208	JASMIN 370-B	122
28945	KATRO V2LED 24W-NW-W	258	29209	JASMIN B-W	121
28946	KATRO V2LED 6W-NW-W	258	29210	MERA LED 5W NW	203
28948	CARSA V2LED 12W-NW-W	260	29211	MERA LED 10W NW	203
28949	CARSA V2LED 18W-NW-W	260	29212	MERA LED 15W NW	203
28950	KANTI V2LED 12W-NW-W	261	29213	MERA LED 20W NW	203
28951	KANTI V2LED 18W-NW-W	261	29214	MERA LED PP	203
28961	POWELED P 12V 100W	335	29222	STATO N LED 30W-B	267
28962	POWELED P 24V 100W	335	29223	STATO N LED 50W-B	267
28963	POWELED P 12V 150W	335	29231	GOVIK DSO-W/G	160
28964	POWELED P 24V 150W	335	29232	GOVIK DSO-B/G	160
28965	POWELED P 12V 200W	335	29233	GOVIK-ST DSO-W/G	160
28966	POWELED P 24V 200W	335	29234	GOVIK-ST DSO-B/G	160
28973	ONTEC S M1180MATW	344	29235	GOVIK DSO-W A	160
28974	ZEST MON OS010 W	345	29236	GOVIK DSO-B A	160
28976	ONTEC G E1E 301 M STW	347	29237	GOVIK-ST DSO-B	160
28977	ONTEC S C1302MATWCLD	344	29238	GOVIK-ST DSO-W	160
28978	ONTEC S C160NMATW	344	29240	SANI IP44 DSO-B	107
28979	ONTEC G E1E180MATW	347	29241	SANI IP44 DSO-W	107
28985	ZEST POD OR00 B	345	29242	SANI IP44 DSO-SN	107
28990	REKA LED EL 7W-L-GR	274	29260	BISO LED EL 8W-GR	275
28991	REKA LED EL 7W-O-GR	274	29261	BISO LED EL 8W-W	275
28992	REKA LED EL 7W-L-W	274	29270	GARTO LED EL 8W-GR	275
28993	REKA LED EL 7W-O-W	274	29271	GARTO LED EL 8W-W	275
29000	GORI EL 135 D	292	29300	MODv2 LED 12W-WW	78

29301	MODv2 LED 12W-NW	78	32495	MEFIS LED W-NW	200
29302	MODv2 LED 19W-WW	78	32497	MEFIS LED B-NW	200
29303	MODv2 LED 19W-NW	78	32500	MARIN CT-S80-W	187
29310	CHIRO GU10 DTO-W	162	32501	MARIN CT-S80-B	187
29311	CHIRO GU10 DTO-B	162	32520	TONIL LED B	143
29313	CHIRO GU10 DTL-B	162	32521	TONIL LED W	143
29580	AREL LED DO 6W-NW	252	32930	MATEO ES DLP-150-B	253
29581	AREL LED DO 6W-WW	252	32931	MATEO ES DLP-150-W	253
29582	AREL LED DL 6W-NW	252	32932	MATEO ES DLP-250-B	253
29584	AREL LED DO 10W-NW	252	32933	MATEO ES DLP-250-W	253
29585	AREL LED DO 10W-WW	252	32940	BENO 18W NW-O-W	233
29586	AREL LED DL 10W-NW	252	32942	BENO 18W NW-L-W	233
29588	AREL LED DO 14W-NW	252	32944	BENO 18W NW-O-SE W	233
29589	AREL LED DO 14W-WW	252	32946	BENO 18W NW-L-SE W	233
29590	AREL LED DL 14W-NW	252	32948	BENO N 18W NW-O-SE GR	233
29600	XLED A60 4,5W-WW	44	32949	BENO N 18W NW-L-SE GR	233
29601	XLED A60 7W-WW	44	32952	BLURRO 2xGU10 CO-B	113
29602	XLED A60 7W-NW	44	32953	BLURRO 2xGU10 CO-W	113
29603	XLED A60 7W-CW	44	33070	REXAR LED W	155
29604	XLED A60 8W-WW	44	33071	REXAR LED B	155
29605	XLED A60 10W-WW	44	33080	REMI LED GU 10-NW	69
29606	XLED A60 10W-NW	44	33081	REMI LED GU 10-WW	69
29607	XLED A60 4,5W-WW-M	46	33082	REMI LED GU 10-CW	69
29608	XLED A60 4,5W-NW-M	46	33090	SEMPRA EL-11 W-SR	134
29609	XLED A60 7W-WW-M	46	33091	SEMPRA EL-11 B-SR	134
29610	XLED A60 7W-NW-M	46	33092	SEMPRA EL-21 W-SR	134
29612	XLED A60 8W-WW-M	46	33093	SEMPRA EL-21 B-SR	134
29613	XLED A60 8W-NW-M	46	33094	SEMPRA EL-31 W-SR	134
29615	XLED A60 10W-WW-M	46	33095	SEMPRA EL-31 B-SR	134
29616	XLED A60 10W-NW-M	46	33096	SEMPRA EL-41 W-SR	134
29617	XLED C35E14 2,5W-WW	58	33097	SEMPRA EL-41 B-SR	134
29618	XLED C35E14 4,5W-WW	58	33100	XLED A60 B22 7W-WW	48
29619	XLED C35E14 4,5W-NW	58	33102	XLED A60 B22 7W-WW-M	48
29620	XLED C35E14 4,5W-WW-M	58	33103	XLED A60 B22 7W-CW-M	48
29621	XLED C35E14 4,5W-NW-M	58	33108	XLED A60 B22 10W-WW-M	48
29622	XLED C35E14 6W-WW-M	58	33109	XLED A60 B22 10W-CW-M	48
29623	XLED C35E14 6W-NW-M	58	33120	FLINI IP44 DSL-B	186
29624	XLED G45 E14 4,5W-WW	62	33121	FLINI IP44 DSL-W	186
29625	XLED G45 E27 4,5W-WW	62	33122	FLINI IP44 DSO-B	186
29626	XLED G45E14 4,5W-WW-M	63	33123	FLINI IP44 DSO-W	186
29627	XLED G45E14 4,5W-NW-M	63	33125	DROXY IP65 DSO-W	186
29628	XLED G45 E14 6W-WW-M	63	33126	DROXY IP65 DSO-B	186
29629	XLED G45 E14 6W-NW-M	63	33130	ATL1 18W-930-S6-W	304
29630	XLED G45E27 4,5W-WW-M	63	33131	ATL1 18W-930-S6-B	304
29631	XLED G45E27 4,5W-NW-M	63	33132	ATL1 18W-940-S6-W	304
29632	XLED G45 E27 6W-WW-M	63	33133	ATL1 18W-940-S6-B	304
29633	XLED G45 E27 6W-NW-M	63	33134	ATL1 30W-930-S6-W	304
29634	XLEDA60 7W-WW-STEPDIM	47	33135	ATL1 30W-930-S6-B	304
29635	XLEDA60 7W-NW-STEPDIM	47	33136	ATL1 30W-940-S6-W	304
29637	XLED ST64 7W-WW	51	33137	ATL1 30W-940-S6-B	304
29638	XLED G125 7W-WW	53	33138	ATL2 GU10-W	306
29641	XLED C35T 2,5W-SW	54	33139	ATL2 GU10-B	306
29646	XLED C35E27 6W-WW-M	58	33140	REF ATL1-18W-S15	305
29647	XLED C35E27 6W-NW-M	58	33141	REF ATL1-18W-S36	305
29648	XLED A70 18W-WW	45	33142	REF ATL1-30W-S15	305
29649	XLED A70 18W-NW	45	33143	REF ATL1-30W-S36	305
29832	LART EL-160-GR	277	33144	ATL3 GU10-B	306
29833	LART EL-260-GR	277	33145	ATL3 GU10-W	306
29840	ADTR 3060 W	213	33146	ATL4 GU10-B	307
29841	ADTR 3060 SR	213	33147	ATL4 GU10-W	307
29842	ADTR 3060 B	213	33148	ATL5 GU10-B	307
29843	ADTR-H 6060 W	209	33149	ATL5 GU10-W	307
29843	ADTR-H 6060 W	211	33165	AGEO DSO-B	165
29844	ADTR-H 6060 SR	209	33166	AGEO DSO-W	165
29845	ADTR-H 6060 B	209	33170	TP STRONG LED 48W-NW	220
29852	SABIK LED B-NW	198	33171	TP STRONG LED 75W-NW	220
29853	SABIK LED B-WW	198	33172	TP STRONG LED 90W-NW ( )	220
29854	SABIK MINI LED B-NW	198	33177	BLINGO TN38W 6060 NW	208
29855	SABIK MINI LED B-WW	198	33178	BLINGO TN24-28W6060NW	208
29856	APUS LED PIR B-NW	196	33179	BLINGO TUN48W 6060 NW	208
29857	APUS LED PIR B-WW	196	33188	BLINGO PU 36W 6262 NW	208
29858	SABIK LED PIR B-NW	198	33190	HBPH LENS 50D 100W	273
29860	TERRA LED PIR B-NW	197	33191	HBPH LENS 50D 150W	273
29861	TERRA LED PIR B-WW	197	33192	HBPH LENS 50D 200W	273
32488	APUS LED NW	196	33193	HBPH LENS 120D 100W	273
32490	SABIK MINI LED NW	198	33194	HBPH LENS 120D 150W	273
32491	SOLA LED NW	199	33195	HBPH LENS 120D 200W	273

# INDEX NACH KANLUX CODE

## INDEX BY CODES

33196	HBPH GRID 100W	273	33325	ERINUS LED LL W-NW	194
33197	HBPH GRID 150W	273	33327	ERINUS LED L GR-NW	194
33198	HBPH GRID 200W	273	33329	ERINUS LED O GR-NW	194
33200	ANTEM LED 10W-NW B	266	33330	ERINUS LED LL GR-WW	194
33201	ANTEM LED 20W-NW B	266	33331	ERINUS LED LL GR-NW	194
33202	ANTEM LED 30W-NW B	266	33332	ERINUS LED L B-WW	194
33203	ANTEM LED 50W-NW B	266	33333	ERINUS LED L B-NW	194
33204	ANTEM LED 100W-NW B	266	33334	ERINUS LED O B-WW	194
33205	ANTEM LED 10W-NW-SE B	266	33335	ERINUS LED O B-NW	194
33206	ANTEM LED 20W-NW-SE B	266	33336	ERINUS LED LL B-WW	194
33207	ANTEM LED 30W-NW-SE B	266	33337	ERINUS LED LL B-NW	194
33208	ANTEM LED 50W-NW-SE B	266	33340	BENO 24W NW-O-W	233
33210	T8 LED GLASSv4 9W-NW	75	33341	BENO 24W NW-O-GR	233
33211	T8 LED GLASSv4 9W-CW	75	33342	BENO 24W NW-L-W	233
33212	T8 LED GLASSv4 18W-NW	75	33343	BENO 24W NW-L-GR	233
33213	T8 LED GLASSv4 18W-CW	75	33344	BENO 24W NW-O-SE W	233
33214	T8 LED GLASSv4 24W-NW	75	33345	BENO 24W NW-O-SE GR	233
33215	T8 LED GLASSv4 24W-CW	75	33346	BENO 24W NW-L-SE W	233
33216	T8 LED GLASSv5 12W-NW	75	33347	BENO 24W NW-L-SE GR	233
33217	T8 LED GLASSv5 12W-CW	75	33351	LCO B 10W/M 24 IP00-WW	84
33230	TEAR N TR 1M-W	311	33352	LCO B 10W/M 24 IP65-WW	84
33231	TEAR N TR 1M-B	311	33353	LCO B 10W/M 24 IP00-CW	84
33232	TEAR N TR 2M-W	311	33354	LCO B 10W/M 24 IP65-CW	84
33233	TEAR N TR 2M-B	311	33355	L120B 16W/M 24IP00-WW	81
33234	TEAR N PCON R-W	311	33356	L120B 16W/M 24IP00-NW	81
33235	TEAR N PCON R-B	311	33360	AQILO IP65 DSO-W	108
33236	TEAR N EPLUG W	311	33361	AQILO IP65 DSO-B	108
33237	TEAR N EPLUG B	311	33362	AQILO IP65 DSO-GR	108
33238	TEAR N ICON-I W	311	33364	LCOB 8W/M 12 IP00-WW	83
33239	TEAR N ICON-I B	311	33365	LCOB 8W/M 12 IP65-WW	83
33240	TEAR N CON-I W	310	33366	LCOB 8W/M 12 IP00-NW	83
33241	TEAR N CON-I B	310	33367	LCOB 8W/M 12 IP65-NW	83
33242	TEAR N CON-L RL-W	310	33368	"	84
33243	TEAR N CON-L RL-B	310	33369	LCOB 10W/M 24 IP65-WW	84
33244	TEAR N CON-L LR-W	310	33390	ADTR-H 12030 W	209
33245	TEAR N CON-L LR-B	310	33390	ADTR-H 12030 W	211
33246	TEAR N CON-X W	311	33391	ADTR-H 12030 B	209
33247	TEAR N CON-X B	310	33392	ADTR-H 12030 SR	209
33248	TEAR N CON-T RRL-W	310	33393	ADTR-H 3060 W	211
33249	TEAR N CON-T RRL-B	310	33398	ADTR-H 76MM 6060 W	209
33250	TEAR N CON-T RLL-W	310	33435	ADTR-H 6262 W	209
33251	TEAR N CON-T RLL-B	310	33470	FL AGOR LED 100W NW	262
33252	TEAR N CON-I FLEX W	310	33471	FL AGOR LED 150W NW	262
33253	TEAR N CON-I FLEX B	310	33472	FL AGOR LED 200W NW	262
33254	TEAR N SCLAMP W	311	33473	FL AGOR/A LED 100W	262
33255	TEAR N SCLAMP B	311	33474	FL AGOR/A LED 150W	262
33256	TEAR N SKIT W	311	33475	FL AGOR/A LED 200W	262
33257	TEAR N SKIT B	311	33476	FL AGOR HI 240W NW	263
33260	TEAR N PCON L-W	311	33477	FL AGOR/A HI 240W NW	263
33261	TEAR N PCON L-B	311	33478	FL AGOR HI 300W NW	263
33262	TEAR N CON-T LRR-W	310	33479	FL AGOR/A HI 300W NW	263
33263	TEAR N CON-T LRR-B	310	33482	FL AGOR HI GRID 240W	263
33264	TEAR N CON-T LLR-W	310	33483	FL AGOR HI GRID 300W	263
33265	TEAR N CON-T LLR-B	310	33511	XLED G125 11W-WW	53
33266	TEAR N PADAPTOR-W	313	33512	XLED G125 11W-NW	53
33267	TEAR N PADAPTOR-B	313	33513	XLED ST64C 7W-NW	51
33302	L60 11W/M 12 IP00-WW	80	33514	XLED A60 M 7W-WW	52
33303	L60 11W/M 12 IP00-NW	80	33515	XLED A60 M 7W-NW	52
33304	L60 11W/M 12 IP00-CW	80	33516	XLED A60 4W-SW	54
33305	L60B 11W/M 12 IP00-WW	80	33517	XLED ST64 4W-SW	54
33306	L60B 11W/M 12 IP00-NW	80	33518	XLED G95 4W-SW	54
33307	L60B 11W/M 12 IP00-CW	80	33519	XLED G125 4W-SW	54
33308	L60 11W/M 12 IP65-WW	80	33524	ROUND A V2LED24W-WW-W	256
33309	L60 11W/M 12 IP65-NW	80	33541	CARSA V2LED 24W-NW-W	260
33310	L60 11W/M 12 IP65-CW	80	33562	ROUND A V2LED6W-WW-B	256
33311	L120 16W/M 24 IP00-WW	81	33640	S A60 7W E27 CCT	36
33312	L120 16W/M 24 IP00-NW	81	33641	S A60 9W E27 RGB CCT	36
33314	L120 16W/M 24 IP65-WW	81	33642	S A60 11,5WE27 RGB CCT	36
33315	L120 16W/M 24 IP65-NW	81	33643	S GU10 4,7W RGB CCT	36
33317	L120 16W/M 12 IP00 CCT	82	33644	S C37 4,9W E14 RGB CCT	36
33318	L48 9W/M 24 IP00-RGBW	86	33651	AREL FRAME DO 14W W	252
33319	L48 9W/M 24 IP65-RGBW	86	33670	GALOBA EL-10 W	130
33320	ERINUS LED L W-WW	194	33671	GALOBA EL-10 B	130
33321	ERINUS LED L W-NW	194	33672	GALOBA W 1xGU10 W	143
33322	ERINUS LED O W-WW	194	33673	GALOBA W 1xGU10 B	143
33323	ERINUS LED O W-NW	194	33674	GALOBA EL-21 W	130
33324	ERINUS LED LL W-WW	194	33675	GALOBA EL-21 B	130

33676	GALOBA EL-3I W	130	33881	IQ-LED FL-20W-NW	264
33677	GALOBA EL-3I B	130	33882	IQ-LED FL-30W-NW	264
33678	GALOBA EL-40 W	130	33883	IQ-LED FL-50W-NW	264
33679	GALOBA EL-40 B	130	33884	IQ-LED FL-90W-NW	264
33680	GALOBA EL-4I W	130	33885	IQ-LED FL-10W-NW-SE	264
33681	GALOBA EL-4I B	130	33886	IQ-LED FL-20W-NW-SE	264
33690	GLASI LED 3W P WW-W	279	33887	IQ-LED FL-30W-NW-SE	264
33691	GLASI LED 3W P WW-B	279	33888	IQ-LED FL-50W-NW-SE	264
33692	GLASI LED 3W P WW-GR	279	33889	IQ-LED FL QC I 3x1MM2	264
33693	GLASI LED 3W P NW-W	279	33890	MEBA LED 12-20W NW/WW	227
33694	GLASI LED 3W P NW-B	279	33891	MEBA LED 22-40W NW/WW	227
33695	GLASI LED 3W P NW-GR	279	33892	MEBA LED 20W IP54 NW	226
33701	S AD GN 10A PM	318	33893	MEBA LED 40W IP54 NW	226
33703	S AD GN SCH 10A PM	318	33894	MEBA 4LED 60 IP54 PC	226
33722	IQ-LEDDIM A60 7,3W-WW	42	33895	MEBA 4LED 120 IP54 PC	226
33723	IQ-LEDDIM A60 7,3W-NW	42	33896	MEBA 4LED 150 IP54 PC	226
33724	IQ-LEDDIM A6010,5W-WW	42	34475	NEDIA E14 B	151
33725	IQ-LEDDIM A6010,5W-NW	42	34476	NEDIA E14 W	151
33726	IQ-LEDDIM A6013,6W-WW	42	34920	SONDA II EL-10 B	128
33727	IQ-LEDDIM A6013,6W-NW	42	34921	SONDA II EL-10 W	128
33746	IQ-LED A67 N 19W-WW	41	34922	SONDA II EL-2I B	128
33747	IQ-LED A67 N 19W-NW	41	34923	SONDA II EL-2I W	128
33748	IQ-LED A67 N 19W-CW	41	34924	SONDA II EL-3I B	128
33750	DULI LED 4W-NW-L-GR	278	34925	SONDA II EL-3I W	128
33751	DULI LED 4W-NW-O-GR	278	34926	SONDA II EL-30 B	128
33752	DULI LED 6,5W-NW-L-GR	278	34927	SONDA II EL-30 W	128
33753	DULI LED 6,5W-NW-O-GR	278	34928	SONDA II EL-40 B	128
33760	IQ-LED Life G45 4,2W-WW	38	34929	SONDA II EL-40 W	128
33761	IQ-LED Life G45 4,2W-NW	38	34930	ASTIM IP44 8W-NW-B	189
33762	IQ-LED Life A60 7,2W-WW	38	34931	ASTIM IP44 8W-NW-W	189
33763	IQ-LED Life A60 7,2W-NW	38	34932	ASTIM IP44 8W-NW-C	189
33764	IQ-LED Life GU10 4,8W-WW	38	34933	ASTIM IP44 12W-NW-B	189
33765	IQ-LED Life GU10 4,8W-NW	38	34934	ASTIM IP44 12W-NW-W	189
33769	IQ-LEDEX GU 10 2,5W-NW	65	34935	ASTIM IP44 12W-NW-C	189
33810	ONTEC S W1302MATWCLD	344	34940	S SENSOR PIR INT 10M	316
33812	ITECH M2 302MATW	346	34941	S SENSOR W INT	317
33814	ITECH M5 305MATW	346	34942	S SENSOR ON/OFF INT	316
33815	ITECH C1 302MATW	346	34948	S SWITCH ON/OFF	319
33818	ONTEC S M2302MATWCLD	344	34949	S SWITCH SHUTTER	319
33819	ONTEC S M2102MATWCLD	344	34950	S SWITCH G DOOR	319
33821	ITECH M2 302MSTW	346	34960	TOMiv2 1,2W GU10-CW	68
33822	ITECH M5 105MSTW	346	34961	TOMiv2 1,2W GU10-NW	68
33823	ITECH C1 302 STW	346	34962	TOMiv2 1,2W GU10-WW	68
33824	ITECH F2 105MSTW	346	34963	TOMiv2 2,9W GU10-CW	68
33826	ONTEC R C1 60N M STW	348	34964	TOMiv2 2,9W GU10-NW	68
33829	OPRAWA DWUSTRONNA OSO	345	34965	TOMiv2 2,9W GU10-WW	68
33830	UCHW PODT OS S2 S3 IT	345	34966	TOMiv2 4,9W GU10-CW	68
33832	ITECH M5 105MATW	346	34967	TOMiv2 4,9W GU10-NW	68
33833	ITECH S1 302MATW	346	34968	TOMiv2 4,9W GU10-WW	68
33834	ITECH C2 105MATW	346	34969	TOMiv2 6,5W GU10-CW	68
33835	ITECH F1 302MATW	346	34970	TOMiv2 6,5W GU10-NW	68
33836	ITECH F2 105MATW	346	34971	TOMiv2 6,5W GU10-WW	68
33837	ITECH W2 105MATW	346	34980	VIMO EL 27 B	291
33840	ONTEC S M5105MATW	344	34981	VIMO EL 27 BR	291
33841	ONTEC S M5305MATW	344	34982	VIMO EL 27 SE-B	291
33842	ONTEC S C1302MATW	344	34983	VIMO EL 27 SE-BR	291
33843	ONTEC S C2105MATW	344	34984	VIMO 50 B	291
33844	ONTEC S F2105MATW	344	34985	VIMO 50 BR	291
33845	ONTEC S W1302MATW	344	34986	VIMO 50 SE-B	291
33846	ONTEC S W2105MATWCLD	344	34987	VIMO 50 SE-BR	291
33847	ONTEC C M160NMATW	347	34988	VIMO 80 B	291
33849	ONTEC C C160NMATW	347	34989	VIMO 80 BR	291
33850	ONTEC R M1 60N M ATW	348	35000	STIVI LED 24W-NW-O	236
33851	ONTEC R M2 302 M ATW	348	35001	STIVI LED 24W-NW-O-SE	236
33852	ONTEC R M2 302 M ATW	348	35002	STIVI LED 36W-NW-O	236
33855	ONTEC S M5105MSTW	344	35003	STIVI LED 36W-NW-O-SE	236
33856	ONTEC S M2302MSTWCLD	344	35240	IQ-LED GU10 6,5W-WW	66
33858	ONTEC C M160NMSTW	347	35241	IQ-LED GU10 6,5W-NW	66
33862	ONTEC S C1302MSTW	344	35242	IQ-LED GU10 6,5W-CW	66
33864	ONTEC S F2105MSTW	344	35243	IQ-LED GU10 6,5WS3-WW	66
33865	ONTEC S W1302MSTW	344	35244	IQ-LED GU10 6,5WS3-NW	66
33866	ONTEC S W1302MSTWCLD	344	35245	IQ-LED GU10 6,5WS3-CW	66
33868	ONTEC C C160NMSTW	347	35246	IQ-LEDDIM GU10 7W-WW	67
33871	ZEST MONT OS05	345	35247	IQ-LEDDIM GU10 7W-NW	67
33876	ZEST MONT S20 FLAGA	345	35248	IQ-LEDDIM GU10 7W-CW	67
33877	ZEST MONT OS205	345	35252	IQ-LED AR-111 13W-WW	72
33880	IQ-LED FL-10W-NW	264	35253	IQ-LED AR-111 13W-NW	72



# INDEX NACH KANLUX CODE

## INDEX BY CODES

35254	IQ-LED EX T8 12W-NW	73	35780	PREDA LED B	154
35255	IQ-LED EX T8 12W-CW	73	35781	PREDA LED W	154
35256	IQ-LED GU 10 4,9W-WW	65	35785	EVALO TL GU10 W-SR	148
35257	IQ-LED GU 10 4,9W-NW	65	35786	EVALO TL GU10 B-SR	148
35258	IQ-LED GU 10 4,9W-CW	65	35787	EVALO FL 3xGU10 W-SR	149
35272	XLED C35 E14 6W-WW	58	35788	EVALO FL 3xGU10 B-SR	149
35273	XLED C35 E14 6W-NW	58	35790	TEAR N RC-PCON W	311
35274	XLED G45 E27 6W-WW	62	35791	TEAR N RC-PCON B	311
35275	XLED G45 E27 6W-NW	62	35792	TEAR N RC-CON-L W	311
35276	XLED G45 E14 6W-WW	62	35793	TEAR N RC-CON-L B	312
35277	XLED G45 E14 6W-NW	62	35794	TEAR N RC-CON-I W	311
35278	XLEDIM C35E14 5,9W-WW	57	35795	TEAR N RC-CON-I B	311
35280	ELICEO DSO B/B	172	35796	TEAR N RC-CON-T W	312
35281	ELICEO DSO W/W	172	35797	TEAR N RC-CON-T B	312
35283	ELICEO DSO W/G	172	35798	TEAR N RC-CON-X W	312
35284	ELICEO-ST DSO B/B	172	35799	TEAR N RC-CON-X B	312
35285	ELICEO-ST DSO W/W	172	35800	TEAR N R-TR 2M-W	311
35287	ELICEO-ST DSO W/G	172	35801	TEAR N R-TR 2M-B	311
35288	ELICEO DSO W	172	35802	TEAR N RCLIP-W	312
35289	ELICEO DSO B	172	35803	TEAR N RCLIP-B	312
35295	ELICEO DSO YG	172	36210	GLOZO DSL W/W	157
35296	ELICEO DSO GR	172	36211	GLOZO DSL B/W	157
35297	ELICEO DSO PK	172	36212	GLOZO DSL G/W	157
35298	ELICEO DSO BL	172	36213	GLOZO DSL SR/W	157
35508	RIFA LED 17,5W NW N2	118	36214	GLOZO DSL W/B	157
35509	RIFA LED 17,5W WW N2	118	36215	GLOZO DSL B/B	157
35640	DERATO EL-10 B-SR	124	36216	GLOZO DSL G/B	157
35641	DERATO EL-10 W-SR	124	36217	GLOZO DSL SR/B	157
35642	DERATO EL-21 B-SR	124	36218	GLOZO DSO W/W	156
35643	DERATO EL-21 W-SR	124	36219	GLOZO DSO B/W	156
35644	DERATO EL-30 B-SR	124	36220	GLOZO DSO G/W	156
35645	DERATO EL-30 W-SR	124	36221	GLOZO DSO SR/W	156
35646	DERATO EL-41 B-SR	124	36222	GLOZO DSO W/B	156
35647	DERATO EL-41 W-SR	124	36223	GLOZO DSO B/B	156
35650	BTL 18W-930-W	308	36224	GLOZO DSO G/B	156
35651	BTL 18W-930-B	308	36225	GLOZO DSO SR/B	156
35652	BTL 18W-940-W	308	36228	STRETON LED 20W NW	270
35653	BTL 18W-940-B	308	36229	STRETON LED 40W NW	270
35654	BTL 28W-930-W	308	36230	STRETON LED 60W NW	270
35655	BTL 28W-930-B	308	36231	STRETON LED 100W NW	270
35656	BTL 28W-940-W	308	36232	STRETON LED 150W NW	270
35657	BTL 28W-940-B	308	36233	STRETON LED 200W NW	270
35658	BTL 38W-930-W	308	36241	XLED G95 7W-WW	52
35659	BTL 38W-930-B	308	36242	XLED G95S 5,8W-NW	52
35660	BTL 38W-940-W	308	36243	XLED EX A60 4W-WW	43
35661	BTL 38W-940-B	308	36244	XLED EX A60 4W-NW	43
35662	BT LW 18W-930-W	309	36245	XLED EX A60 5W-WW	43
35663	BT LW 18W-930-B	309	36246	XLED EX A60 5W-NW	43
35664	BT LW 18W-940-W	309	36247	XLED EX A60 7,2W-WW	43
35665	BT LW 18W-940-B	309	36248	XLED EX A60 7,2W-NW	43
35670	TIBERI PRO 20W-940-W	250	36250	AGZAR E14 B	144
35671	TIBERI PRO 20W-940-B	250	36251	AGZAR E14 W	144
35672	TIBERI PRO 30W-940-W	250	36252	AGZAR C 3xE14 B	104
35673	TIBERI PRO 30W-940-B	250	36253	AGZAR C 3xE14 W	104
35674	TIBERI PRO 40W-940-W	250	36254	AGZAR EL-10 B	144
35675	TIBERI PRO 40W-940-B	250	36255	AGZAR EL-10 W	144
35676	TIBERI PRO NT20W-940W	251	36260	LARATA E27 W	145
35677	TIBERI PRO NT20W-940B	251	36261	LARATA E27 B	145
35678	TIBERI PRO NT30W-940W	251	36262	LARATA EL-10 W	145
35679	TIBERI PRO NT30W-940B	251	36263	LARATA EL-10 B	145
35688	EVALO EL-51 W-SR	126	36270	JUSI E27 W	151
35689	EVALO EL-51 B-SR	126	36271	JUSI E27 B	151
35690	EVALO EL-11 W-SR	126	36280	RAIBO E27 B	150
35691	EVALO EL-11 B-SR	126	36281	RAIBO E27 W	150
35692	EVALO EL-21 W-SR	126	36282	RAIBO E27 BL	150
35693	EVALO EL-21 B-SR	126	36283	RAIBO E27 Y	150
35694	EVALO EL-31 W-SR	126	36284	RAIBO E27 GN	150
35695	EVALO EL-31 B-SR	126	36285	RAIBO E27 PK	150
35696	EVALO EL-40 W-SR	126	36320	INITA LED IP54 GN	147
35697	EVALO EL-40 B-SR	126	36321	INITA LED IP54 B	147
35698	EVALO EL-41 W-SR	126	36322	INITA LED IP54 R	147
35699	EVALO EL-41 B-SR	126	36323	INITA LED IP54 Y	147
35750	GRL 6M5E27-B	301	36324	INITA LED IP54 W	147
35754	GRL 11M10E27-B	301	36331	K LED GU10 6W-NW	67
35758	GRL 15M15E27-B	301	36332	K LED GU10 6W-CW	67
35770	ERTON 140 OP-W	244	36333	K LED N GU10 6W-WW	67
35771	ERTON 240 OP-W	244	36381	ONTEC S M2302MSTW	344

36382	ONTEC S M2302MATW	344	36631	ZEPO LFD-T02-W	202
36430	BERG AD-70	282	36632	ZEPO LFD-T02/S-B	202
36432	GRIBLO 7 GR	300	36633	ZEPO LFD-T02/S-W	202
36440	JASMIN 270-G/O	122	36640	AQILO E14 IP65 D50-GR	108
36441	JASMIN 370-G/O	122	36641	AQILO E14 IP65 D50-W	108
36442	JASMIN 470-G/O	122	36642	AQILO E14 IP65 D50-B	108
36443	JASMIN G/O-W	121	36643	AQILO E27 IP65 D50-GR	108
36460	RIFA LED 17,5W NW W/W	118	36644	AQILO E27 IP65 D50-W	108
36461	RIFA LED 17,5W WW W/W	118	36645	AQILO E27 IP65 D50-B	108
36462	RIFA LED 17,5W NW B/W	118	36650	AKVO IP44 15W-NW-W S	192
36463	RIFA LED 17,5W WW B/W	118	36651	AKVO IP44 15W-NW-B S	192
36464	RIFA LED 17,5W NW B/G	118	36652	AKVO IP44 15W-NW-C S	192
36465	RIFA LED 17,5W WW B/G	118	36653	AKVO IP44 20W-NW-W S	192
36466	RIFA LED 17,5W NW GR/G	118	36654	AKVO IP44 20W-NW-B S	192
36467	RIFA LED 17,5W WW GR/G	118	36655	AKVO IP44 20W-NW-C S	192
36468	RIFA LED 17,5W NW N1	118	36656	AKVO IP44 23W-NW-W S	192
36469	RIFA LED 17,5W WW N1	118	36657	AKVO IP44 23W-NW-B S	192
36499	JASMIN C 270-G/O	105	36658	AKVO IP44 23W-NW-C S	192
36500	JASMIN C 370-G/O	105	36659	AKVO IP44 15W-NW-W	193
36501	JASMIN C 470-G/O	105	36660	AKVO IP44 15W-NW-B	193
36502	JASMIN C 270-W/M	105	36661	AKVO IP44 15W-NW-C	193
36503	JASMIN C 370-W/M	105	36662	AKVO IP44 20W-NW-W	193
36504	JASMIN C 470-W/M	105	36663	AKVO IP44 20W-NW-B	193
36505	JASMIN C 270-B	105	36664	AKVO IP44 20W-NW-C	193
36506	JASMIN C 370-B	105	36665	AKVO IP44 23W-NW-W	193
36507	JASMIN C 470-B	105	36666	AKVO IP44 23W-NW-B	193
36510	TAVO LED DO 5W-NW	254	36667	AKVO IP44 23W-NW-C	193
36511	TAVO LED DO 9W-NW	254	36670	IQ-LED A60 3,4W-WW	40
36512	TAVO LED DO 12W-NW	254	36671	IQ-LED A60 3,4W-NW	40
36513	TAVO LED DO 18W-NW	254	36672	IQ-LED A60 3,4W-CW	40
36514	TAVO LED DO 24W-NW	254	36673	IQ-LED A60 5,9W-WW	40
36515	TAVO LED DL 5W-NW	254	36674	IQ-LED A60 5,9W-NW	40
36516	TAVO LED DL 9W-NW	254	36675	IQ-LED A60 5,9W-CW	40
36517	TAVO LED DL 12W-NW	254	36676	IQ-LED A60 7,8W-WW	40
36518	TAVO LED DL 18W-NW	254	36677	IQ-LED A60 7,8W-NW	40
36519	TAVO LED DL 24W-NW	254	36678	IQ-LED A60 7,8W-CW	40
36520	TAVO FRAME DO 12W	254	36679	IQ-LED A60 11W-WW	40
36521	TAVO FRAME DO 18W	254	36680	IQ-LED A60 11W-NW	40
36522	TAVO FRAME DL 12W	254	36681	IQ-LED A60 11W-CW	40
36523	TAVO FRAME DL 18W	254	36682	IQ-LED C35E14 3,4W-WW	56
36530	LIEGO 97 B	290	36683	IQ-LED C35E14 3,4W-NW	56
36531	LIEGO 89 PEND B	290	36684	IQ-LED C35E14 3,4W-VW	56
36532	LIEGO EL 28 UP B	290	36685	IQ-LED C35E14 5,9W-WW	56
36533	LIEGO EL 28 UP SE B	290	36686	IQ-LED C35E14 5,9W-NW	56
36534	LIEGO 37 B	290	36687	IQ-LED C35E14 5,9W-CW	56
36540	PRESO 80 GR	288	36688	IQ-LED G45E14 3,4W-WW	60
36541	PRESO 50 GR	288	36689	IQ-LED G45E14 3,4W-NW	60
36542	PRESO 30 GR	288	36690	IQ-LED G45E14 3,4W-CW	60
36543	PRESO EL 18 GR	288	36691	IQ-LED G45E27 3,4W-WW	60
36545	LAVEN 80 GR	287	36692	IQ-LED G45E27 3,4W-NW	60
36546	LAVEN 50 GR	287	36693	IQ-LED G45E27 3,4W-CW	60
36547	LAVEN EL 28 SE-GR	287	36694	IQ-LED G45E14 5,9W-WW	60
36548	LAVEN EL 25 GR	287	36695	IQ-LED G45E14 5,9W-NW	60
36550	PEVO 80 GR	286	36696	IQ-LED G45E14 5,9W-CW	60
36551	PEVO 50 GR	286	36697	IQ-LED G45E27 5,9W-WW	60
36552	PEVO EL 25 GR	286	36698	IQ-LED G45E27 5,9W-NW	60
36555	SELTO 80 B	289	36699	IQ-LED G45E27 5,9W-CW	60
36556	SELTO 50 B	289	37150	ARGUS II CT-2114-AN	182
36557	SELTO EL 23 B	289	37151	ARGUS II CT-2114-BR/M	182
36560	USTI SP 2X7 GR	298	37152	ARGUS II CT-2114-C	182
36561	USTI SP 1X7 GR	298	37153	ARGUS II CT-2114-C/M	182
36565	VORA SP 20 GR	299	37154	ARGUS II CT-2114-G	182
36566	VORA EL 20 GR	299	37155	ARGUS II CT-2114-GM	182
36570	ABETE LED 60 GR	285	37156	ARGUS II CT-2114-W	182
36571	ABETE LED 80 GR	285	37157	ARGUS II CT-2115-AN	182
36572	ABETE LED EL 20 GR	285	37158	ARGUS II CT-2115-BR/M	182
36573	ABETE LED EL 20 SE-GR	285	37159	ARGUS II CT-2115-C	182
36585	DASTO 2S0C FR B	302	37160	ARGUS II CT-2115-C/M	182
36586	NASTO 2S0C FR B	302	37161	ARGUS II CT-2115-G	182
36591	STONO 390 N	296	37162	ARGUS II CT-2115-GM	182
36592	STONO 490 N	296	37163	ARGUS II CT-2115-W	182
36593	STONO 585 N	296	37165	TINY BORD DTO-B	164
36594	STONO 780 N	296	37166	TINY BORD DTO-B/G	164
36605	FL SOLNAR SLR 8W NW-B	269	37167	TINY BORD DTO-W	164
36606	FL SONE SLR M NW-GR	268	37168	TINY BORD DTO-W/G	164
36607	FL SONE SLR L NW-GR	268	37170	BLINGO 34W 3740 60WW	208
36630	ZEPO LFD-T02-B	202	37171	BLINGO 34W 4080 60NW	208

# INDEX NACH KANLUX CODE

## INDEX BY CODES

37172	BLINGO 34W 4080 60CW	208	37327	VAND LED 17,5W NW B	117
37173	BLINGO U34W 4080 60NW	208	37330	ARVOS LED 37W CCT B	120
37174	BLINGO 34W 4080 120NW	208	37331	ARVOS LED 37W CCT W	120
37175	BLINGO U34W 4080 120N	208	37335	SPN PANEL 60-62	209
37176	BLINGO 38W 4560 60NW	208	37335	SPN PANEL 60-62	211
37177	BLINGO 38W 4560 120NW	208	37336	SPN PANEL 120	209
37178	BLINGO 24W 4320 60NW	208	37336	SPN PANEL 120	211
37179	BLINGO U24W 4000 60NW	208	37337	CLIPS PANEL 60-62	209
37229	NEON MOUNTING CLIP	96	37337	CLIPS PANEL 60-62	211
37230	LCOB 10W/M 12 IP00-WW	83	37338	CLIPS PANEL 120	209
37231	LCOB 10W/M 12 IP00-NW	83	37338	CLIPS PANEL 120	211
37232	LCOB 10W/M 12 IP65-WW	83	37340	XLEDEX C35E14 3,8W-WW	57
37233	LCOB 10W/M 12 IP65-NW	83	37341	XLEDEX C35E14 3,8W-NW	57
37234	NEON LED12W/M IP65-WW	96	37342	XLEDEX G45E14 3,8W-WW	61
37235	NEON LED12W/M IP65-NW	96	37343	XLEDEX G45E14 3,8W-NW	61
37236	NEON LED12W/M IP65-CW	96	37344	XLEDEX G45E27 3,8W-WW	61
37237	NEON LED12W/M IP65-BL	96	37345	XLEDEX G45E27 3,8W-NW	61
37238	NEON END CAP HOLE	96	37346	XLED HP D90E27 26W-NW	98
37239	NEON END CAP	96	37347	XLED HP D46E40 38W-NW	98
37240	XLEDI M A60 E27 11W-WW	47	37360	SQMOTION-W	322
37241	XLEDI M A60 E27 11W-NW	47	37361	SQMOTION-B	322
37242	XLEDI M A60 E27 11W-CW	47	37362	ALER N-W	322
37243	XLEDI M A60 B22 12W-WW	48	37363	ALER N-B	322
37244	XLEDI M A60 B22 12W-CW	48	37364	ZONA MINI-W	323
37250	FELINE DSO B/B	158	37365	ZONA MINI-WT-W	323
37251	FELINE DSO G/B	158	37366	SENTO-O-WT-W	324
37252	FELINE DSO W/B	158	37367	SENTO-O-WT-B	324
37253	FELINE DSO W/W	158	37368	SENSQUARE-W	324
37254	FELINE DSO G/W	158	37369	SENSQUARE-B	324
37255	FELINE DSO B/W	158	37370	MERGE-WT-O-W	325
37256	FELINE DSL B/B	159	37380	XLED W A60 8,5W-WW	55
37257	FELINE DSL G/B	159	37381	XLED W ST 64 7W-WW	55
37258	FELINE DSL W/B	159	37382	XLED W C35E14 4,5W-WW	55
37259	FELINE DSL W/W	159	37383	XLED W G45E14 4,5W-WW	55
37260	FELINE DSL B/W	159	37390	CALIZA LED CCT W	142
37261	FELINE DSL G/W	159	37392	IRS3xAAA LED PIR W-NW	200
37265	BLINGO U E125LM 60NW	210	37393	HOFI LED WW W	141
37266	BLINGO U E125LM 120NW	210	37394	ORISA LED WW W	141
37267	BLINGO DRV42W DALI BK	211	37395	ORISA LED WW B	141
37267	BLINGO DRV42W DALI BK	211	37396	ULOV LED DIM WW W	140
37268	BLINGO DRV40W1-10V BK	211	37397	BOLA LED 2xUSB WW W	140
37268	BLINGO DRV40W1-10V BK	211	70522	MILO 7040T	245
37269	BLINGO DRV 32W ON-OFF	211	70523	MILO 7040T/P	245
37269	BLINGO DRV 32W ON-OFF	211	70524	HERMI 7063NB	245
37270	BLINGO DRV 40W ON-OFF	211	70525	INES 7061N	246
37270	BLINGO DRV 40W ON-OFF	211	70910	CYKLON EOL 100	338
37271	BLINGO U E125LM 30NW	210	70911	CYKLON EOL 100B	338
37272	BLINGO DRV 24W ON-OFF	211	70915	CYKLON EOL 120	338
37272	BLINGO DRV 24W ON-OFF	211	70916	CYKLON EOL 120B	338
37290	IPER LED 10W-NW-O	230	70920	CYKLON EOL 150	338
37291	IPER LED 19W-NW-O	230	70921	CYKLON EOL 150B	338
37292	IPER LED 26W-NW-O	230	70926	TWISTER AOL100B	337
37293	IPER LED 35W-NW-O	230	70936	CYKLON EOL 100HT	338
37294	IPER LED 10W-NW-L	230	70937	CYKLON EOL 100P	338
37295	IPER LED 19W-NW-L	230	70938	CYKLON EOL 100T	338
37296	IPER LED 26W-NW-L	230	70941	CYKLON EOL 120HT	338
37297	IPER LED 35W-NW-L	230	70942	CYKLON EOL 120P	338
37298	IPER LED 10W-NW-O-SE	230	70943	CYKLON EOL 120T	338
37299	IPER LED 19W-NW-O-SE	230	70947	CYKLON EOL 150P	338
37300	IPER LED 26W-NW-O-SE	230	70948	CYKLON EOL 150T	338
37301	IPER LED 35W-NW-O-SE	230	70953	TWISTER AOL100T	337
37302	IPER LED 10W-NW-L-SE	230	70956	TWISTER AOL120B	337
37303	IPER LED 19W-NW-L-SE	230	70960	TWISTER AOL120T	337
37304	IPER LED 26W-NW-L-SE	230	70961	WIR ZL100	337
37305	IPER LED 35W-NW-L-SE	230	70962	WIR ZL120	337
37310	FLUXY LED IP44 W	146	72109	HLD-R-GX5,3	343
37311	FLUXY LED IP44 B	146	72333	CLP-REGIS/PT	216
37312	FLUXY LED IP44 BL	146	72333	CLP-REGIS/PT	217
37313	FLUXY LED IP44 GN	146	72369	BR-GZ10	340
37314	FLUXY LED IP44 Y	146	xxx	ALIN LED	16
37320	LUMKO LED 17,5W NW	114	xxx	ALIN LED LINE	18
37321	CARVO LED 17,5W NW	114	xxx	ALIN 4LED	20
37322	BONSA LED 17,5W NW	115	xxx	ALIN 4LED LINE	22
37323	EXATE LED 17,5W NW	115	xxx	OFIS S LED	24
37324	SOLN LED 17,5W NW B/G	116	xxx	HIERRO LED	26
37325	AMAZI LED 17,5W NW B	116	xxx	FUTURIO LED	28
37326	VAND LED 17,5W NW W	117	xxx	ADTR	30



**KANLUX SA**

ul. Objazdowa 1 - 3, 41 - 922 Radzionków  
POLSKA  
tel. +48 32/388 74 00  
fax +48 32/388 74 99  
e-mail: kanlux@kanlux.pl

**KANLUX LTD**

2703 Sugar Mill Business Park,  
Oakhurst Road, LS11 7HL Leeds  
UNITED KINGDOM  
salesuk@kanlux.com  
tel.: +44 (0) 7725249456

**KANLUX S.R.O.**

Sadová 618, 738 01 Frýdek-Místek  
ČESKÁ REPUBLIKA  
tel. +420 558 402 511, 603 504 218  
fax +420 558 694 250  
e-mail: kanlux.cz@kanlux.cz

**KANLUX S.R.O.**

Zlatovská 2179/28, 911 05 Trenčín  
SLOVENSKÁ REPUBLIKA  
tel. +421 327 446 385-6  
fax +421 327 446 387  
e-mail: kanlux.sk@kanlux.sk

**KANLUX KFT.**

9026 Győr, Bácsai út 153/b  
HUNGARY  
tel. +36 96 525-467  
fax +36 96 319-420  
e-mail: info@kanlux.hu

**ТОВ КАНЛЮКС**

08130, Київська область,  
Києво-Святошинський район,  
с.Петропавлівська Борщагівка, вул. Соборна,  
будинок 1-Б, офіс 617 УКРАЇНА  
тел. +38 (044) 585 33 19  
факс +38 (44) 585 33 18  
e-mail: kanlux\_ua@kanlux.com

**KANLUX LITHUANIA and LATVIA DISTRIBUTION**

tel. +37 065 693 649  
e-mail: donatas.pliura@kanlux.com

**KANLUX EOOD**

Warehouse area Gopet Logistics, 1532 Kazichene, Sofia  
BULGARIA  
tel. +359 2 421 96 24  
fax +359 2 421 96 23  
e-mail: kanlux.bg@kanlux.com

**KANLUX GMBH**

Flugplatz 21, 44319 Dortmund  
DEUTSCHLAND  
Tel. +49 231 56557255  
Fax +49 231 56557256  
e-mail: kanlux.gmbh@kanlux.com

**KANLUX LIGHTING SRL**

Kanlux Lighting S.R.L.Oltenitei 249  
Popesti Leordeni, 077160, Ilfov,  
ROMANIA  
tel. +40 371 474 133  
e-mail: comenzi@kanlux.com

**KANLUX FRANCE SAS**

224 bis, rue Marcadet,  
75018 Paris  
France  
tel. +33 (0) 9 86 23 98 61  
e-mail: kanlux.fr@kanlux.com

**KANLUX ITALY DISTRIBUTION**

mob. +39 (0) 339 833 78 00  
e-mail: kanlux.it@kanlux.com

more than  
light.

**RECHTLICHER HINWEIS**

Die vorliegende Publikation wurde durch Kanlux SA (AG) vorbereitet. Durch die ständige Optimierung unseres Angebots und dessen Anpassung an die Marktanforderungen und rechtliche Anforderungen behält sich Kanlux SA das Recht vor, Änderungen in das Sortiment einzuführen.

Die präsentierte Publikation ist kein Angebot im Sinne des polnischen Zivilgesetzbuches. Die realen Produkte können von den in der Publikation enthaltenen Fotos und -Zeichnungen abweichen. Alle in der Publikation enthaltenen Angaben entsprechen dem Stand bei Drucklegung, d.h. am 2nd of November 2023.

Kanlux SA haftet nicht für die fehlende Verfügbarkeit der in der vorliegenden Publikation aufgeführten Produkte. Kanlux SA übernimmt auch keine Haftung für irgendwelche unmittelbaren, mittelbaren, zufälligen oder irgendwelche anderen Schäden (darunter auch, aber nicht ausschließlich, für verlorene Vorteile, Einnahmen oder ähnliche wirtschaftliche Verluste), die aus der Nutzung der in dieser Publikation enthaltenen Informationen resultieren.

Kanlux SA behält sich auch das Recht zu Fehlern und zum Vornehmen der Änderungen im Druck vor.

**LAW NOTICE**

This publication has been prepared by Kanlux SA.  
Through the continuous improvement of its offer and adaptation of it to market and legal requirements, Kanlux SA reserves the right to make changes in its product mix.

This publication is not an offer within the meaning of the Civil Code. Actual products may differ from illustrative photos and drawings included in the publication. All of the data contained in the publication is in force on the date of printing i.e. 2nd of November 2023.

Kanlux SA shall not be liable for the non-availability of products listed in this publication. Kanlux SA also shall not be liable for any direct, indirect, accidental or any other damages (including, but not limited to, lost profits, lost revenues or similar economic losses) arising out of the use of information contained in this publication.

Kanlux SA reserves the right for errors and changes in print.



[kanlux.com](http://kanlux.com)

